

LIDIA BURZYŃSKA *, EWA RUDNIK *

THE INFLUENCE OF SACCHARIN AND SODIUM LAURYL SULFATE ON THE ELECTRODEPOSITION PROCESS OF Co-Ni ALLOYS

WPLYW SACHARYNY I LAURYLOSIARCZANU SODU NA PROCES KATODOWEGO OSADZANIA STOPÓW Co-Ni

Co-Ni alloys, obtained as a result of cathodic codeposition, are characterised by high strength, hardness and good corrosion resistance. Depending on the bath composition and the electrolysis parameters it is possible to obtain alloys of various composition, and consequently having different physical properties. The present paper contains the results of the study of the influence of additional substances (saccharin, sodium lauryl sulfate) on the composition and morphology of Co-Ni alloys and cathodic current efficiency. The experiments were carried out under galvanostatic conditions in Watts-type electrolyte.

Stopy Co-Ni otrzymywane na drodze katodowego współosadzania charakteryzują się wysoką wytrzymałością, twardością oraz dobrą odpornością na korozję. W zależności od składu kąpeli i parametrów elektrolizy można uzyskać stopy o różnym składzie, a tym samym o różnych własnościach fizycznych. W pracy przedstawiono wyniki badań wpływu substancji dodatkowych (sacharyna, laurylosiarczan sodu) na skład i morfologię stopów Co-Ni oraz katodową wydajność prądową. Pomiary prowadzono galwanostaticznie w elektrolicie typu Wattsa.

1. Introduction

The cathodic deposition of Co-Ni alloys has been studied by numerous authors [1–6]. The interest in this topic stems from the wide practical applicability of these materials [2, 3] as well as the interesting course of the cathodic process itself [4, 5]. The majority of papers describe predominantly the dependence of the composition

* AKADEMIA GÓRNICZO-HUTNICZA, WYDZIAŁ METALI NIEŻELAZNYCH, ZAKŁAD CHEMII FIZYCZNEJ I ELEKTROCHEMII, 30-059 KRAKÓW, AL. MICKIEWICZA 30

and properties of alloys on the cathodic current density, the concentration of Co^{2+} and Ni^{2+} ions in the electrolyte and on the pH of the bath. They pay considerably less attention to the influence of additional substances on the deposition process [6]. Thus, the present study was undertaken to determine the influence of two substances — saccharin and sodium lauryl sulfate — on the composition of cathodic deposits, the macroscopic properties thereof and on cathodic current efficiency. Saccharin is one of the most popular additives used in contemporary electrolytes for bright nickel plating [7]. It is applied to lower the internal stresses of cathodic coatings and as a brightening substance. Sodium lauryl sulfate, in turn, is a surfactant that prevents the formation of pits on the surface of the cathode as a result of the coevolution of gaseous hydrogen by facilitating bubbles liberation during electrolysis.

2. Experimental

Using data given in the literature [8, 9] we selected the composition of the electrolytes. Consequently, the codeposition of cobalt and nickel was carried out in Watt's-type baths with a pH value of 4.4 with and without the addition of saccharin (SAC) and/or sodium lauryl sulfate (SLS). Boric acid was used as the buffer substance. The composition of solution used during experiments is presented in table. Solutions were prepared from pure reagents (POCh, Poland) and distilled water. Rectangular stainless steel plates (5 cm × 6 cm) were used as the cathode substrates, Separate nickel (99.9%) and cobalt (99%) anodes with the same dimensions as the cathode were used. The nickel anodes were made of rolled plates, while the cobalt anodes — casted plates. The deposition of alloys was conducted in a cuboid rigid polyvinyl chloride vessel containing 3 dm³ of the electrolyte. In the electrolyser, the electrodes were hanged vertically and parallelly with respect to each other. The potential of the cathode was measured with respect to the saturated calomel electrode, while subsequently the measured results were converted with respect to a normal hydrogen electrode. The pH value of the bath was monitored with a combined electrode connected to a pH-meter (Radelkis Laboratory Digital pH-meter OP-211/1). A peristaltic pump assured continuous flow of the electrolyte with the rate of circulation of 40 dm³/h. In order to ensure the precise determination of the charge that flowed through the circuit, independent copper coulometers connected in series with the electrodes were used. The scheme of the measurement circuit is presented in Fig. 1. All measurements were conducted under galvanostatic conditions. The polarisation curves were registered after a metallic layer on the cathode was obtained (deposition for 1 hour at 0.5 A/dm²). The curves were recorded at increasing and decreasing current densities until reproducible values were found. The cathodic current efficiencies were calculated on the basis of the mass of the deposit and coulometric data. The microstructure of alloys was examined by means of the scanning analysis. The deposits were dissolved in HNO_3 (1:1), and

subsequently the composition thereof was determined applying the AAS method (Perkin Elmer Atomic Absorption Spectrometer 3110). The alloys were evaluated visually and measurements of the brightness of obtained coatings were carried out using a Corning-EEL glossmeter, adopting a mirror surface as a standard with 100% brightness.

TABLE

Baths compositions

Bath symbol	$\text{NiCl}_2 \cdot 6\text{H}_2\text{O}$ g/dm ³	$\text{CoSO}_4 \cdot 7\text{H}_2\text{O}$ g/dm ³	H_3BO_3 g/dm ³	Saccharin g/dm ³	Sodium lauryl sulfate g/dm ³
NO	200	25	25	—	—
SLS	200	25	25	—	0.08
SAC	200	25	25	1	—
SAC+SLS	200	25	25	1	0.08

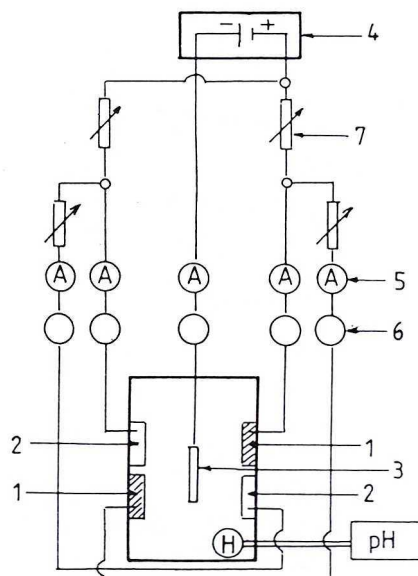

Fig. 1. Diagram of measurement circuit: 1 — cobalt anodes, 2 — nickel anodes, 3 — cathode, 4 — stabilised power supply, 5 — ammeters, 6 — copper coulometers, 7 — resistors, H — combined electrode, pH — pH-meter

3. Results and discussion

The cathodic polarisation curves of Co-Ni alloys were determined in electrolytes of different compositions (Fig. 2). It was established that in the presence of saccharin and/or sodium lauryl sulfate the curves shift towards more negative potentials in

comparison with the curve obtained in the electrolyte without additives. The greatest inhibition of the deposition process was observed in the case of saccharin ("SAC" curve). It may be suggested that this effect is connected with the strong adsorption of this compound on the cathode. The addition of sodium lauryl sulfate reduces the inhibitive effect of saccharin; the polarisation curve shifts towards more positive potentials ("SAC+SLS" curve). It may be an indication of the presence of competitive adsorption of the surfactant. However it displays a physical character, represented by the slight increase in the overvoltage of deposition of the alloy from

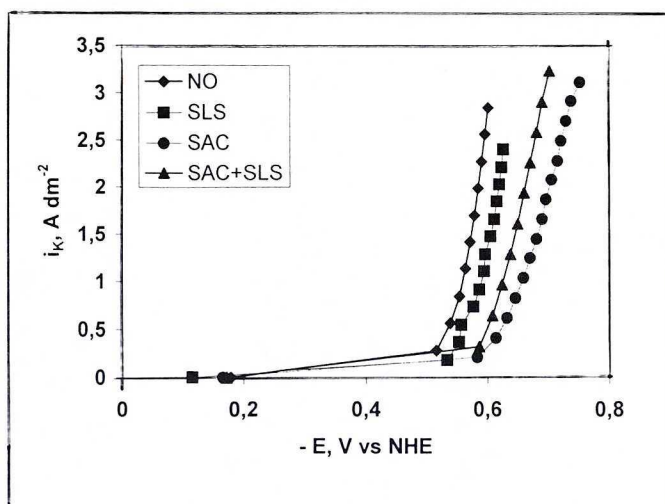

Fig. 2. Cathodic polarisation curves of Co Ni alloys

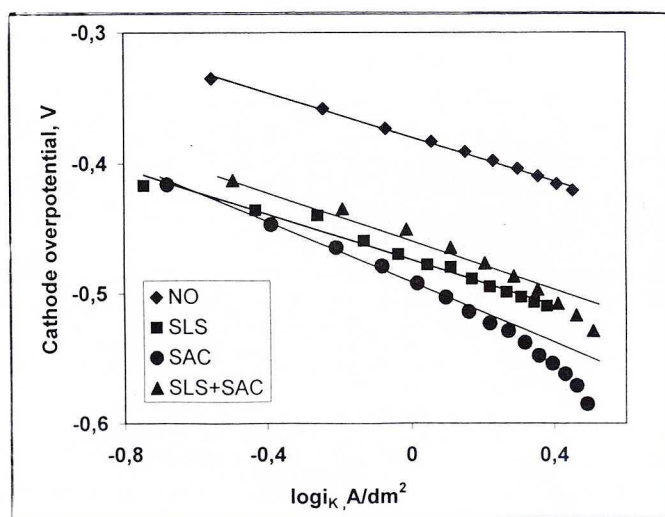

Fig. 3. Dependence of the cathode overpotential on the logarithm of the cathodic current density

a bath containing only sodium lauryl sulfate (“SLS” curve) in comparison with that obtained for electrolyte without additives (“NO” curve).

Fig. 3. presents the overvoltage of Co-Ni alloys deposition as a function of the logarithm of cathode current density. The data show that in the baths without additives or containing exclusively sodium lauryl sulfate, overvoltage is a linear function of the logarithm of cathodic current density (“NO” and “SLS” curves). This would appear to confirm the existence of activation control of the process under studied conditions. In the case of alloys deposition from solutions containing saccharin a deviation from linearity for the cathodic current densities higher than 2 A/dm^2 (“SAC” and “SAC+SLS” curves) is observed. This fact may be an indication of the increasingly evident participation of the concentration polarisation.

The presence of saccharin distinctly influences the composition of cathodic deposits — it leads to the enrichment of alloys in nickel for a given current density (Fig. 4).

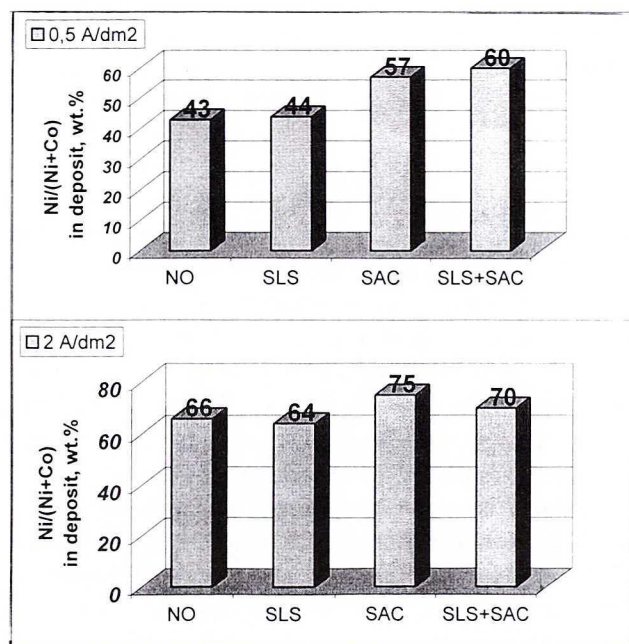

Fig. 4. The influence of additives on the composition of Co-Ni alloys

It is a well-known fact that the deposition of Co-Ni alloys displays an anomalous character, i.e. that the Co/Co + Ni ratio in the coating is greater than that in the bath [10]. For example 7 wt.% of cobalt in the electrolyte corresponds to 30 wt.% content of this metal in the cathodic deposit. This fact cannot be explained by the appearance of the gradients of concentration of Co^{2+} and Ni^{2+} in the diffusion layer, since the process takes place in the activation control area (Fig. 3). One of the

possible reasons of this anomalous deposition of the Co-Ni alloy is the precipitation of cobalt hydroxide as a result of an increase of the pH value in the cathode compartment and its adsorption on the surface of the electrode [11]. The precipitation of cobalt hydroxide is connected with the considerably lower value of its solubility product ($1.6 \cdot 10^{-18}$) than that of nickel hydroxide ($1.6 \cdot 10^{-14}$) [12]. At Ni^{2+} ions concentration of 0.9 mol/dm^3 in the bath, the nickel hydroxide precipitates at pH of about 7. In turn, at Co^{2+} ions concentration of 0.09 mol/dm^3 the cobalt hydroxide precipitates at pH of 5.5; an increase of pH value at the cathode surface to 5.5 during electrolysis seems very likely*. This precipitation leads to a considerable inhibition of the process of reduction of Ni^{2+} ions.

Data given in the literature [13] on the influence of saccharin on the process of the cathodic reduction of nickel show that this additive decreases the rate of formation of a dispersion phase consisting of basic nickel compounds in the cathodic area. At the same time newly formed nickel compounds with saccharin or one of products of its decomposition on the cathode [7], are characterised by a smaller adsorbing capacity on the cathode in comparison with nickel hydroxide. By analogy, we may suggest that saccharin interacts similarly with cobalt ions. As a result, the process of precipitation of cobalt hydroxide and the adsorption thereof on the cathode is inhibited, and consequently the reduction of Ni^{2+} ions is no longer blocked. An alloy with a higher fraction of nickel is deposited in comparison with coatings obtained from a bath not containing saccharin.

It was observed during investigations of the influence of the cathodic current density on the composition of Co-Ni alloys (Fig. 5) deposited from baths without saccharin, that the nickel content increased along with cathodic current density. It should be noted that this dependence is linear ("NO" and "SLS" curves). It is the characteristic feature that in the presence of saccharin and under current densities higher than 2 A/dm^2 the deposition of alloys having practically identical compositions occurs ("SAC" and "SAC + SLS" curves). This may be connected with the occurrence of the concentration polarisation in this range of current densities.

The composition of alloys deposited at a given current density (Figs 4 and 5) was characterised by a very good reproducibility. Observed difference between nickel content in the deposits was about 1%.

Fig. 6 presents the dependence of cathodic current efficiencies on current density and the presence of additives in the electrolyte. It was established that the processes of Co-Ni alloys deposition proceed with an extremely high current efficiency both in the electrolyte without additional substances ("NO" curve), and in solutions containing sodium lauryl sulfate ("SLS" and "SAC + SLS" curves). Only in the case of a bath containing solely saccharin, a rapid fall in current efficiency for the current densities higher than 1 A/dm^2 ("SAC" curve) was observed. This was caused by an increase in the cathodic evolution of hydrogen.

* Despite of the H_3BO_3 presence the bath has the tendency to alkalify. The constant pH was maintained by periodic addition of a few drops of a mixture of HCl and H_2SO_4 .

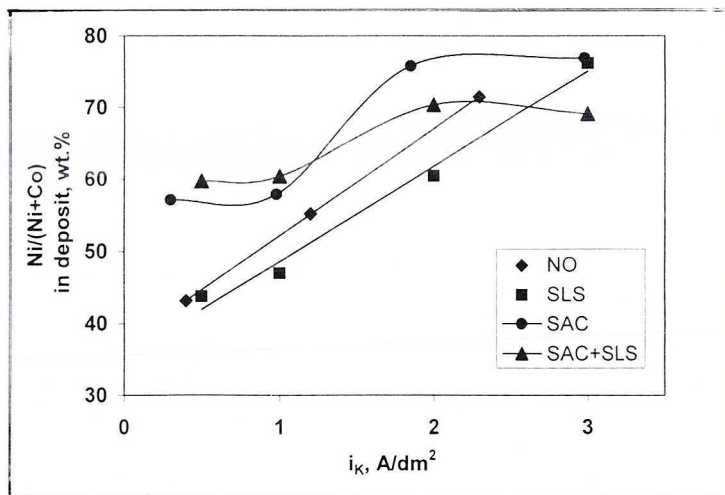

Fig. 5. Dependence of the composition of Co-Ni alloys on the cathodic current density

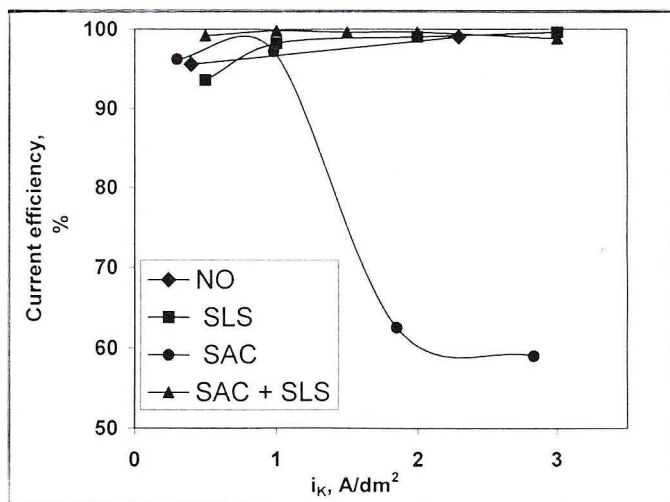

Fig. 6. Dependence of the cathodic current efficiency upon current density

In the both containing only SAC, the difficulty of gas bubbles to escape from the deposit causes the pits on the cathode surface. In the presence of a surfactant the liberation of hydrogen bubbles is considerably easier and thus the alloy surface is smooth.

Saccharin belongs to the group of brightening compounds [7]. Their effect consists in adsorbing molecules on the cathode surface. This leads to an inhibition of the growth of crystallisation nuclei and the formation of fine-grained coatings with highly uniform surfaces (Fig. 7 a), and thus with a relatively high brightness (40–59%). Surface of alloys obtained in electrolytes without additives or containing

exclusively sodium lauryl sulfate was grey and matt, with relatively large spherical growths (Fig. 7b), the presence of which decreases the brightness of the coatings (0%).

Saccharin lowers the internal stress of cathodic deposits. Coatings obtained from electrolytes with the addition thereof were characterised by extremely good adherence to the substrate, while alloys deposited in baths without additives or in the presence of sodium lauryl sulfate exclusively, separated spontaneously from the cathode substrate and cracked even in the course of electrolysis.

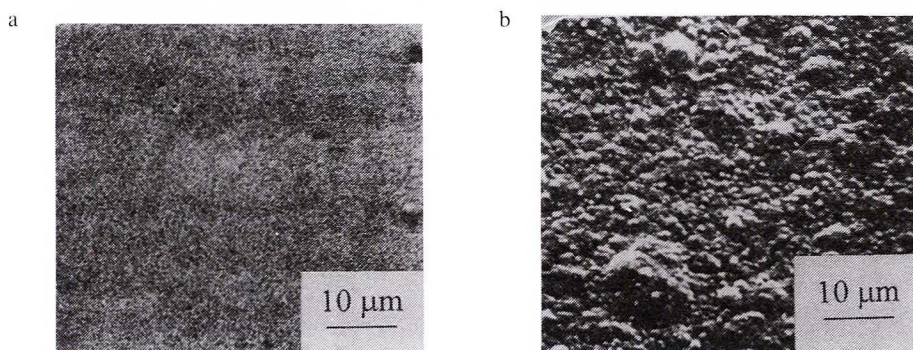

Fig. 7. Microphotographs of Co-Ni alloys surfaces obtained at 1 A/dm^2 in the baths: a) "SAC" and "SAC+SLS" b) "NO" and "SLS"

4. Summary

Results of our measurements indicate that the simultaneous presence of saccharin and sodium lauryl sulfate exerts a favourable influence on the quality of deposited Co-Ni alloys, with saccharin exerting the greatest influence on the cathodic process. It was found that saccharin:

1. increases cathodic polarisation, which leads to the deposition of alloys which are fine-grained and thus having a high brightness,
2. lowers the internal stress of coatings, which ensures that they are characterised by good adherence to the substrate,
3. increases the fraction of nickel in obtained alloys.

In turn, the presence of sodium lauryl sulfate prevents the formation of pits on the surface of the cathode as a result of the coevolution of gaseous hydrogen.

Acknowledgement

This research work has been supported by KBN (Grant No 7 T08D 031 15).

Keynote paper presented at the Science and Technology of Metallic Materials, in frame of the *IVth International Conference on Non-Ferrous Metals and Alloys '99*, June 24–25, 1999, on occasion of the 80th anniversary of the University of Mining and Metallurgy, Cracow, Poland.

REFERENCES

- [1] S. N. Srimathi, S. M. Mayanna, B. S. Sheshadri, Surf. Technol., **16**, 277 (1982).
- [2] W. R. Wearmouth, K. C. Belt, Trans. IMF **52**, 114 (1974).
- [3] A. Hart, Materials Edge **18**, 15 (1990).
- [4] K. Y. Sasaki, J. B. Talbot, J. Electrochem. Soc. **142**(3), 775 (1995).
- [5] C. Fan, D. L. Piron, Electrochim. Acta **41**(10), 1713 (1996).
- [6] R. D. Srivastava, S. K. Nigam., Surf. Technol. **10**, 343 (1980).
- [7] D. Mockute, Chemija **1**, 17 (1995).
- [8] S. S. Abd El-Rehim, A. M. Abd El-Halim, M. M. Osman, J. Appl. Electrochem **15**, 107 (1985).
- [9] J. Przyłuski, J. Bieliński, M. Kucharski, Surf. Technol. **9**, 179 (1979).
- [10] A. Brenner, Electrodeposition of alloys, Academic Press, New York-London (1963).
- [11] H. Dahms, I. M. Croll, J. Electrochem. Soc. **112**, 771 (1965).
- [12] Poradnik fizykochemiczny, WNT Warszawa (1962).
- [13] O. K. Galdikene, B. J. Ukyalene, Y. Y. Matulis, Liet. TSR Mosklu. Akad. Darb. Ser. B. **4**(59), 65 (1969).

REVIEWED BY: PROF. DR HAB. INŻ. JERZY SĘDZIMIR

Received: 12 April 2000.