

Introduction to the investigation of reproduction of the real geometry of UBM panels

Ryszard WALENTYŃSKI¹ , Robert CYBULSKI² , and Henryk MYRCIK¹ *

¹ Silesian University of Technology, Faculty of Civil Engineering, Akademicka 5, 44-100 Gliwice, Poland

² MERAENG Sp. z o.o. sp. k, W. Wróblewskiego 31a, 41-106 Siemianowice Śląskie, Poland

Abstract. The article concisely describes UBM technology (Ultimate Building Machine), that can be used as a solution for buildings and roof structures. The structure of this technology is made of double corrugated thin-walled steel profiles manufactured on the construction site by a self-contained UBM manufacturing factory on wheels. These panels serve as both the building envelope and the structural system. The specificity of the construction poses many design problems, especially the determination of the strength parameters and stiffness of the double-corrugated panels from which the structure is made. The article presents the results of spatial scanning tests of double-corrugated steel sheets, which were carried out using commonly available 3D scanning devices: Leica 3D Disto and MagiScan app. Additionally, results of numerical analyses performed on scanned samples and a comparison of these results with preliminary laboratory tests are presented in the article. The purpose of scanning was to obtain an accurate and real geometry of the UBM panels, to implement it into numerical software, and then to perform numerical analyses. Commonly available 3D scanning devices were used because using advanced 3D scanners is not popular nowadays for economic reasons, and hand-built geometric models pose a lot of problems and are not accurate enough. The obtained results are promising and form the basis for further research.

Keywords: UBM; K-span; thin-walled panels; 3D scanning, arch structures, double corrugated steel sheets.

1. INTRODUCTION

The present construction industry tends towards raising ever more lightweight, economical, and therefore cheaper structures. Current automation spreading all over the world creates many possibilities for investors who want to build as many unusual and functional structures as possible in the shortest possible time. The UBM technology (Ultimate Building Machine), which is a type of K-span arch structure, perfectly meets their expectations, which is why it enjoys a constantly growing popularity in the Polish and foreign markets. Unfortunately, there is no valid method to design arched buildings made of double corrugated steel sheets. This was highlighted in a recently published article [1] that reviewed the latest advances in approaches to assess the load capacity and stability of K-span structures. The risk of failure and collapse of this type of building was also highlighted as a consequence of errors and incorrect assumptions made during the design process. This study aims to introduce UBM technology to the public and to present computational model definition methods for double-corrugated UBM panels that have been recently tested by the authors of this article.

2. K-SPAN SYSTEM, UBM TECHNOLOGY

The K-span system is a solution for self-supporting, truss-less, arched roofs and buildings. Structures are made of panels that serve both as the building envelope and the structural system,

providing a very cost-effective, rapid, and easy solution for erecting buildings. The K-span system does not require conventional steel frames and purlins on which roofing sheets are installed. Initially, the technology was widely used by the US military to construct temporary buildings. Today, it has become popular in civil construction as a solution for air docks, temporary halls, sports halls, and others. There are many varieties of arched hall systems in the world market, and some of them are becoming increasingly popular in the Polish market. Most of them are prefabricated in production plants. The arch elements are delivered to the construction site, each of which is perforated and ready to be screwed together. The American company M.I.C. Industries [2] offers interesting ABM and UBM systems, which are the only ones that are erected entirely in the final place of construction of the hall. Arched structures, both in ABM and in UBM, are manufactured on the construction site by a self-contained factory on wheels that can be easily transported by truck or airplane. The ABM (Automatic Building Machine) is the first system from M.I.C. Industries Inc. was implemented mainly for the US Army needs.

The UBM (Ultimate Building Machine) is an improvement to the previous ABM system. The UBM technology enables the erection of structures of various shapes of the building. The previous system (ABM) enables the design of an arched shape whose structure radius is constant throughout its length. Although UBM technology allows one to determine basically any shape of the structure cross-section, as shown in Fig. 1. Analogously to the ABM technology, the UBM is manufactured mostly in two-panel cross-section variants: 120 and 240, as shown in Fig. 2. The UBM technology building is constructed

*e-mail: Henryk.Myrcik@polsl.pl

Manuscript submitted 2024-03-18, revised 2024-06-28, initially accepted for publication 2024-10-04, published in January 2025.

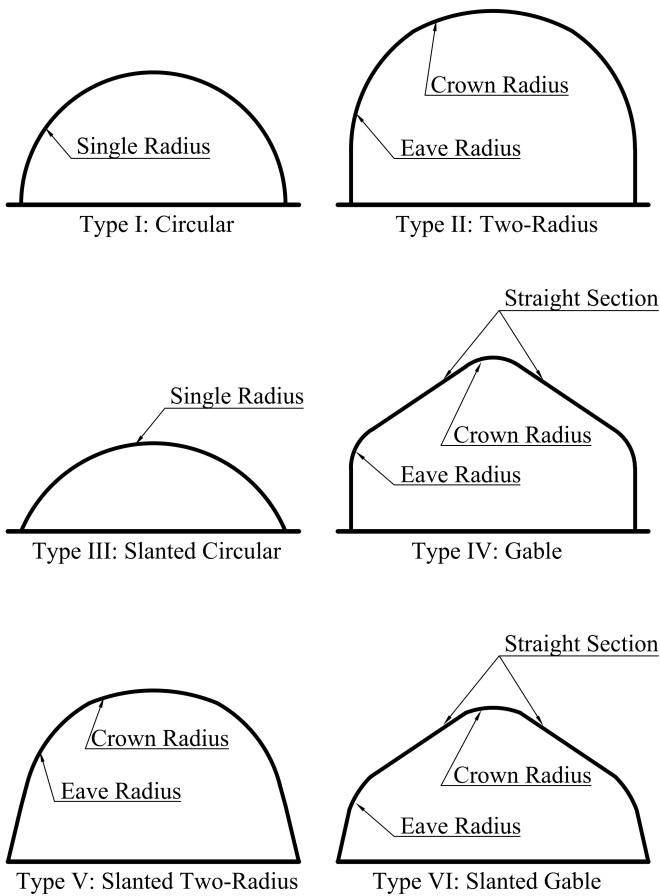

Fig. 1. Possible UMB buildings shapes

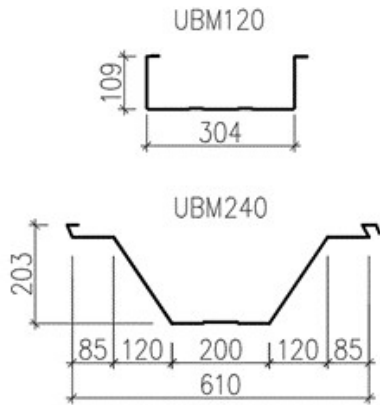

Fig. 2. Cross-sections of the UMB profiles

in the same way as the ABM technology. First, utilizing the M.I.C.'s mobile factory, a coil of steel is formed into a straight panel of channel cross-section by the cold-rolling method. This panel is cut to achieve the span needed for the future arch building. The UBM factory is shown in Fig. 3. The first stage of the UBM technology process is shown in Fig. 4. Thereafter, those panels are curved by transverse corrugation of the flanges and web, which allows for obtaining a circular arch shape with the right radius (Fig. 5). The curved panels are assembled in groups

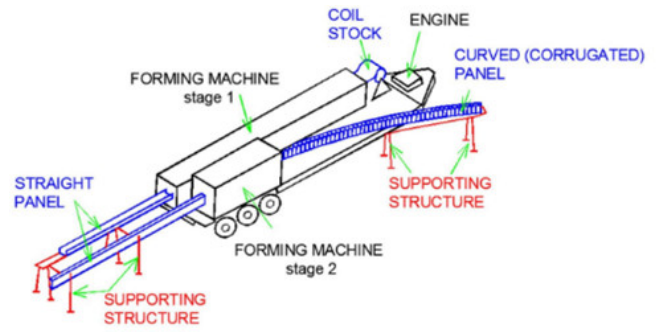

Fig. 3. Prefabrication UBM machine



Fig. 4. First stage of UBM technology process



Fig. 5. Second stage of UBM technology process

of a few panels by a seam machine, as shown in Fig. 6. Then they are fixed to a lifting sling and transported to the execution place by a crane (Fig. 7). In Fig. 8, based on [3] and [4], warehouses and sports halls are presented as examples of existing arches, and self-supporting buildings.

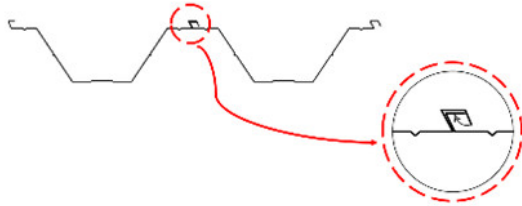

Fig. 6. Merging UBM panels by seam machine



Fig. 7. Assembly of group of UBM panels

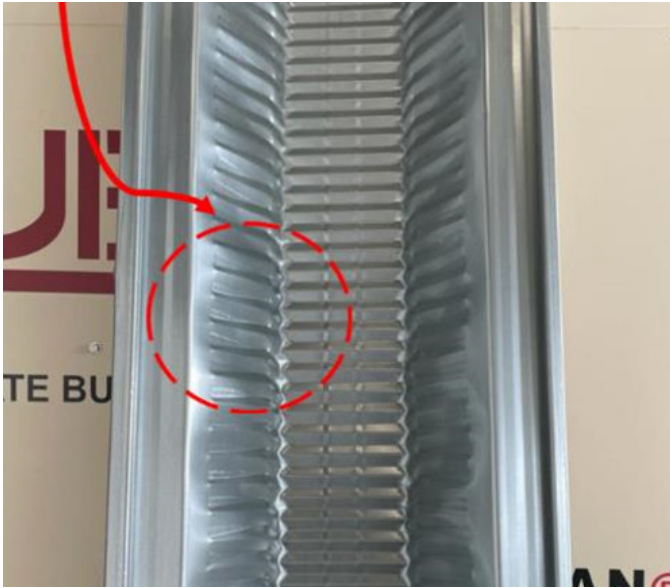

Fig. 8. Examples of the arch buildings

3. SCANNING 3D

As noted in [1], the corrugated shape of the UBM panels described above is a considerable difficulty to analyse and design. When calculating structures made of cold-formed elements, it is necessary to define the effective parameters of the cross sections, while neither European [5–7] nor American [8], nor Canadian standards provide guidelines for determining the load-bearing capacity of curved elements with transverse corrugation. The standards do not consider transverse geometric imperfections and provide calculation procedures only for thin-walled elements with straight walls. The authors' experience shows that panel corrugations are neglected by construction designers in everyday engineering work and are treated as a reinforcement of the element. However, in the article [9], the much lower flexural stiffness of curved panels compared to straight panels has already been observed. The article points out the significant impact of curvature and corrugations on the strength and stiffness of the panels in compression. Therefore, it is recommended to determine the load-bearing capacity and stiffness of double-corrugated UBM profiles by conducting an experimental inves-

tigation or FEM analysis. The theoretical definition of panel geometry for FEM analysis is difficult for structural designers. Providing the geometry of panels with a small bend radius is particularly complicated due to the longitudinal ripples on the side walls. Figure 9a shows a panel of 1.00 mm thick made of steel S350GD+Z, for which the bend radius was 5.00 m. The side walls are rippled along the entire length of the panel. An example of an imperfection is shown in Fig. 9a. Figure 9b depicts a panel made of the same material ($t = 1.00$ mm S350GD+Z), for which the radius of the bend was 10.00 m. There are no additional imperfections on this panel. The preliminary tests carried out by the authors of this article, on samples made of S350GD+Z steel with a thickness of 1.00 mm, indicated the bend radius $R = 8.00$ m as the limit radius, below which ripples appear on the side walls. The highest waves were observed for the panel with a minimum bend radius, i.e. $R = 4.57$ m (15 feet). In the future, more research will be conducted on this issue and its impact on behaviour. In [10], the optical scanning method is presented as a method to map the exact and real geometry of the ABM 120 panel and convert it into a numerical model. As



(a)

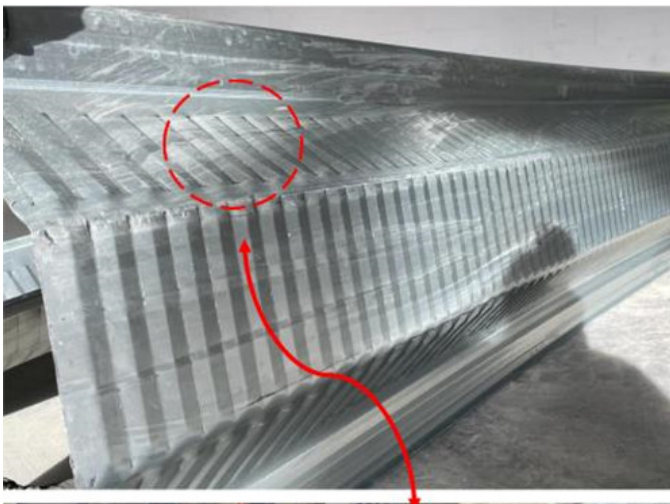

(b)

Fig. 9. (a) UBM 240 panel with a radius $R = 5.00$ m;
(b) UBM 240 panel with a radius $R = 10.00$ m

shown in [11], the scanning facilitated a good convergence of the results obtained from laboratory tests and numerical analyses. Therefore, UBM 240 panels were also scanned, but using different scanning devices. Commonly known, available, and much cheaper devices were used compared to those described in [10]. The purpose of the experiment is to verify the capabilities of

the selected devices in the field of spatial scanning. The UBM 240 panels were scanned using two devices. The first device is a Leica 3D Disto (Fig. 10), and the second is a smartphone-type device that is capable of performing a three-dimensional scan via the application called MagiScan [12]. Leica 3D Disto is a laser rangefinder with a scanning function. The Leica rangefinder is capable of measuring with an accuracy of up to 1.00 mm. This device is widely used by engineers, construction workers, and interior designers. The advantages of the device are automatic calibration, small size, and affordable price. The biggest convenience of Leica 3D Disto is that there is no need to provide a scan from different perspectives (there is no need to rotate the panels or move with the device). In addition, Leica has provided an application that enables one to preview the scanning results in real time. The second device, MagiScan, which is an artificial intelligence-based 3D scanning application, provides a scan using a camera built into a smartphone device. It requires access to the scanned item from all sides. The application transforms the scanned element into a 3D model that can be saved in for-

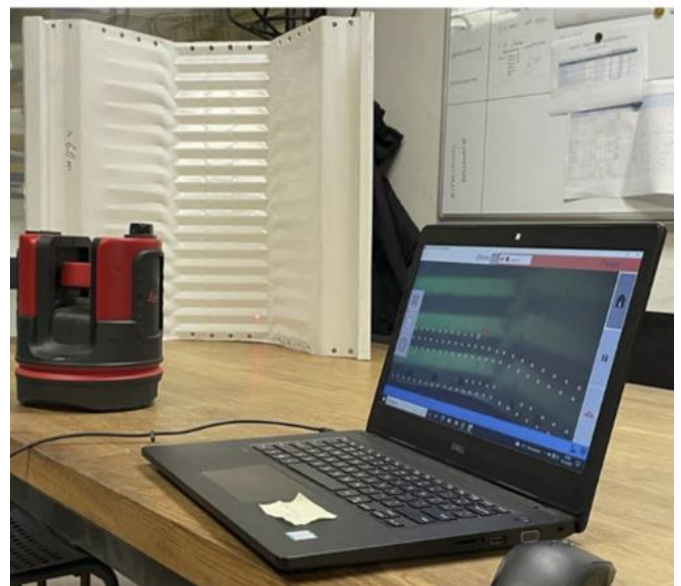

Fig. 10. 3D scanning of corrugated UBM 240 panel

Introduction to the investigation of reproduction of the real geometry of UBM panels

mats such as OBJ, STL, FBX, PLY, USDZ, GLB, and GLTF. The file saved with the above extension can be edited using software such as Autodesk Inventor, Autodesk Fusion 360, and Geomagic for SOLIDWORKS. Scanning an element using the application takes no more than a few minutes (it is much faster than scanning with the Leica 3D Disto). The application does not require additional devices or accessories. It is recommended to prepare the area around the scanned element as empty, uniform, and contrasting as much as possible in relation to the scanned element. The selected devices differ from the method of performing a spatial scan. The Leica 3D Disto scanner is a laser rangefinder, the operation of which is based on the emission of an electromagnetic pulse in the form of a laser beam. The laser beam is emitted by the optical-electronic system, then reflects from the measured surface, and returns to the measuring instrument. Rangefinder systems process the reflected laser beam and determine the measured distance. The device owes its high measurement precision to the operation of a system that measures distance by analysing the travel time of a section in two planes based on the measurement of the phase shift of the sent and returning EM wave. On the other hand, the MagiScan application recreates the shape of the scanned object based on photogrammetry (SFM, structure from motion), a process that calculates three-dimensional coordinates of points on the surface of a real object based on photographs taken from different angles. Knowing the camera position and direction, the application creates 3D points corresponding to the two-dimensional data in the image. Figure 11 shows a model of the panel obtained using the Leica 3D Disto. Figure 12 shows a model of the same UBM 240 panel with a radius of 6.00 m, scanned using MagiScan.

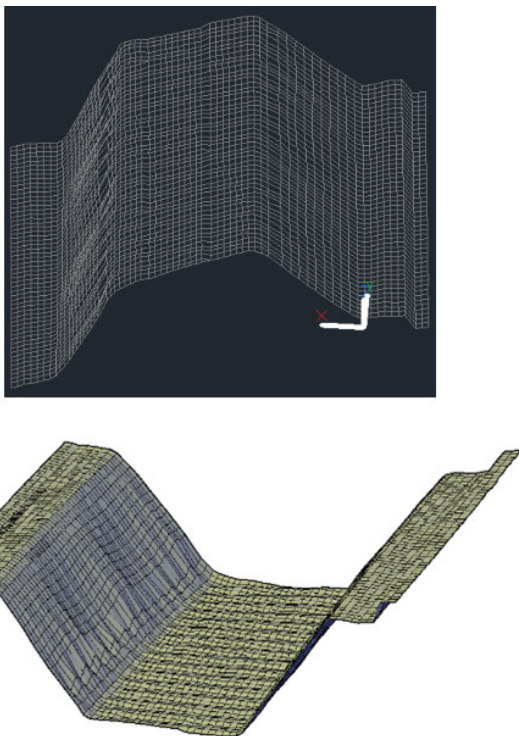
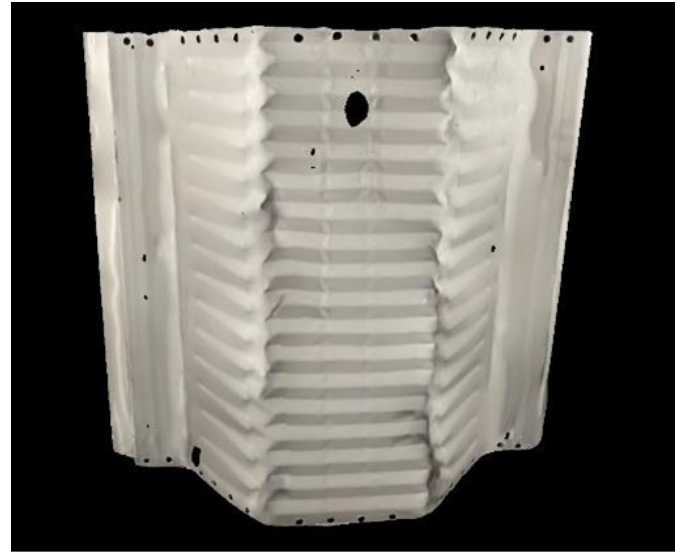
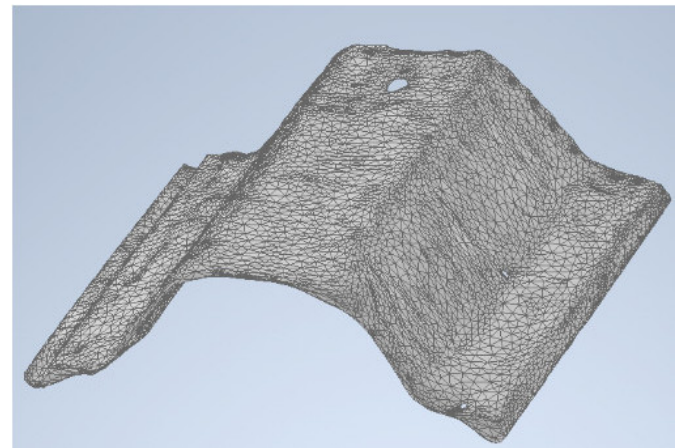

Fig. 11. UBM 240 panel – result of scanning by Leica 3D Disto



(a)



(b)

Fig. 12. UBM 240 panel – result of scanning by MagiScan: (a) model in MagiScan app, (b) the achieved path of girds in Inventor software

4. NUMERICAL ANALYSES

In the present section, we introduce a description of the numerical model of UBM panels together with a comparison of the results of the preliminary experimental investigation.

4.1. Numerical model properties

Numerical models are built from shell elements in the SCIA Engineer software [13], based on the geometry obtained from panel scanning and minor manual corrections to models in places where the scan was imperfect or incomplete. These places do not significantly affect the results obtained. The models are ~ 0.6 m long and curved in length along a radius of 6.00 m. The cores of the profiles are made of a 1.00 mm thick steel sheet (nominal thickness). The material properties are the following: steel grade: S350GD+Z, Young's modulus (E) and Poisson ratio (ν) are equal to 210 GPa and 0.3, respectively. The first two prepared models were based on the geometry obtained from a scan made with the Leica 3D Disto device. The next two models were

made for the same panels, but their numerical models were based on the geometry obtained from the scan made via the MagiScan application. The same boundary conditions as shown in Fig. 13 were assumed for all models. To reflect the end plate used in

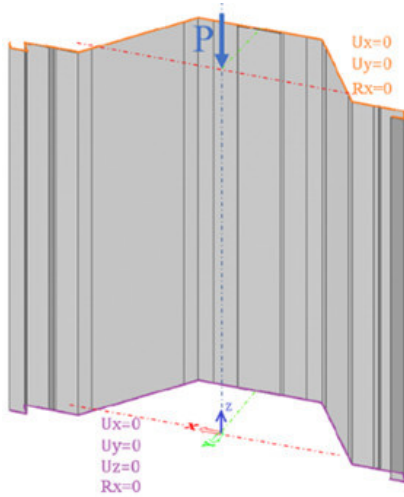

Fig. 13. Panel load and boundary conditions

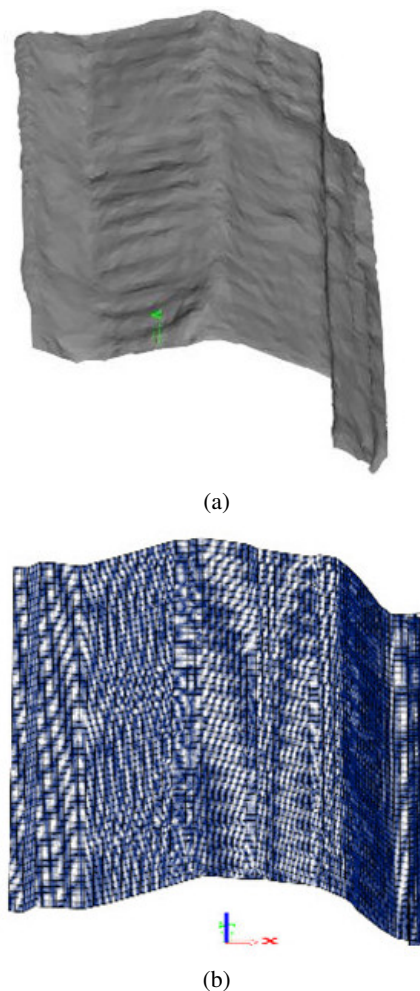

Fig. 14. FEM models of UBM panels in SCIA Engineer: (a) based on MagiScan model; (b) based on Leica model

the experimental tests, at each end of the panels, a rigid element (called a ‘rigid body’) was introduced. The concentrated axial compression load placed at the centre of gravity of the cross-section was applied at the end where BC $U_x = U_y = 0$ is used. The ‘rigid body’ element allowed us to transfer the compression force. A geometrically and materially nonlinear numerical analysis was performed for each model. Geometric and nonlinear material analysis was carried out using the modified Newton-Rhapson method. An isotropic, elastoplastic material model was used. The selected numerical models are shown in Fig. 14. The results obtained are presented in Fig. 15 in terms of stress distribution and failure deformation. Values will be presented after the final experimental investigations.

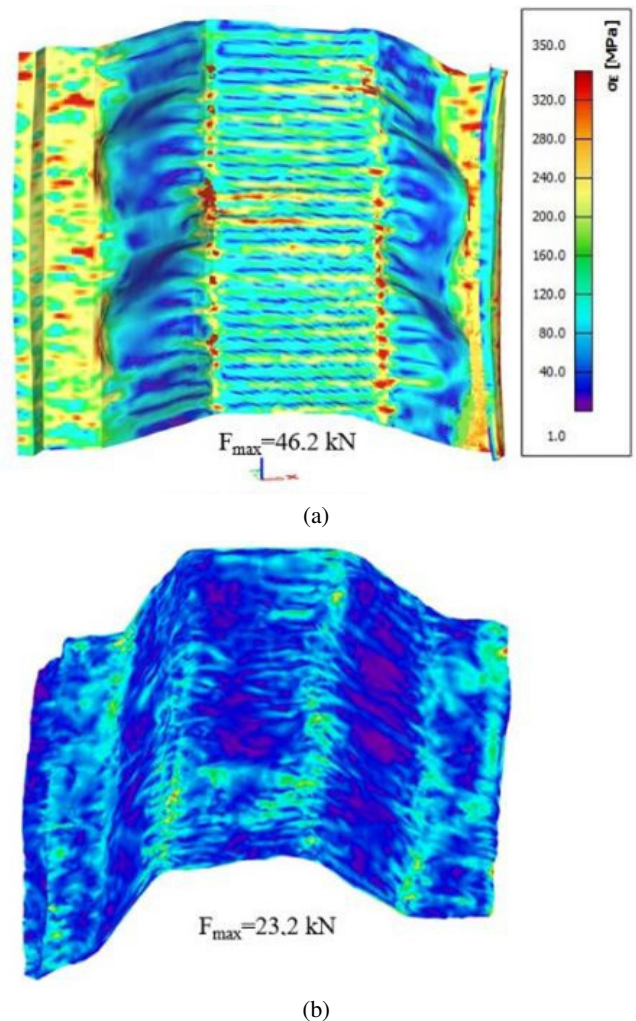

Fig. 15. Misses stresses distribution and deformations for ultimate load: (a) for model basis on Leica geometry; (b) for model basis on MagiScan model

4.2. Preliminary experimental investigation

Based on the experience included in an article [14], the axial compression tests of the curved panels were carried out in a laboratory that belongs to the Faculty of Civil Engineering of the Silesian University of Technology in Poland. The experimental investigation at this stage of the research must be called

preliminary and has only a qualitative meaning. The tests were carried out for UBM panels with length $L \approx 60$ cm, bend radius $R = 6.00$ m, thickness $t = 1.00$ mm, made of steel S350GD+Z. The research was investigated using the same panels as during the scanning described in Section 3. Compression tests were performed on a ZD100 hydraulic press. At each end of the sample, thick metal plates ($t = 15$ mm) were fixed due to load transfer. The loading rate was 10 kN/min. The load was applied to the thick plate as a concentrated force at the geometric centre of gravity of the panel cross-section as shown in Fig. 16. The test setup is presented in Fig. 17. The failure deformation of the tested panels is indicated in Fig. 18. The conducted tests are considered preliminary. There were two aims of the research. First, to verify the precision of the test setup and the test method. Second, to verify the results obtained from numerical analyses carried out on a model with geometry provided by 3D scanning using the above-mentioned devices. In this investigation, the analysis of numerical results (forces and deformations) is not described. It will be presented when the results of the target research are published.

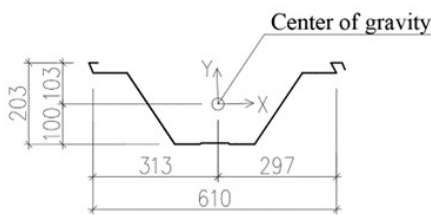

Fig. 16. Centre of gravity for UBM 240 profile ($t = 1.00$ mm)

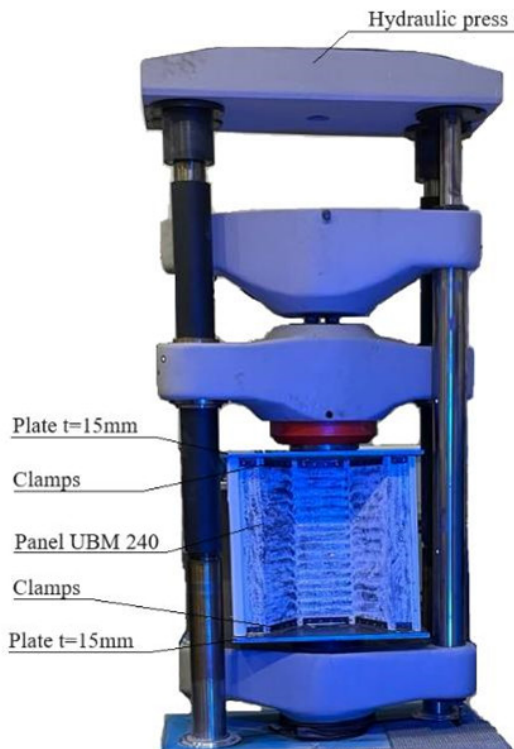
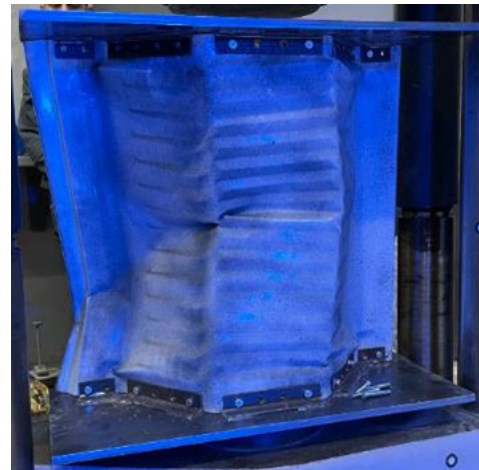

Fig. 17. Compression test set-up



(a)



(b)

Fig. 18. (a), (b) Preliminary tests – destroyed samples

4.3. Comparison of results

The stress distribution and the failure deformation for the numerical analysis based on the geometry obtained from the Leica 3D Disto scan are compatible with the results of preliminary laboratory tests, as shown in Fig. 19. The results for the model built on the geometry implemented from the MagiScan scanning differ significantly from the results received for the model based on scanning with the Leica rangefinder. They do not coincide with the results of the preliminary experimental investigation. The reason for the discrepancy is probably a local geometry complication, which was noticed in several places during the construction of the computational model. Currently, the results obtained disqualify the use of the MagiScan application as a tool based on the scan, which can be used to create a numerical model. However, following the development of technology, the authors do not reject this device. Furthermore, it was observed that the failure of the panels occurred in places analogous to those described in article [15], where transverse corrugations of

the web and the flat lip overlap in the opposite way, Fig. 20. In the paper [15] concerning ABM 120 panels, the place of damage was called ‘Achille’s heel’ of the self-supporting arch buildings.

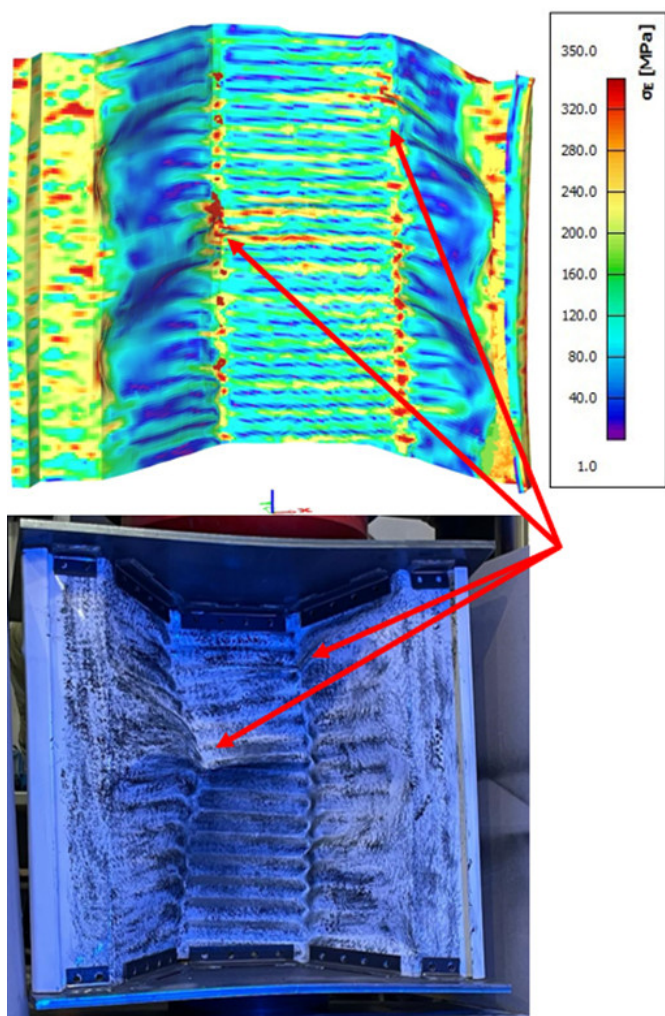

Fig. 19. Failure deformations: numerical, experimental

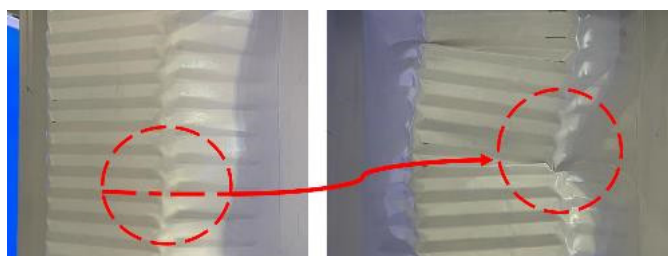

Fig. 20. Forms of failure – ‘Achilles heel’

5. CONCLUSIONS AND FUTURE WORK

This article briefly describes the prefabrication process of cold-formed panels in UBM technology. This system is used for the construction of self-supporting steel roofs and buildings. For thin-walled elements, a very important issue must be considered,

such as local stability behaviour. In the case of UBM panels, it is not possible to determine effective parameters according to European and other foreign standards; ignoring the corrugated surface is a common occurrence among structural designers and engineers. However, this is not a correct and safe approach and, as can be read in [16], it can lead to failure of the construction. Providing the real and accurate geometry of UBM panels in engineering calculations poses many problems, as described in this article. Some recent research consisting of FEM analysis carried out using a 3D scan, such as described in [11], indicated the possibility of obtaining calculation results that are consistent with laboratory tests. However, to the best of our knowledge, the scanning devices used during the research are cost intensive. The conclusion is that other 3D scans might be considered. In this paper, two widely available scanning methods were verified. The panels were scanned with a Leica 3D Disto laser rangefinder and with a smartphone device using the MagiScan application. The UBM panel geometry obtained from both scanning devices was implemented in the SCIA Engineer calculation program, and then a numerical analysis was performed. As written in Section 4.3 of this study, promising results were obtained for the computational model based on the geometry of the Leica 3D Disto scan. So far, the results obtained from the scans performed with the MagiScan application have not brought satisfactory results. The availability, ease, and speed of development of this application mean that it will be certainly the subject of further interest, and the authors of this study will attempt to use it. This consideration shows that performing numerical analyses based on 3D scans may soon become a common engineering practice, also in civil engineering, without the use of specialized equipment. Further research will be focused on laboratory tests of panel fragments and also on further numerical analyses. The purpose of the study will be to correlate the results obtained from laboratory tests with the results received from numerical analyses, which is a starting point for the beginning of full-scale testing of arches using UBM technology.

ACKNOWLEDGEMENTS

This article was financed by MERAENG Sp. z o.o. sp. k, W. Wróblewskiego 31a, 41-106 Siemianowice Śląskie.

REFERENCES

- [1] A. Piekarczyk, P. Więch, K. Kuczyński, and R. Walentyński, “Experimental and computational approaches to the evaluation of double corrugated arch structures. A review of the latest advancements”, *Arch. Civ. Eng.*, vol. LXVII, pp. 7–35, 2021, doi: 10.24425/ace.2021.137152.
- [2] M.I.C. Industries Inc, “The Ultimate Building Machine”, [Online]. Available: <https://www.micindustries.com> [Accessed: 28.02.2024]
- [3] “Develagro.” Globarch Sp. z O. O., [Online]. Available: <http://develagro.pl/> [Accessed: 28.02.2024].
- [4] “Attl Obloukove haly.” Attl et al. Ltd. Machine Factory. [Online]. Available: <https://www.haly-obloukove.cz> [Accessed: 28.02.2024]

Introduction to the investigation of reproduction of the real geometry of UBM panels

- [5] European Committee for Standardisation, EN 1993-1-1: Eurocode 3: Design of steel structures – Part 1-1: General rules and rules for buildings, 2005.
- [6] European Committee for Standardisation, EN 1993-1-3: Eurocode 3: Design of steel structures – Part 1-3: General rules – Supplementary rules for cold-formed members and sheeting, 2006.
- [7] European Committee for Standardisation, EN 1993-1-5: Eurocode 3: Design of steel structures – Part 1-5: Plated structural elements, 2006.
- [8] North American Specification for the Design of Cold-Formed Steel Structural Members, 2012.
- [9] L. Xu, Y. Gang, and P. Guo, “Compressive tests of cold-formed steel curved panels,” *J. Constr. Steel. Res.*, vol. 57, pp. 1249–1265, 2001, doi: [10.1016/S0143-974X\(01\)00048-7](https://doi.org/10.1016/S0143-974X(01)00048-7).
- [10] R. Walentyński, R. Cybulski, and J. Knappek, “Budowa modelu teoretycznego podwójnie giętych paneli cienkościennych typu ABM 120,” *Aparatura Badawcza i Dydaktyczna*, vol. 18, no. 1, pp. 17–24, 2013 (in Polish).
- [11] R. Walentyński, R. Cybulski, and K. Kozieł, “Local buckling and post-buckling investigation of cold-formed self-supported elements,” in *Proc. 20th International Conference on Computer Methods in Mechanics*, 2013, pp. 23–37, doi: [10.1201/b16513-6](https://doi.org/10.1201/b16513-6).
- [12] “3D MagiScan.” MagiScan Inc, [Online]. Available: <https://magiscan.app/> [Accessed: 28.02.2024].
- [13] “Scia by Allplan.” Nemetschek Group, [Online]. Available: <https://www.scia.net/en> [Accessed: 14.10.2024].
- [14] L.L. Wu, X. Gao, Y. Shi, and Y. Wang, “Theoretical and Experimental Study on Interactive Local Buckling of Arch-shaped Corrugated Steel Roof,” *Steel Struct.*, vol. 6, pp. 45–54, 2006.
- [15] R. Walentyński, R. Cybulski, and K. Kozieł, “Achilles’ heel of the ABM 120 double corrugated profiles,” in *Proc. 9th International Conference on New Trends in Statics and Dynamics of Buildings*, 2011.
- [16] A. Biegus and A. Kowal, “Katastrofa łukowej hali o konstrukcji z blach giętych na zimno,” in *Proc. XXV Konferencja Naukowo-Techniczna*, 2011, pp. 765–772 (in Polish).