



PIOTR CZUBAK*

**REDUCTION OF FORCES TRANSMITTED TO THE FOUNDATION BY THE CONVEYOR
OR FEEDER OPERATING ON THE BASIS OF THE FRAHM'S ELIMINATOR,
AT A SIGNIFICANT LOADING WITH FEED**

**REDUKCJA SIŁ PRZEKAZYWANYCH PRZEZ PRZENOŚNIK LUB PODAJNIK WIBRACYJNY
DZIAŁAJĄCY NA ZASADZIE ELIMINATORA FRAHM'A,
PRZY ZNACZNYM OBCIĘŻENIU NADAWĄ**

Conveyors operating on the basis of the Frahm's eliminator were compared to the classic constructions – in this study. The influence of the feed material mass on their operations was also investigated. The obtained results indicate the possibility of utilizing this type of conveyors for transporting feed material of a considerable mass, which is needed in the mining industry. The proper tuning of the excitation frequency of conveyors or feeders operating on the basis of the Frahm's eliminator was presented – in detail – in the paper, as well as the optimal values of the coefficient of throw were given.

The force transmitted by the conveyors and feeders of this type to the foundation is at its minimum when they are not loaded. When the load increases this force also increases. The author proved, by means of the numerical simulation, that by the proper selection of the excitation frequency, in dependence of the amount of the feed material, this force can be minimized. Thus, when the mass of the feed increases, the excitation frequency should be decreased according to the equation derived by the author in this paper.

Keywords: vibratory conveyor, resonance conveyor, vibratory feeder, resonance feeder, Frahm's eliminator conveyors, feed transport, minimization of transmitted forces

Przenośniki wibracyjne znajdują zastosowanie w przemyśle górniczym do transportu ciągłego materiałów sypkich na niewielkie odległości, zwykle nie dalej niż 20 m. Ze względu na specyfikę ruchu, największą wadą tego typu przenośników jest przenoszenie znaczących sił dynamicznych na podłoże. Dla obniżenia reakcji dynamicznych zaproponowano, już w latach sześćdziesiątych ubiegłego wieku, wykorzystanie efektu eliminatora dynamicznego Frahm'a w budowie przenośników wibracyjnych. Przewidywany rozwój tego typu przenośników rozpoczął się w początkiem XXI wieku.

W prezentowanej pracy porównano tego typu przenośniki z konstrukcjami klasycznymi, jak również zbadano wpływ masy nadawy na ich działanie. Wyniki uzyskane w niniejszej pracy pokazały możliwość wykorzystania tego typu rozwiązania do transportowania nadaw o znacznej masie, które występują w przemyśle górniczym. Przedstawiono sposób poprawnego strojenia częstości wymuszenia

* AGH UNIVERSITY OF SCIENCE AND TECHNOLOGY, FACULTY OF MECHANICAL ENGINEERING AND ROBOTICS,
A. MICKIEWICZA 30 AVE., 30-065 KRAKOW, POLAND

przenośników działających na zasadzie eliminatora Frahm'a, jak również podano optymalne wartości współczynnika podrzutu.

Minimalna siła przekazywana przez analizowany przenośnik na podłoże występuje wtedy, gdy nie ma na nim obciążenia a wzrasta wraz ze wzrostem masy transportowanej nadawy. Przy pomocy symulacji numerycznej autor wykazał, że przekazywaną siłę można zminimalizować przez odpowiedni dobór częstości wymuszenia – w zależności od ilości nadawy. Wraz ze wzrostem masy nadawy należy zmniejszać częstość wymuszenia minimalizując siłę przekazywaną na podłoże zgodnie z wyprowadzonym w pracy wzorem.

Słowa kluczowe: przenośnik wibracyjny, przenośnik rezonansowy, podajnik wibracyjny, podajnik rezonansowy, przenośnik – eliminator Frahm'a, transportowanie nadawy, minimalizacja sił przenoszonych

1. Introduction

Vibratory conveyors and feeders are applied in the mining industry for continuous transport of loose materials at rather small distances, up to 20 m (www.generalkinematics.com, www.jeffreyrader.com). Due to a specificity of their motion the most serious fault of this type of machines is transmitting significant dynamic forces on the foundation (Gozdziecki & Swiatkiewicz, 1975; Banaszewski, 1990; Blechman, 1994; Michalczyk & Czubak, 2006, 2010).

For decreasing dynamic reactions the utilization of the Frahm's dynamic eliminator (Frahm, 1906) in building vibratory conveyors and feeders, was proposed already in the sixtieth of the last century (Long & Tsuchiya, 1960). However, an intensive development of this type of machines started at the beginning of the 21st century. Nowadays many producers offer conveyors and feeders operating on this basis. They can be divided into two main groups. In the one type the exciting force is applied to the vibroinsulating frame and operates in the direction of vibrations (Hufford, 2001; Patterson, 2003; Jones et al., 2003; Gilman, 2000; Sleppy, 2002; Carmichael, 1982). In the other type the excitation force applied to the vibroinsulating frame does not operate in the direction of vibrations or is the rotating force (Long & Tsuchiya, 1960; Jones et al., 2003 – second part of the patent. www.vibra-schultheis.com. www.millpower.com). Also vertical conveyors operating on this basis are produced (www.vibra-schultheis.com).

However, so far, this type of solution is not applied in the mining industry where transported materials are of a significant weight, since it is generally believed that when the feed weight increases the forces transmitted to the foundation must also significantly increase.

It is shown, in the hereby paper, that at the proper selection of parameters of the conveyor or feeder operating on the basis of the Frahm's eliminator – despite of its heavy load – very low values of forces transmitted to the foundation can be achieved. These forces are even lower than in the case of vibratory conveyors and feeders placed on vibroinsulating frames. This feature is especially important when conveyors are situated in places very sensitive to vibrations (Michalczyk & Czubak, 2004).

Conveyors operating on the basis of the Frahm's eliminator are often erroneously called: natural frequency conveyors, while the frequency to which the conveyor is tuned is the partial frequency of the mass of the trough on its suspension and not the natural frequency of the whole conveyor system. The conveyor frame is excited for vibrations by a sinusoidal force $P_o \sin \omega t$, while the trough of the conveyor or feeder constitutes the mass damping the trough vibrations. The conveyor trough is connected with the frame by means of leaf springs of a coefficient of elasticity k_s satisfying the equation: $k_s = M_r \omega^2$ forming the Frahm's eliminator.

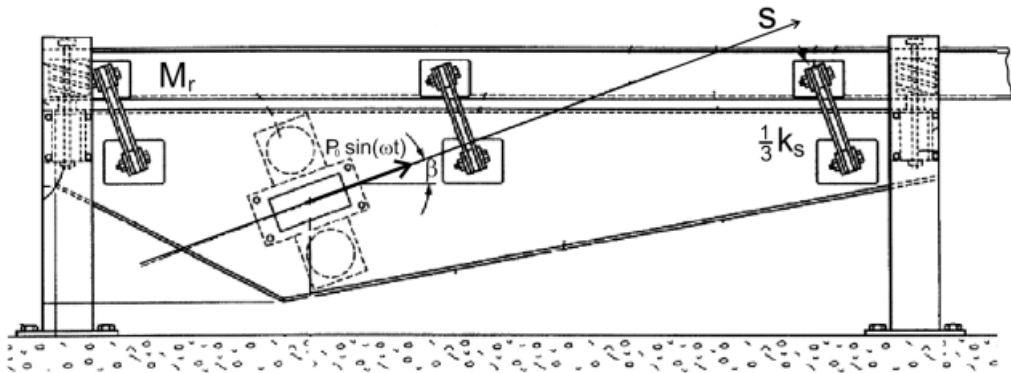

Fig. 1. Vibratory Conveyor. US. Pat 6,659,267 2003 FMC Technologies

The trough vibrates – in the steady state – with the amplitude triggering in the element k the counter-forces to the vibrator exciting force, which causes damping of the vibrations of the vibroinsulating frame. This means that, the frame is excited for vibrations by means of the force identical to the vibrator excitation force. There is a lack of studies assessing the effectiveness of this type of solution in the world scientific literature. This problem was discussed in some authors papers (Czubak & Michalczyk, 2006; Czubak, 2011).

Conveyors in which the exciting force operates in the direction of vibrations and passes via the frame and trough centre of gravity (which is mentioned as a significant feature in the majority of patents), are analysed in this paper. The exciting force of a linear character is usually obtained by producers, either by the kinematic forcing or by the system of two counter-running vibrators. The problem of vibrators self-synchronisation (Blechman, 1994), which can be disturbed by small vibrations of the frame, to which they are attached, as well as the problem of non-central direction of the exciting force (Michalczyk, 2012) are omitted in the study. The majority of producers are solving this problem by connecting vibrators by the mechanical transmission or the power selsyn system.

2. Mathematical model of conveyors on the basis of the dynamic eliminator operation

In order to determine forces transmitted to the foundations the schematic diagram, presented in Fig. 2, was analysed (Czubak, 2007).

The system shown in Fig. 2 has four degrees of freedom corresponding to coordinates: x , y , τ and β . At the assumption that $k_x = k_y$, and that the direction of the excitation force passes via the centre of gravity as well as via the centre of the suspension system the conveyor system can be reduced to the one presented in Fig. 3, where x_1 and x_2 are absolute coordinates.

Assuming the mono-harmonic forcing in a form: $P_0(t) = me\omega^2 \sin(\omega t)$ and limiting the considerations to the steady state only, the differential equations system for the scheme presented in Fig. 3 can be written as follows:

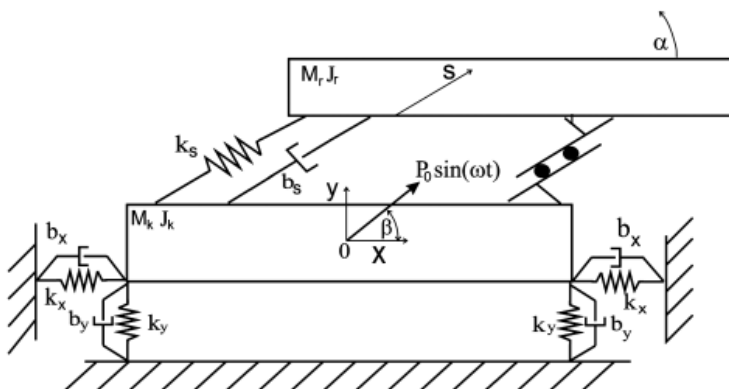

Fig. 2. Diagram of the vibratory conveyor

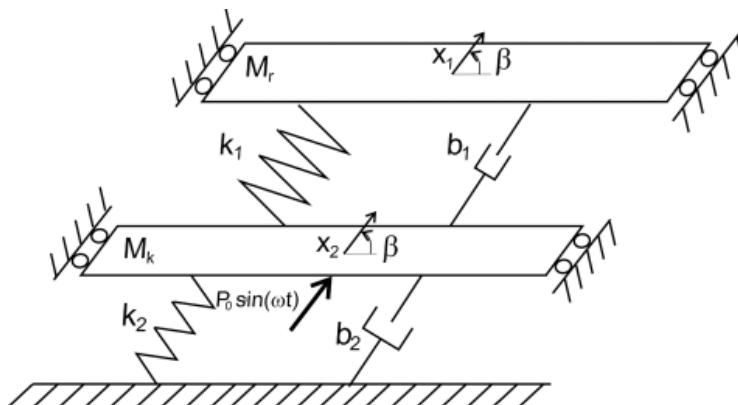

Fig. 3. Simplified diagram of the vibratory conveyor

$$\begin{aligned}
 -M_r \omega^2 \underline{X}_1 + b_1 i \omega (\underline{X}_1 - \underline{X}_2) + k_1 (\underline{X}_1 - \underline{X}_2) &= 0 \\
 -M_k \omega^2 \underline{X}_2 + b_1 i \omega (\underline{X}_2 - \underline{X}_1) + b_2 i \omega \underline{X}_2 + k_1 (\underline{X}_2 - \underline{X}_1) + k_2 \underline{X}_2 &= m e \omega^2
 \end{aligned}
 \tag{1}$$

where:

- \underline{X}_1 — complex amplitude of the harmonic motion along coordinate x_1 ,
- \underline{X}_2 — complex amplitude of the harmonic motion along coordinate x_2 ,
- ω — excitation frequency $F(t)$,
- m — sum of unbalanced vibrator masses,
- e — eccentric of mass m ,
- i — imaginary unit,
- M_r — mass of the conveyor trough,
- M_k — mass of the conveyor frame,

- k_1 — coefficients of elasticity of the support system of the vibroinsulating trough,
 k_2 — coefficients of elasticity of the support system of the vibroinsulating frame,
 b_1 — coefficients of damping of the support system of the vibroinsulating trough,
 b_2 — coefficients of damping of the support system of the vibroinsulating frame.

Coefficient of damping was determined from the dependence:

$$b_i = \frac{\psi_i k_i}{2\pi\omega}$$

while the dissipation coefficient was assumed as: $\psi_1 = 0.09$, $\psi_2 = 0.14$

After solving these equations for unknowns S_1 and S_2 , the complex amplitude value is obtained:

$$\begin{aligned} \underline{X}_1 &= \frac{-m\omega^2(-b_1^2\omega^2 + k_1^2 + 2ik_1b_1)}{\left(\begin{aligned} &(m_1m_2\omega^4 - m_1\omega^2(k_1 + k_2) - m_2\omega^2k_1 + k_1k_2 - b_1b_2\omega^2) + \\ &-i \cdot (m_1\omega^3(b_1 + b_2) - k_1b_2\omega + m_2\omega^3b_1 - b_1k_2\omega) \end{aligned} \right) (k_1 + ib_1\omega)} \\ \underline{X}_2 &= \frac{m\omega^2(-m_1\omega^2 + k_1 + ib_1\omega)}{\left(\begin{aligned} &(m_1m_2\omega^4 - m_1\omega^2(k_1 + k_2) - m_2\omega^2k_1 + k_1k_2 - b_1b_2\omega^2) + \\ &-i \cdot (m_1\omega^3(b_1 + b_2) - k_1b_2\omega + m_2\omega^3b_1 - b_1k_2\omega) \end{aligned} \right)} \end{aligned} \quad (2)$$

Modules of the complex amplitudes values determine the real amplitude values, while:

$$F = \left| \underline{X}_2 \right| \cdot \sqrt{k_2^2 + b_2^2\omega^2} \quad (2a)$$

constitutes the amplitude of the force transmitted to the foundation. The analytical solution of equations of motion provides the possibility of analysing the motion properties of the conveyor in dependence of the excitation force frequency ω .

3. Determination of forces transmitted to the foundations by the conveyor without a feed material.

In order to determine more precisely advantages and faults of the discussed solution, the curves presenting the forces transmitted to the foundations by different types of conveyors – but of the same parameters – are included in Fig. 4.

Curve 1 (Fig. 4) presents the force transmitted to the foundation, by the vibratory conveyor operating on the basis of the Frahm's eliminator, in the excitation frequency function. The mass of the conveyor trough was 3700 [kg], the excitation force amplitude $P_0 = 90$ [kN], and the through vibration amplitude 2.4 [mm], at the rated frequency $\omega = 106$ [rad/s]. The mass of the frame, to which the excitation force was applied, was 2600 [kg]. The coefficient of elasticity of

the leaf spring suspension of the trough, in the conveyor operating on the bases of the Frahm's eliminator, depended on the mass of the trough and on the excitation force frequency ω – in such a way as to fulfill the condition: $k_1 = m_1\omega^2 = 42171481$ [N/m]. Whereas the coefficient of elasticity of the frame suspension of this conveyor was selected to obtain the static deflection – caused by the feed mass in the conveyor vertical direction - the same as in the case of the classically vibroinsulated conveyor.

Curve 2 corresponds to the force transmitted by a classic vibroinsulated conveyor, with the excitation force applied to the trough, placed on the leaf springs system which stiffness coefficient was $k_1 = 1531750$ [N/m] and vibroinsulated by the frame of a mass 2600 [kg] (this is the mass sufficient to obtain a significant decrease of forces transmitted to the foundation in this type of solution (Czubak, 2006)). The stiffness coefficient of the vibroinsulating mass suspension, in the vibroinsulated conveyor, was determined by the equation: $k_2 = k_1(m_2 + m_1)/m_1$.

Curve 3 corresponds to the classic, not vibroinsulated, conveyor placed on the leaf springs system of the stiffness coefficient $k_1 = 1531750$ [N/m].

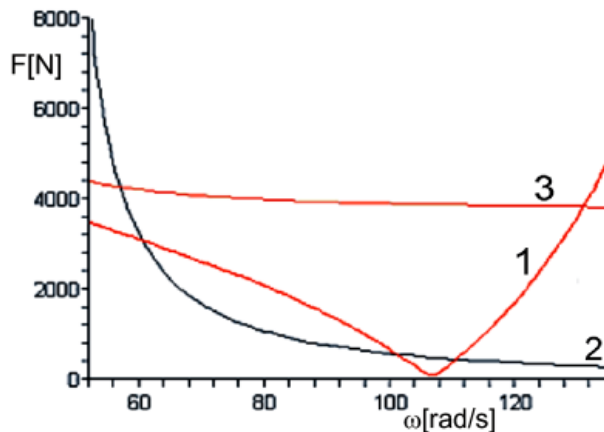

Fig. 4. Dependence of the forces transmitted to the foundation as a function of the excitation frequency.

1 – Conveyor operating on the basis of the Frahm's eliminator – drawn from equations 2 and 2a.

2 – Vibroinsulated conveyor placed on leaf springs (Czubak, 2007).

3 – Conveyor placed on leaf springs without vibroinsulation (Czubak, 2007)

In the steady state, at the working excitation frequency $\omega = 106$ [rad/s], the force transmitted by the vibratory conveyor operating on the basis of the Frahm's eliminator without a feed material is 48 times lower than the force transmitted by not vibroinsulated conveyor and 6 times lower than the force transmitted by the conveyor vibroinsulated by a massive frame with the excitation force applied to the trough. The conveyor operating on the basis of the Frahm's eliminator provides very small reaction forces in the steady state, provided that damping in the system of leaf springs is relatively small. In this type of conveyors forces transmitted to the foundations significantly increase in case of offsetting from the working frequency, e.g. due to offsetting of the spring system k_1 , or changes in the slip of motor related to power voltage changes or due to significant changes in the feed material load.

4. Model of the analysed conveyor loaded with a feed material

On account of a strong dependence of the eliminator effectiveness on damping in the system, analysis performed without taking into consideration the feed are usually burdened by a large error since the basic damping occurs in the feed (Rouijaa et al., 2005; Guillermo & Martinez, 2001; Sloot & Kruyt, 1996; Cleary & Sawley, 1999; Michalczyk, 2008; Banaszewski, 1990).

To be able to assess the feed influence on the effectiveness in the reduction of forces transmitted to foundations by the conveyor – of the analysed type – the simulation model, corresponding to the scheme shown in Fig. 5, was developed.

Simplifying assumptions adopted in the given above analysis indicate a usefulness of the verification of the obtained equations by means of the computer simulation of the system motion.

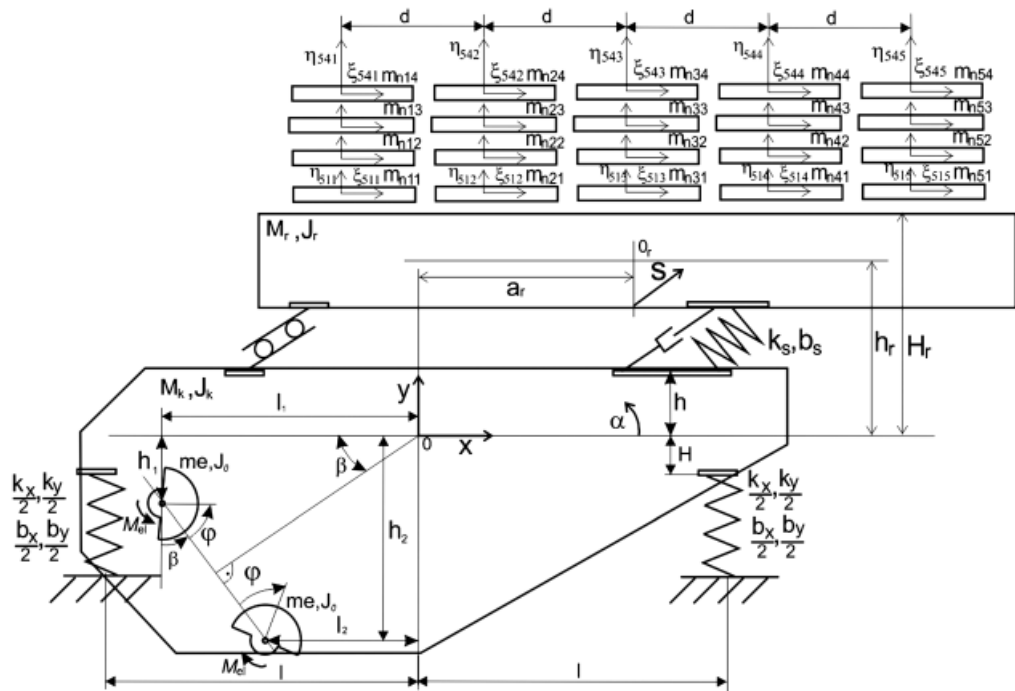

Fig. 5. Model of the feeder together with a feed material

The model consists of: two inertial vibrators excited by the motor described by a static characteristics, the machine body performing a plane motion and supported by a system of vertical coil springs and five four-layer models of the loose feed material, (Michalczyk & Cieplok, 2006; Michalczyk & Czubak, 2010) arranged in different points of the machine working surface. Influence of the gravity force on the angular motion of vibrators is taken into account in this model.

The mathematical model of such system consists of the matrix equation (3) describing the machine motion, equations (10) concerning electromagnetic moments of driving motors, equa-

tions (9) determining motions of successive layers of a feed material as well as equations (7) and (8) describing normal and tangent influences in between the feed material layers and between the feed material and the machine body.

$$M \cdot \ddot{q} = Q \quad (3)$$

where:

$$M = \begin{bmatrix} M_k + m + m + M_r & 0 & m(h_1 + h_2) - M_r h_r & 2me \cos \beta \cdot \cos \varphi & M_r \cos \beta \\ 0 & M_k + m + m + M_r & -m(a_1 + a_2) + M_r a_r & 2me \sin \beta \cdot \cos \varphi & M_r \sin \beta \\ m(h_1 + h_2) - M_r h_r & -m(a_1 + a_2) + M_r a_r & m(h_2^2 + l_2^2 + h_1^2 + l_1^2) + M_r(h_r^2 + a_r^2) + J_k + J_r & me(h_1 \cos(\beta + \varphi) - a_1 \sin(\beta) + \varphi + h_2 \cos(\varphi) - \beta + l_2 \sin(\varphi) - \beta) & M_r(a_1 \sin \beta - h_1 \cos \beta) \\ 2me \cos \beta \cdot \cos \varphi & 2me \sin \beta \cdot \cos \varphi & me(h_1 \cos(\beta + \varphi) - a_1 \sin(\beta) + \varphi + h_2 \cos(\varphi) - \beta + l_2 \sin(\varphi) - \beta) & 2me^2 + 2J_0 & 0 \\ M_r \cos \beta & M_r \sin \beta & M_r(a_1 \sin \beta - h_1 \cos \beta) & 0 & M_r \end{bmatrix} \quad (4)$$

$$\ddot{q} = [\ddot{x} \ \ddot{y} \ \ddot{\alpha} \ \ddot{\varphi} \ \ddot{s}]^T \quad (5)$$

$$Q = \begin{bmatrix} -2me\dot{\varphi}^2 \sin \varphi \cdot \cos \beta - k_x(x + H\alpha) - b_x(\dot{x} + H\dot{\alpha}) - T_{101} - T_{102} - T_{103} - T_{104} - T_{105} \\ me\dot{\varphi}^2(\sin(\varphi - \beta) + \cos(\beta + \varphi)) - \frac{1}{2}k_y(y + l_1\alpha) - \frac{1}{2}k_y(y - l_2\alpha) \\ - \frac{1}{2}b_y(\dot{y} + l_1\dot{\alpha}) - \frac{1}{2}b_y(\dot{y} - l_2\dot{\alpha}) - F_{101} - F_{102} - F_{103} - F_{104} - F_{105} \\ - me\dot{\varphi}^2(h_1 \sin(\beta + \varphi) + l_1 \cos(\beta + \varphi)) + m_2 e_2 \dot{\varphi}^2(-h_2 \sin(\varphi - \beta) \\ + l_2 \cos(\varphi - \beta)) - k_x H^2 \alpha - k_x H \dot{x} - b_x H \dot{x} - b_x H^2 \dot{\alpha} - \\ \frac{1}{2}k_y(y + l\alpha)l + \frac{1}{2}k_y(y - l\alpha)l - \frac{1}{2}b_y(\dot{y} + l\dot{\alpha})l + \frac{1}{2}b_y(\dot{y} - l\dot{\alpha})l \\ + (T_{101} + T_{102} + T_{103} + T_{104} + T_{105})H_r + F_{101}(2d - a_r) + F_{102}(d - a_r) \\ - F_{103}a_r - F_{104}(d + a_r) - F_{105}(2d + a_r) \\ 2M_{ef} - 2b_s \dot{\varphi}^2 \text{sign}(\dot{\varphi}) - mge(\sin(\beta + \varphi) + \cos(\varphi - \beta)) \\ k_s s - (T_{101} + T_{102} + T_{103} + T_{104} + T_{105})\cos \beta - (F_{101} + F_{102} + F_{103} + F_{104} + F_{105})\sin \beta \end{bmatrix} \quad (6)$$

where:

- s — is a relative coordinate,
- $F_{j,j-1,k}$ — normal component of the j^{th} layer pressure on $j-1$ layer – in the k^{th} column,
- $T_{j,j-1,k}$ — tangent component of the j^{th} layer pressure on $j-1$ layer – in the k^{th} column,
- j — feed material index, $j=0$ concerns the machine body,
- k — feed material column index.

If successive layers of the feed material j and $j-1$ (in the given column) are not in contact, the contact force in the normal direction $F_{j,j-1,k}$ and in the tangent direction $T_{j,j-1,k}$ between these layers equals zero:

$$F_{j,j-1,k} = 0, \quad T_{j,j-1,k} = 0 \quad \text{for} \quad \eta_{j,k} \geq \eta_{j-1,k}$$

Otherwise, the contact force in the normal direction between layers j,k and $j-1,k$ of the feed material occurs (or in the case of the first layer: between the layer and the body), which model is of the form:

$$F_{j,j-1,k} = (\eta_{j-1,k} - \eta_{j,k})^p \cdot k_H \cdot \left\{ 1 - \frac{1-R^2}{2} \left[1 - \text{sgn}(\eta_{j-1,k} - \eta_{j,k}) \cdot \text{sgn}(\dot{\eta}_{j-1,k} - \dot{\eta}_{j,k}) \right] \right\} \quad (7)$$

and the force originated from friction in the tangent direction:

$$T_{j,j-1,k} = -\mu F_{j,j-1,k} \text{sgn}(\dot{\xi}_{j,k} - \dot{\xi}_{j-1,k}) \quad (8)$$

where:

- R — restitution coefficient of normal impulses at collision,
- k_H, p — Hertz-Stajerman constants.

The form of dependence (7) was developed in the paper (Michalczyk, 2008) on the basis of the Hertz-Stajerman contact forces model modified by taking into account a material damping.

Parameters of the hysteresis loop were assumed in such a way as to have the ratio – of the bodies relative velocity after the collision to their velocity before the collision – equal R . It means formula (7) ensures that this ratio is equal to the assumed restitution coefficient value.

Equations of motion of individual layers in directions ζ and η , with taking into consideration the influence of the conveyor on the lower layers of a feed material, are in the following form:

$$\begin{aligned} m_{nj,k} \ddot{\xi} &= T_{j,j-1,k} - T_{j+1,j,k} \\ m_{nj,k} \ddot{\eta} &= -m_{nj,k} g + F_{j,j-1,k} - F_{j+1,j,k} \end{aligned} \quad (9)$$

M_{el} – electromagnetic moment generated by the i^{th} motor, assumed in the form corresponding to the static characteristic of the motor:

$$\mathcal{M}_{el} = \frac{2\mathcal{M}_{ut}(\omega_{ss} - \dot{\varphi}) \cdot (\omega_{ss} - \omega_{ut})}{(\omega_{ss} - \omega_{ut})^2 + (\omega_{ss} - \dot{\varphi})^2} \quad (10)$$

where:

- M_{ut} — stalling torque of driving motors,
- ω_{ss} — synchronous frequency of driving motors,
- ω_{ut} — stalling frequency of driving motors.

The simulation was performed for the following parameter values:

- l = 4 [m]
- l_1 = 1.54 [m] (variable)
- l_2 = 1.05 [m] (variable)
- h_1 = 0.31 [m] (variable)
- h_2 = 1.18 [m] (variable)
- H = 0.0 [m]
- h = 0.0 [m]
- h_r = 0.0 [m]
- H_r = 0.0 [m]
- a_r = 0.0 [m]
- d = 0.8 [m]
- β = 30^0 (variable)
- k_x = k_y = 2328000 [N/m]
- k_s = 42171481 [N/m]
- b_x = $b_y = \frac{\psi_{x,y} k_{x,y}}{2\pi\phi}$ [Ns/m]
- $b_s = \frac{\psi_s k_s}{2\pi\phi}$ [Ns/m]
- $\psi_{x,y}$ = 0.14
- ψ_s = 0.9
- m = 15 [kg]
- J_0 = 0
- e = variable (K)[m]
- K = coefficients of throw
- M_r = 3700 [kg]
- M_k = 2600 [kg]
- $\sum m_n$ = variable
- J_k = 500 [kgm²]
- J_r = 700 [kgm²]
- M_{ut} = 50 [Nm]
- ω_{ss} = 106 [rad/s] (variable)
- ω_{ut} = $15.9 * 2\pi$ [rad/s] (variable)
- b_s = 0.0 [Nms²]
- R = 0.13
- μ = 0.4

The simulation model developed for the verification of analytical solutions takes into consideration not only factors included in these solutions but also other phenomena of an essential meaning for the process.

5. Determination of forces transmitted to the foundations, with taking into account the feed material influence

The conveyor was simulated at several inclination angles $\beta = 90^\circ, 60^\circ, 45^\circ, 30^\circ, 20^\circ$, as well as at various coefficients of throw K and feed material masses. The analysed value was the force transmitted to the foundation. Figures 6 and 7 presented below are given as examples, on which bases the conclusions concerning the tuning of conveyors, operating on the basis of the Frahm's eliminator and loaded with the massive feed material, were made.

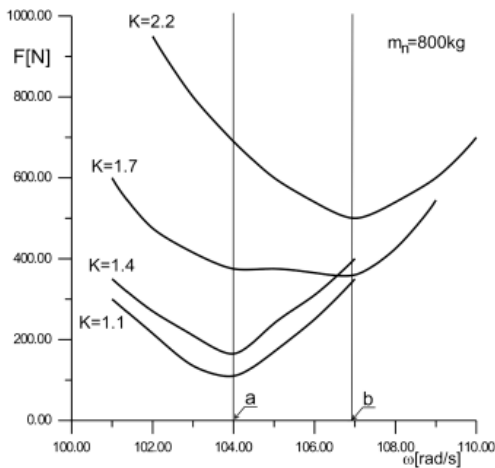

Fig. 6. Forces transmitted to the foundation in dependence of the excitation frequency for the mass of the feed: $m_n = 800$ [kg], at various coefficients of throw

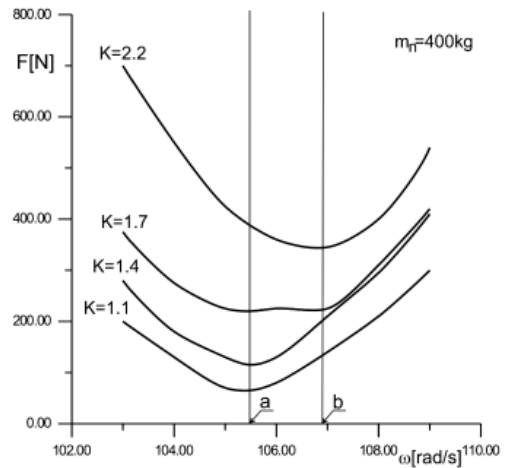

Fig. 7. Forces transmitted to the foundation in dependence of the excitation frequency for the mass of the feed: $m_n = 400$ [kg], at various coefficients of throw

In Figures 6 and 7:

- a* — excitation frequencies when the feed is taken into account (the value determined by equation 11),
- b* — excitation frequencies when the feed is not taken into account (the value determined by equation: $\omega = \sqrt{k_s/M_r}$).

Figures 6 and 7 present forces transmitted to the foundations in dependence of the excitation frequency for two masses of feed materials (800 and 400 [kg]) at various coefficients of throw for the most typical variant of the conveyor with the angle: $\beta = 30^\circ$. This is the angle, at which the feed material is transported at the highest velocity (Banaszewski, 1990; Blechman, 1994; Czubak, 1964). These diagrams were formed by the approximation of points determined every time in the steady state at the given frequency and mass of the feed.

After analysing the performed simulations several conclusions can be drawn.

When the mass of the feed constitutes **less than 5%** of the mass of the trough (which should be relatively heavy (Czubak, 2007)) the conveyor should be tuned without taking into account the mass of the feed. When the mass of the feed is above 5% of the mass of the trough the conveyor should be tuned with taking into account the mass of the feed – in dependence of the coefficient of throw value. Figure 8 presents approximate phase of the feed landing in dependence of the coefficient of throw.

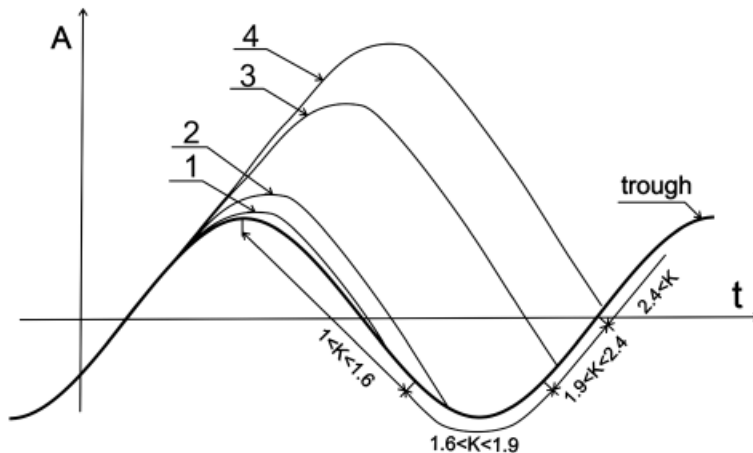

Fig. 8. Phase of the feed impact in dependence of the coefficient of throw

- 1) When the coefficient K for the conveyor is within the range:
 $1 \leq K \leq 1.6$ – the conveyor **should be tuned** taking into account the influence of the mass of the feed on the excitation frequency – in accordance with the empirically determined equation:

$$\omega = \sqrt{\frac{k_s}{M_r + m_n \sin^2 \beta}} \quad (11)$$

where:

- M_r — mass of the conveyor trough,
- k_s — cumulative coefficient of stiffness of leaf springs in the working direction s ,
- m_n — mass of the feed material,
- β — inclination angle of the trough vibration direction from the level.

This is in accordance with the equation (Michalczyk & Cieplak, 1999) for the influence of the mass of the feed on the coefficient of throw in the case when the vibratory machine is placed directly on the foundation and loaded with the feed material. In this case the velocity difference during collision of the feed with the trough is quite small and thus, it can be stated that the feed ‘cooperates’ with the trough. This means that to cause the trough with the feed, operating as the

Frahm's eliminator, the part of the feed mass – which influences the system vibrations in the working direction – should be added to the mass of the trough.

2) When the coefficient K is within the range:

$1.6 \leq K \leq 1.9$ – the conveyor can be tuned in a wide range between the frequency resulting from taking into account the mass of the feed and the one resulting directly from equations not taking into account the influence of the feed on the excitation frequency:

$$\sqrt{\frac{k_s}{M_r + m_n \sin^2 \beta}} \leq \omega \leq \sqrt{\frac{k_s}{M_r}} \quad (12)$$

In this case the minimum of forces transmitted to the foundation occurs in a wide range of excitation frequencies. However, the value of this **force is higher** than in the case of tuning for: $1 \leq K \leq 1.6$.

3) When the coefficient K is within the range:

$1.9 \leq K \leq 2.4$ – the conveyor should be tuned for the excitation frequency, according to equation:

$$\omega = \sqrt{\frac{k_s}{M_r}} \quad (13)$$

In this case tuning does not depend on the mass of the feed. The forces transmitted to the foundation are **much higher** than in the previous cases. The feed 'does not cooperate' with the trough and the difference in the collision velocity between the feed and the trough is significant, which causes also the damping increase in the system. The large damping in the conveyor trough system causes that forces transmitted to the foundations significantly increase (the Frahm's eliminator is not properly operating due to a high damping).

4) $2.4 \leq K$ – the conveyor **will not operate properly** when the mass of the feed is above 5% of the mass of the trough. Forces transmitted to the foundation are much higher than in other cases. This is the result of a chaotic feed movement on the trough (Fig. 9), in spite of the fact that for $K < 3.3$ it is still mono-harmonic. Velocities of feed collisions with the trough are not the same at successive collisions and occurs at various time spacing, which causes the total detuning of the system.

It should be mentioned that at decreasing the coefficient of throw as well as the excitation frequency the transport velocity decreases (Rademacher & oth, 1994; Banaszewski, 1990; Czuba, 1964). As can be seen in Fig. 10 the transport velocity is not much different within the given excitation frequency, while the change of the coefficient of throw has a significant influence.

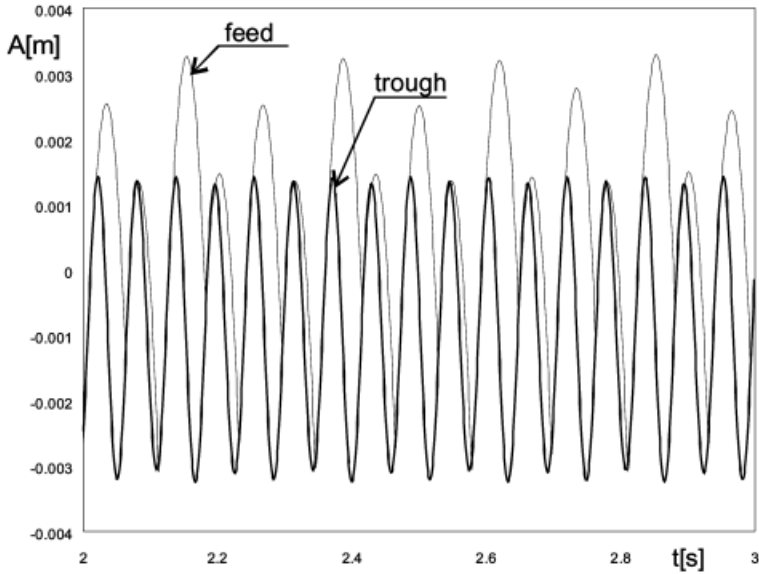

Fig. 9. Displacement of the trough and feed in the vertical direction for the coefficient of throw: $K > 2.4$, $m_n = 800$ [kg]

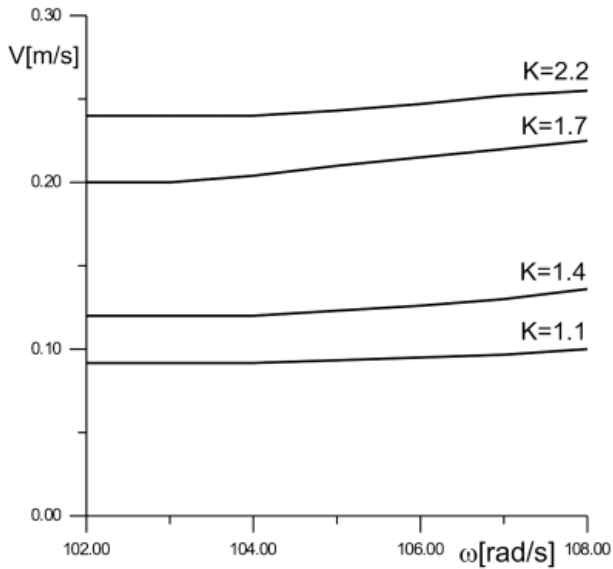

Fig. 10. Transport velocity in dependence of the excitation frequency for various coefficients of throw K , $m_n = 800$ [kg]

6. Conclusions

1. Out of the investigated vibratory conveyors of similar parameters, the force transmitted to the foundation by the conveyor operating on the basis of the Frahm's eliminator without a significant load of feed material is – in the steady state – 48 times lower than the force transmitted by not vibroinsulated conveyor and 6 times lower than the one transmitted by the vibroinsulated conveyor with the excitation force applied to the trough.
2. The author proposed using the dependence No. 11 for the determination of the excitation frequency of the conveyor loaded with the feed material of a significant mass, when the coefficient of throw: $K < 1.6$.
3. Operating at the coefficient of throw $K > 2.1$ is disadvantageous for the investigated type of conveyors, due to a significant increase of forces transmitted to the foundation.
4. In the case, when the conveyor is loaded with the feed of a variable or unknown mass the good results can be obtained by retuning the excitation frequency in such a way as to have the system operating in the F_{\min} range of the force transmitted to the foundation.
5. Changes of the excitation frequency in the vicinity of the working point, have only negligible influence on the transport velocity, while changes of the coefficient of throw have a significant influence on this operation.

References

- Banaszewski T., 1990. *Przesiewacze*. Katowice.
- Blechman I.I., 1994. *Vibration Mechanic*. Moscow, Fizmatlit.
- Carmichael D., 1982. *Excited Frame, Vibratory Conveying Apparatus for Moving Particulate Material*. US. pat 4,313,535.
- Cleary P.W., Sawley M.L., 1999. *Three-dimensional modelling of industrial granular flows*. Second International Conference on CFD in the Minerals and Process Industries CSIRO Melbourne, Australia.
- Czubak A., 1964. *Vibratory Conveyors*. Slask, Katowice.
- Czubak P., 2006. *Mass Optimisation of the Vibroinsulating Frame of a Short Vibratory Conveyor*. Mechanics, Vol. 25 No. 1.
- Czubak P., 2007. *Analysis of a vibratory conveyor operating on the basis of the Frahm's eliminator of vibrations*. Machine Dynamics Problems, Vol. 31, No. 4, p. 34-45.
- Czubak P., 2011. *Equalization of the Transport Velocity in a New Two-Way Vibratory Conveyor*. Archives of Civil and Mechanical Engineering, Vol. XI, pages 573-586.
- Czubak P., Michalczyk J., 2007. *Mobile properties of vibratory conveyors operating on the basis of the dynamic eliminator*. Modelowanie Inzynierskie, Vol. 2, No. 33.
- Frahm H., 1909. *Device for Damping Vibrations of Bodies*. US Patent No. 989958.
- Gilman D., 2000. *Vibratory Conveyor*. US pat. 6,079,550.
- Gozdziecki M., Swiatkiewicz H., 1975. *Conveyors*. WNT Warszawa.
- Guillermo Rein Soto-Yarritu, Martinez A.A., 2001. *Computer Simulation of Granular Material: Vibrating Feeders*. Powder Handling & Processing, Vol. 13, No 2.
- Hufford D., 2001. *Vibratory Conveyor*. US pat 6,286.658.
- Jones P., Ruff J., Gale J., 2003. *Excited Frame Conveyor and Excitation Process for Same*. US pat 6,655,523.
- Kruelle C.A., Rouijaa M., Gotzendorfer A., Rehberg I., Grochowski R., Walzel P., Elhor H., Linz S.J., 2004. *Reversal of Granular Flow on a Vibratory Conveyor*. 2005, Applied Phys. Lett. 84: 1019-1021.

- Long G., Tsuchiya T., 1960. *Vibratory Conveyors*. US pat 2,951,581.
- Martin L., 2000. *Spring Connection for Vibratory Conveyor*. US pat 6,161,680.
- Michalczyk J., 2008. *Phenomenon of Force Impulse Restitution in Collision Modelling*. Journal of Theoretical and Applied Mechanics, No. 4, Vol. 46, 2008.
- Michalczyk J., 2012. *Angular Oscillations of Vibratory Machines of Independent Driving Systems Caused by a Non-Central Direction of the Exciting Force Operations*. Archives of Mining Sciences, Vol. 57 No 1.
- Michalczyk J., Cieplok G., 2006. *Numerical Model of Vibrating Screen*. Modelowanie Inżynierskie, Vol. 1, No 32.
- Michalczyk J., Cieplok G., 1999. *Analysis of the Trough Vibration of Vibratory Machine with the Disturbances Excited by Collision with the Material Feed*, Mechanika t. 18 zeszyt 2.
- Michalczyk J., Czubak P., 2004. *Analysis of Forces Transmitted to the Foundation by Hydroextractors*. Archives of Mining Sciences, Vol. 49, iss. 3.
- Michalczyk J., Czubak P., 2006. *Natural vibrations of long vibratory conveyors*. Archives of Metallurgy and Materials, Vol. 51, No. 1.
- Michalczyk J., Czubak P., 2010. *Influence of Collisions with a Feed Material on Cophasal Mutual Synchronisation of Driving Vibrators of Vibratory Machines*. Journal of Theoretical and Applied Mechanics, Vol. 48, No. 1.
- Michalczyk J., Czubak P., 2010. *Methods of Determination of Maximum Amplitudes in the Transient Resonance of Vibratory Machines*. Archives of Metallurgy and Materials, Vol. 55, No. 3.
- Patterson H., 2003. *Two-Mass, Base-Excited Conveyor*. US pat 6,659,267.
- Rademacher F.J.C., Ter Borg L., 1994. *On the Theoretical and Experimental Conveying Speed of Granular Solids on Vibratory Conveyors*, Eng. Res. 60: 261-283.
- Rouijaa M., Kruelle C.A., Rehberg I., Grochowski R., Walzel P., 2005. *Transport and Pattern Formation in Granular Materials on a Vibratory Conveyor*. Chem. Eng. Technology 28: 41-44.
- Sleppy P., 2002. *Excited Base Conveyor System*. US pat. 6,415,913.
- Sloot E.M., Kruyt N.P., 1996. *Theoretical and Experimental Study of the Transport of Granular Materials by Inclined Vibratory Conveyors*. Powder Technology 87: 203-210.
- www.vibra-schultheis.com
- www.millpower.com
- www.generalkinematics.com
- www.jeffreyrader.com

Received: 06 February 2012