

Acoustical Analysis of Enclosure as Initial Approach to Vehicle Induced Noise Analysis Comparately Using STFT and Wavelets

Andrzej BŁAŻEJEWSKI⁽¹⁾, Piotr KOZIOŁ⁽²⁾, Maciej ŁUCZAK⁽²⁾

⁽¹⁾ *Institute of Technology and Education, Koszalin University of Technology*
Śniadeckich 2, 75-453 Koszalin, Poland; e-mail: andrzej.blazejewski@tu.koszalin.pl

⁽²⁾ *Department of Civil and Environmental Engineering, Koszalin University of Technology*
Śniadeckich 2, 75-453 Koszalin, Poland

(received April 10, 2014; accepted July 2, 2014)

It is assumed in the paper that the signals in the enclosure in a transient period are similar to a noise induced by vehicles, tracks, cars, etc. passing by. The components of such signals usually points out specific dynamic processes running during the observation or measurements. In order to choose the best method of analysis of these phenomena, an acoustic field in a closed space with a sound source inside is created. Acoustic modes of this space influence the sound field. Analytically, the modal analyses describe the above mentioned phenomena. The experimental measurements were conducted in the room that might comprise the closed space with known boundary conditions and the sound source Brüel & Kjær Omni-directional type 4292 inside. To record sound signals before the field's steady state was reached, the microphone type 4349 and the 4-channel frontend 3590 had been used. The obtained signals have been analysed by using two approaches, i.e. Fourier and the wavelet analysis, with the emphasis on their efficiency and the capability to recognise important details of the signal. The results obtained for the enclosure might lead to the formulation of a methodology for an extended investigation of a rail track or vehicles dynamics.

Keywords: modal analysis, short-time Fourier transform, wavelet transform, acoustic signal processing.

Notations

f – source outflow [m³/s],
 c – speed of sound in air [m/s],
 Z_i – acoustic impedance on the surface i [Pa·s/m],
 $r(x, y, z)$ – arbitrary point inside the enclosure described by coordinates x, y, z ,
 $p = p(r, t)$ – acoustic pressure at a point $r(x, y, z)$ [Pa],
 Δ – Laplasian, differential operator ∇^2 ,
 S – area of a boundary [m²],
 V – volume of the enclosure [m³],
 $T_m(t)$ – modal time m -component,
 $\Psi_m(r)$ – m -eigenfunction,
 λ_m – m -eigenvalue [1/m²],
 ω_m – m -eigenfrequency [Hz],
 α_m – coefficient describing damping (related to impedance Z) of each time component T_m ,
 β_m – m -eigen frequency for acoustic system with damping,
 f_G – Gaussian pulse mean frequency [Hz],
 σ – Gaussian pulse frequency dispersion [s],
 ξ – relaxation time [s],

η – shear viscosity coefficient (dynamic viscosity) [Pa·s],
 η_B – bulk (volume) viscosity coefficient [Pa·s],
 κ – thermal conductivity coefficient [W/m·K],
 C_p – heat capacity at constant pressure [J/kg·K],
 C_v – heat capacity at constant volume [J/kg·K].

1. Introduction – acoustical analysis

An acoustic field in an enclosure is a specialcase of acoustic wave propagation. After the sound source has generated a signal, a sound wave propagates inside a room. A loss of acoustic energy caused by absorption is specified by the impedance appears at boundaries. This attenuation is equalized in the short term by the energy from the source. If the source is active, after this transient period, the steady state behaviour dominates in the enclosure. Here, the transient period is considered as the dynamical behaviour of the acoustic system. In order to describe the acoustic field distribution inside a room, one can use modal analysis formulation under several restrictions (MORSE, INGARD, 1968).

The first factor in a modal approach states that the enclosure can be considered as a resonator, and an acoustic field distribution inside is dependent on its normal modes (eigenfunctions). It is assumed that one can use the eigenfunctions in the case of a room with perfectly rigid walls, i.e. Neuman's boundary condition equals to zero. Simultaneously, orthogonality and normalization of eigenfunctions are required (MEISSNER, 2008). The second factor indicates that the time components describe acoustic pressure variation in time, i.e. an increasing sound when a source starts and a decreasing sound when a source becomes mute. On the other hand, the acoustic field inside the room with a source is described by a linear inhomogeneous wave equation and the specific boundary conditions most often are determined by the wall's acoustic impedance. In this paper, a modal approach is considered to be the way to find the solution of the problem and emphasises specific features of the solution. In this case, the general solution is the sum of the products of two components. One of them is an eigenfunction and the other is a time component. The time components are closely related to certain eigenfrequencies and the enclosure absorption properties. Thus, the signal that propagates in the enclosure should have a discrete frequency spectrum in the range where eigenfrequencies are separated adequately. The most important advantages come from the fact that the variability of the signal received in the enclosure is predictable in the frequency and time domain. The experimental design and theoretical feedback subsequently give a possibility to test different approaches to analysis of the signals which are characteristic for dynamical behaviour of objects and systems.

Here, the enclosure is treated as "the filter" with capability to shape the acoustic signals in a specific way in the frequency and time domain. The filter input is the source of sound which generates the Gaussian impulse. This kind of signal in the low frequency range guarantees that sparsely distributed acoustic modes of the enclosure are excited. Additionally, the impulse creates the transient signal in the enclosure that can be considered as produced by a source which moves and drifts away from a point where it is observed or measured. Therefore, in this paper the acoustical analysis of the enclosure with the special excitation can be applied as the initial approach to the vibro-acoustical analysis of the dynamic system analysis, e.g. analysis of the signals usually generated by means of transport.

1.1. Theoretical background – the modal approach to acoustic field description

1.1.1. Linear elastic

What should be considered, it is the acoustic field inside an arbitrary enclosure V with a vibro-acoustical source which is located in a determinate area (points)

and characterised by its power or outflow f . The field is described by the well-known wave equation (MORSE, BOLT, 1994):

$$\Delta p - \frac{1}{c^2} \frac{\partial^2 p}{\partial t^2} = f, \quad (1)$$

where c is the sound velocity in air and differential operator $\Delta = \nabla^2$. The Neumann's impedance boundary conditions on each part i of the boundary, characterized by the area S of the limited enclosure and by the volume V , are in the form:

$$\frac{\partial p}{\partial n} = -\rho_0 \frac{1}{Z_i} \frac{\partial p}{\partial t}, \quad (2)$$

where Z_i is the impedance on the surface i and ρ_0 is the air density. In Eqs. (1) and (2) the function $p = p(r, t)$ represents the values of the acoustic pressure at the point $r(x, y, z)$ of the enclosure in the specific time t . In some cases, the modal analysis can be applied and the solution would be assumed in the following form:

$$p(r, t) = \sqrt{V} \sum_{m=0}^{\infty} T_m(t) \Psi_m(r), \quad (3)$$

where $T_m(t)$ are the time components describing the variation of an acoustic pressure in a time, and $\Psi_m(r)$ are the eigenfunctions of the enclosure which satisfy the Helmholtz equation in the general form:

$$\Delta \Psi_n(r) + \lambda_n \Psi_n(r) = 0, \quad (4)$$

where λ_n are the eigenvalues correlated with the eigenfrequencies ω_n of the enclosure by the formula $\omega_n^2 = \lambda_n c^2$. In this case, the index n means the particular eigenvalue and eigenfunction of the enclosure. Zero Neumann boundary conditions are applied on all surfaces. According to Green's theorem, if one considers the enclosure with volume V and boundary S as a bounded, positively-oriented domain, then both functions $p(r, t)$ in Eq. (1) and $\Psi_n(r)$ in Eq. (4) should satisfy the following equation:

$$\int_V (p \Delta \Psi_n - \Psi_n \Delta p) dV = \int_S \left(p \frac{\partial \Psi_n}{\partial n} - \Psi_n \frac{\partial p}{\partial n} \right) dS. \quad (5)$$

The variables t in the time components and r in the eigenfunctions are omitted in further calculations in order to simplify the notation. Applying Eqs. (1) and (4) in order to obtain the terms Δp and $\Delta \Psi_n$ and introducing the boundary conditions into the right side of Eq. (5) leads to the following equation:

$$\begin{aligned} \int_V \left(-p \lambda_n \Psi_n - \frac{1}{c^2} \frac{\partial^2 p}{\partial t^2} \Psi_n - f \Psi_n \right) dV \\ = \int_S \left(\frac{\rho_0}{Z} \frac{\partial p}{\partial t} \Psi_n \right) dS. \end{aligned} \quad (6)$$

The integrand on the right-hand side of Eq. (6) contains the boundary condition formulation for all boundaries of the enclosure. The first and the second order derivatives of the pressure, calculated on the basis of Eq. (3) take the form:

$$\begin{aligned} \frac{\partial p}{\partial t} &= \sqrt{V} \sum_{m=0}^{\infty} \dot{T}_m \Psi_m, \\ \frac{\partial^2 p}{\partial t^2} &= \sqrt{V} \sum_{m=0}^{\infty} \ddot{T}_m \Psi_m, \end{aligned} \quad (7)$$

where \dot{T}_m and \ddot{T}_m mean the first and second order derivate of time component T_m . Using Eq. (7) one can rewrite Eq. (6) as follows:

$$\begin{aligned} \int_V \left(-\lambda_n \Psi_n \sqrt{V} \sum_{m=0}^{\infty} T_m \Psi_m - \frac{\sqrt{V}}{c^2} \Psi_n \sum_{m=0}^{\infty} \ddot{T}_m \Psi_m - f \Psi_n \right) dV \\ = \int_S \left(\frac{\rho_0 \sqrt{V}}{Z} \Psi_n \sum_{m=0}^{\infty} \dot{T}_m \Psi_m \right) dS. \end{aligned} \quad (8)$$

Simultaneously, a modal analysis assumes that the eigenfunctions should be orthogonal and normalised. That means:

$$\int_V \Psi_n \Psi_m dV = \begin{cases} 0 & n \neq m, \\ 1 & n = m. \end{cases} \quad (9)$$

It enables Eq. (9) to be simplified to the form:

$$\begin{aligned} -\lambda_n \sqrt{V} T_n - \frac{\sqrt{V}}{c^2} \ddot{T}_n - \int_V f \Psi_n dV \\ = \rho_0 \sqrt{V} \sum_{m=0}^{\infty} \dot{T}_m \int_S \frac{\Psi_m \Psi_n}{Z} dS. \end{aligned} \quad (10)$$

Grouping factors with time components and its derivatives on the left-hand side and factors including the source term on the right, using simple algebraic operations, a formula similar to the equation of the forced vibration with a damping can be obtained. It takes the form:

$$\begin{aligned} \ddot{T}_n + \omega_n^2 T_n + \rho_0 c^2 \sum_{m=0}^{\infty} \dot{T}_m \int_S \frac{\Psi_m \Psi_n}{Z} dS \\ = -\frac{c^2}{\sqrt{V}} \int_V f \Psi_n dV. \end{aligned} \quad (11)$$

The time components T_n can be obtained by solving the sets of Eqs. (11). However, the eigenvalue problem of the enclosure with volume V , described by Eq. (4) and Neumann boundary condition, has to be solved initially. Hence, the correlated eigenfunctions and eigenfrequencies are known. Eventually, applying

Eq. (3), the values of acoustic pressure and its distribution in the enclosure can be determined. Two main problems arise from summation on the left-hand side of Eq. (11). The first problem is related to the time component derivatives summation and the second may arise from the infinite summation in Eq. (3). In some specific cases the problem described by Eq. (11) can be solved.

The modes coupling represented by the integrals (Eq. (11) for $m \neq n$) can be neglected in the case when the impedance Z is high enough. Subsequently, the sum can be reduced and Eq. (11) takes the form:

$$\ddot{T}_n + \rho_0 c^2 \dot{T}_n \int_S \frac{\Psi_n^2}{Z} dS + \omega_n^2 T_n = -\frac{c^2}{\sqrt{V}} \int_V f \Psi_n dV. \quad (12)$$

The above procedure allows to get the well known second order linear differential equation with constant coefficients. A homogeneous form of Eq. (12) represents a situation when one stops to emit the signal, i.e. $f = 0$, inside the enclosure and this case is considered in this paper. Because of a high value of impedance Z the non-vanishing integral value is lower than the value of coefficient ω_n . It means that the characteristic polynomial has two complex roots. The general solution in this case is the function (BŁAŻEJEWSKI, 2013):

$$T_n = e^{\alpha_n t} [C_1 \sin(\beta_n t) + C_2 \cos(\beta_n t)], \quad (13)$$

where α_n describes damping of the time component T_n and the eigenfrequency β_n for the enclosure with impedance boundary condition. This function describes the sound decrease in a transient period after the source has not been active. Constants C_1 and C_2 are dependent on the sound source f which caused a sound field before. It can be noticed that the waves in the enclosed space contain specific frequencies components which are damped with time. However, in the case of the sound waves in the enclosure, the signal frequencies depend on the enclosed space eigenfrequencies, and the attenuation depends on its boundary absorption. Therefore, the wave has a feature similar to the signal detected at the point located in some distance from the travelling acoustic source which alternately approaches and next drifts away from the point.

1.1.2. Thermally conductive and viscous

In the case of the air absorption the modified wave equation (instead of Eq. (1)) has to be considered in the following form (MORSE, INGARD, 1968):

$$\left(1 - \xi \frac{\partial}{\partial t} \right) \Delta p - \frac{1}{c^2} \frac{\partial^2 p}{\partial t^2} = f, \quad (14)$$

where quantity ξ is the relaxation time describing response of a fluid (the air) to a sudden increase in acoustic pressure. It is caused by the wave propagation

throughout the considered space. Three main phenomena appear in the fluid subjected to the acoustic pressure that influence the relaxation time: the shear flow of the fluid regions possessing different velocities, measured by the shear viscosity coefficient η ; the mechanical energy lost as the result of the fluid compression and dilatation, measured by the bulk viscosity coefficient η_B ; and finally the thermal conduction, measured by the fluid thermal conductivity coefficient κ , heat capacity at constant pressure and volume respectively C_p and C_v . Eventually, one can modify the wave equation taking into consideration the fluid absorption and introducing the following formula:

$$\xi = \frac{1}{\rho_0 c^2} \left(\frac{4}{3} \eta + \eta_B + \frac{(\chi - 1) \kappa}{C_p} \right), \quad (15)$$

where χ is the heat capacities ratio C_p/C_v . Applying the modal approach and methodology regarding modified wave equation the formula (6) has to be modified to the form:

$$\int_V \left(-p \lambda_n \Psi_n - \frac{1}{c^2} \frac{\partial^2 p}{\partial t^2} \Psi_n + \xi \frac{\partial(\Delta p)}{\partial t} \Psi_n - f \Psi_n \right) dV = \int_S \left(\frac{\rho_0}{Z} \frac{\partial p}{\partial t} \Psi_n \right) dS. \quad (16)$$

On the assumption that the high values of the acoustic impedance on boundaries exist, as the result the ordinary differential equation describing each acoustic mode of the signal and air absorption appears:

$$\ddot{T}_n + \left(\omega_n^2 \xi + \rho_0 c^2 \int_S \frac{\Psi_n^2}{Z} dS \right) \dot{T}_n + \omega_n^2 T_n = - \frac{c^2}{\sqrt{V}} \int_V f \Psi_n dV. \quad (17)$$

Again, one can assume the general solution in the form (13). In the case of the above equation the α_n describes damping of the time component T_n , which takes the form:

$$\alpha_n = - \frac{1}{2} \left(\omega_n^2 \xi + \rho_0 c^2 \int_S \frac{\Psi_n^2}{Z} dS \right). \quad (18)$$

Here α_n , in contrast to the problem without air absorption consideration (BŁAŻEJEWSKI, 2013), together with damping caused by boundaries impedance, appears additional damping introduced by the air. The eigenfrequencies β_n in (13) for damping system with the air absorption are also influenced by the parameter ξ and described as:

$$\beta_n = \sqrt{\omega_n^2 - \frac{1}{4} \left(\omega_n^2 \xi + \rho_0 c^2 \int_S \frac{\Psi_n^2}{Z} dS \right)^2}. \quad (19)$$

The relaxation time ξ in gases approximately reaches 10^{-10} s and in dry air equals $2.38 \cdot 10^{-10}$ s. It means that in the considered problem, the air absorption and the acoustic impedance affect an acoustic signal in the same way. The effect of the attenuation of the air can be neglected.

1.2. The example object applied to shape the analysed signal

In order to identify the required parameters an example object, which is the room shown in Fig. 1, has been taken into consideration. The volume of the enclosure is 45.27m^3 and the total surface area S , with varying impedance, is 84.96m^2 . 15 different surfaces are considered (e.g. walls, floor, ceiling, doors). The real acoustic impedance characterizes the walls and other boundaries in the actual object. The model of the object was built applying Finite Element Method (FEM) in order to identify the eigenfrequencies, i.e. to solve numerically Eq. (4). Because of a good separation of acoustic modes in the low frequency range, first 500 eigenfrequencies were found and taken into consideration. Hence, the sound source frequency spectrum was chosen properly (Subsec. 1.3). Two parameters should be identified in order to describe the enclosure according to the modal approach. The first one is the damping coefficient α associated with acoustic properties, e.g. reverberation time. The second one is the eigenfrequency β related to the shape and dimensions of the enclosure. Numerically identified eigenfrequencies of the object shown in the Fig. 1 are ordered in the following sequence: $\{27.3, 47.8, 61.1, 64.8, 70.3, 75.2, 78.6, 80.6, 89.1, 90.6, 92.9, 99.5, 101.9, 103.1, 111.4, 113.2, 119.7, 121.8, 122.0, \dots\}$. One can see that the first eigenfrequencies are well separated. Initial intervals are equal to a few hertzs but subsequently tend to get smaller values while eigenfrequencies

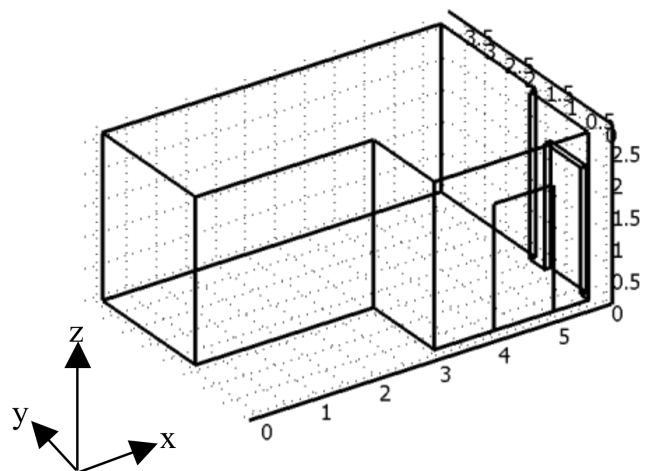

Fig. 1. The shape and dimensions of the example object examined.

cies are increasing. Thus, according to the modal approach, which is described by Eq. (3) and Eq. (13), the acoustic waves generated in the enclosed space by the source consist of components characterised by frequencies correlated with eigenfrequencies. The components should be detected in the signal measured in the enclosure. Together with characteristic frequencies (coefficient β in Eq. (13)) the components in the detected signal are characterised by the duration (coefficient α in Eq. (13)).

1.3. Experimental procedure

In order to verify the theory within the scope of the characteristic frequencies detection in the signal the experimental research was conducted. The response of the room was examined by generating an acoustic Gaussian impulse in the low frequency range. The Gaussian impulse can be described in the frequency domain by the following formula:

$$H(f_G) = \frac{1}{\sqrt{2\pi}\sigma} \exp\left(-\frac{f_G^2}{2\sigma^2}\right), \quad (20)$$

where parameters $f_G = 200\text{Hz}$ and $\sigma = 1\text{ms}$ were introduced in the excitation of the loudspeaker. The measurements were conducted as follows: the sound source was located at the point $x = 3.25\text{m}$, $y = 1.5\text{m}$, $z = 0.9\text{m}$ and a microphone was consecutively placed in separate positions (pos. 1 – $x = 4.5\text{m}$, $y = 1.0\text{m}$, $z = 1.4\text{m}$; pos. 2 – $x = 4.5\text{m}$, $y = 2.5\text{m}$, $z = 1.4\text{m}$; pos. 3 – $x = 3.25\text{m}$, $y = 2.5\text{m}$, $z = 1.4\text{m}$; pos. 4 – $x = 1.5\text{m}$, $y = 2.5\text{m}$, $z = 1.4\text{m}$) of the room as shown in Fig. 1. The signals received for four different places in the room are presented in Fig. 2. One can see that the signals are attenuated in 2–3 seconds after initiation and only the noise remains. The original acoustic signal recorded does not deliver any information except the duration of the whole signal and the variation of the pressure values. However, its feature is comparable to noise generated by vehicles passing by. The theory in Subsec. 1.1 states that the measurement contains same characteristic components which can be significant in different aspects. Therefore, it needs an additional analysis in order to extract the components.

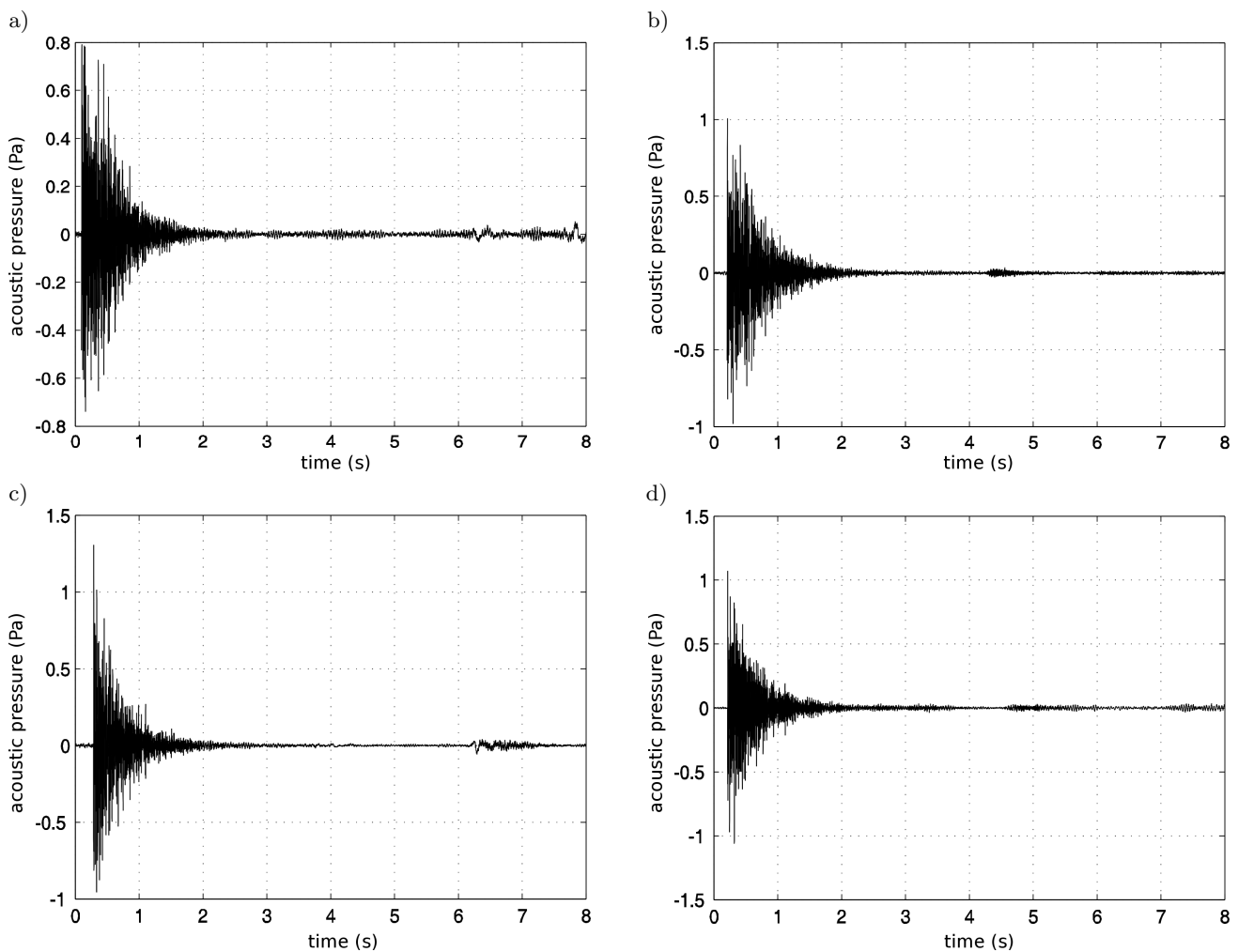

Fig. 2. The acoustic signal recorded in different places of the room: a) pos. 1, b) pos. 2, c) pos. 3, d) pos. 4 after the acoustic Gaussian impulse was emitted.

2. Fourier analysis

Afterwards, the recorded signals were analysed using time-dependent windowed Fourier transform. The time-dependent Fourier transform is the discrete-time Fourier transform computed using a sliding window. This form of the Fourier transform is also known as the short-time Fourier transform (STFT). A Hamming window with the length of 1s giving 1Hz frequency resolution was used. In Fig. 3 the spectrograms in the frequency domain show components of the received signals as the bands in the discrete frequencies and the time when they last in the signals. The specific distributions of the bands obtained after the signal analysis, which can be observed in the exact frequencies in the frequency domain and at different lengths in the time domain of the spectrograms, indicate the character of the signal generated by the source. The impulse parameter f_G in Eq. (20) determines the concentration of the components in this specific frequency neighbourhood in the spectrograms in Fig. 3. The strength of each received component is different and depends

on the receiver location and the source location. The peaks in Fig. 4 are directly correlated with coefficient β in Eq. (13) and represent only the strongest components for each receiver-source configuration. In the case of the examined object, where boundaries are characterised by relatively high values of acoustic impedance, those coefficients β are nearly equal to the eigenfrequencies.

In Fig. 4 one can observe that the frequencies values for apparent peaks are correlated with the eigenfrequencies values listed for the example object in Subsec. 1.2. The STFT ability to extract the frequencies sharply separated out of the analysed signal is characteristic for the Fourier transform. Also, it can be observed that, according to the theory, different components (correlated with acoustic modes) are attenuated in different ways. Some of them are damped more strongly than the others. The time of attenuation is directly connected with the coefficient α in Eq. (13). This attenuation and the exponential decrease are clearly seen in Fig. 5. The smooth curves represent the time components, which initial ampli-

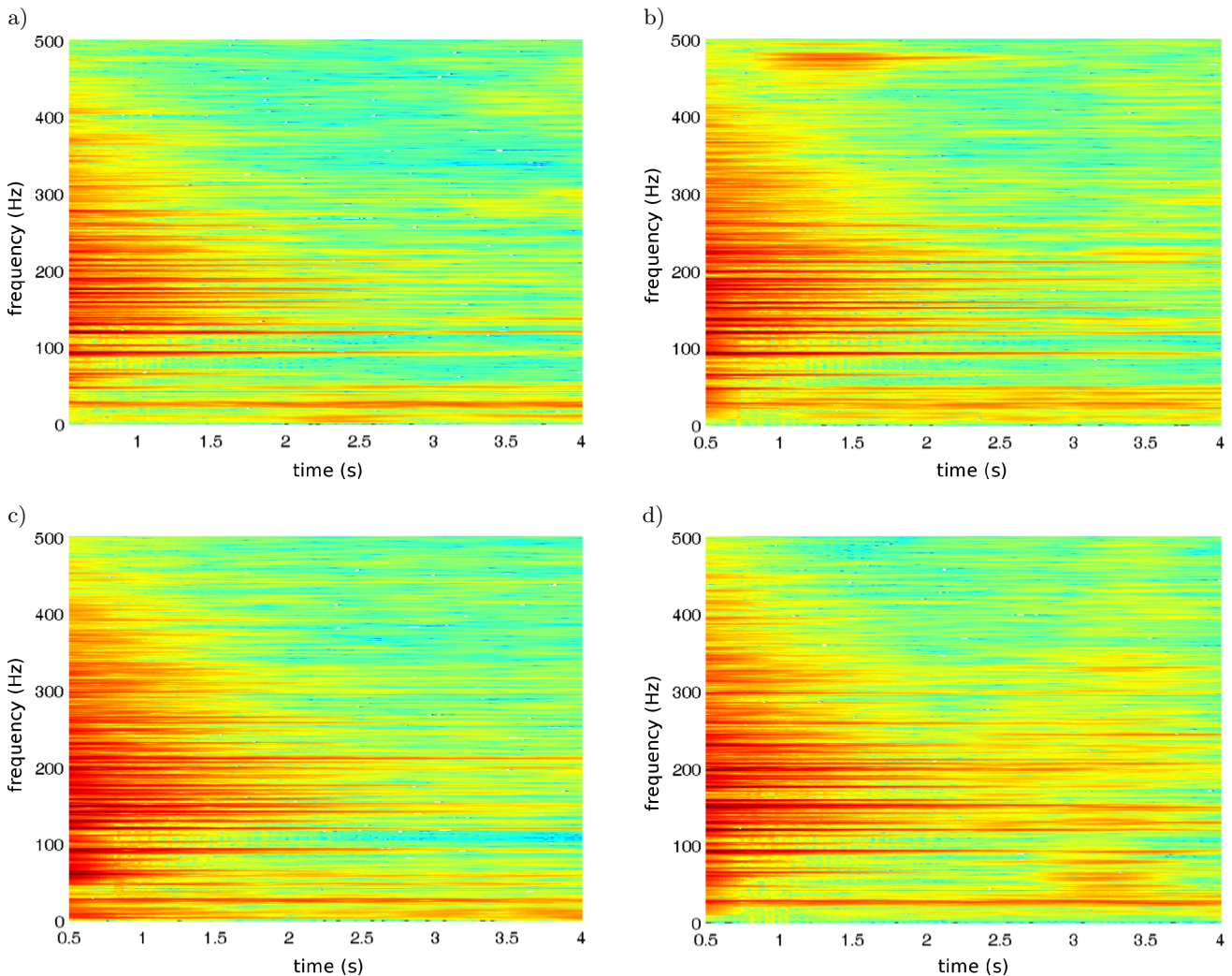

Fig. 3. The spectrograms of the signals in different locations in the room: a) pos. 1, b) pos. 2, c) pos. 3, d) pos. 4.

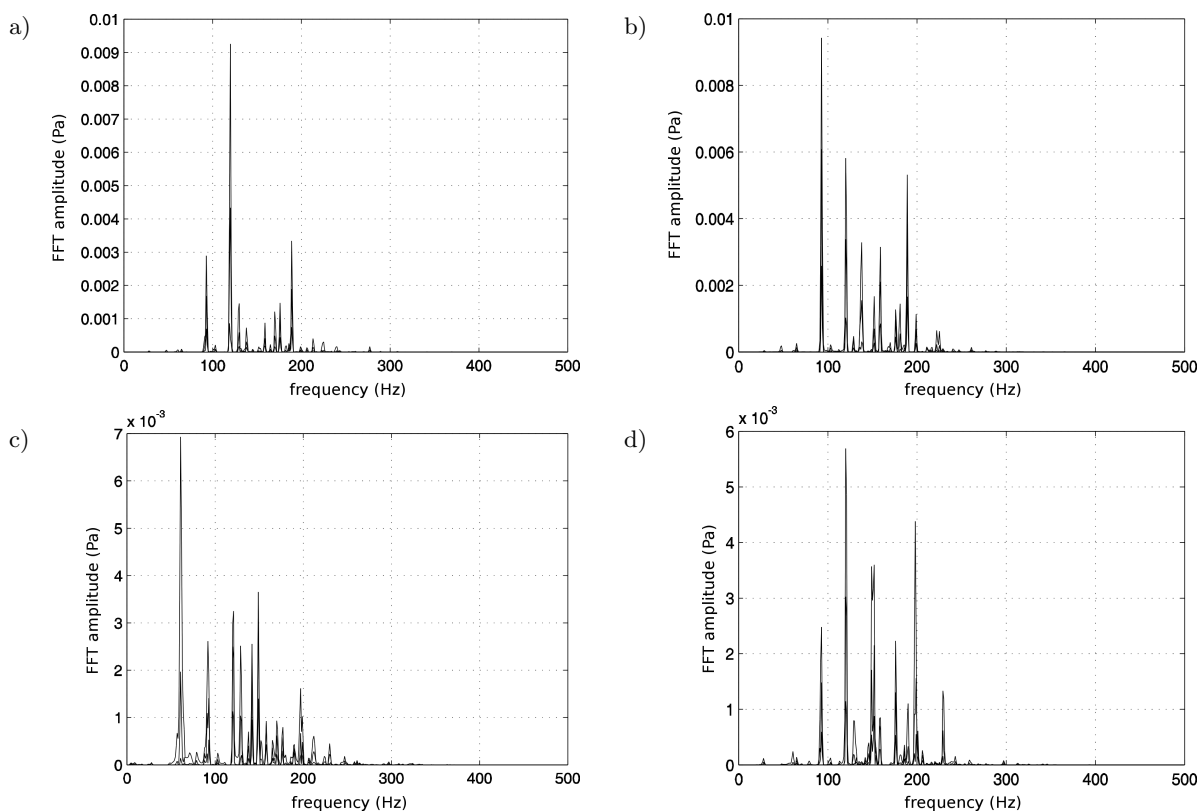

Fig. 4. Frequency analysis ($t = 0.5s$) of the signals measured in different positions inside the room: a) pos. 1, b) pos. 2, c) pos. 3, d) pos. 4.

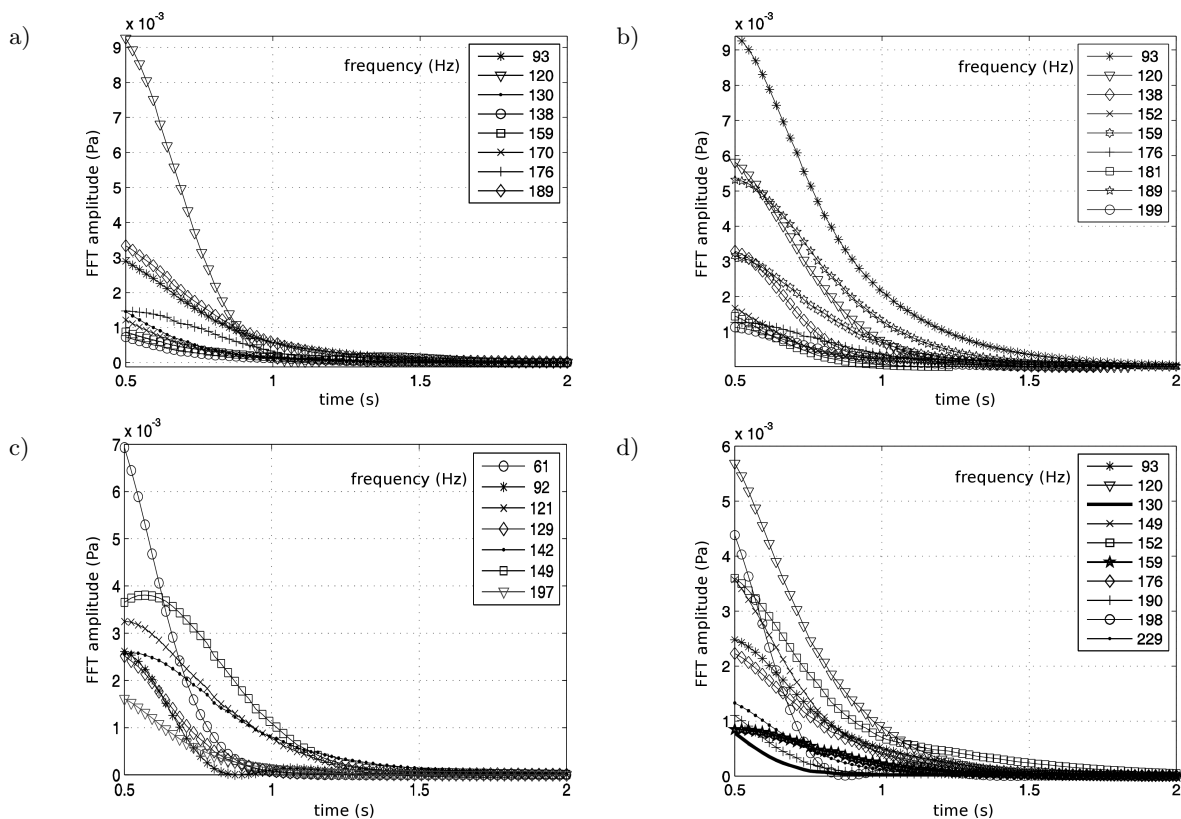

Fig. 5. The attenuation of some signals' components related to maximal values of FFT amplitudes analysed by windowed Fourier transform (see Fig. 4): a) pos. 1, b) pos. 2, c) pos. 3, d) pos. 4.

tudes as the peaks presented in Fig. 4. The frequencies of the selected components are listed for each signal in the boxes in Fig. 5. In the case of acoustical analysis of the enclosure, on the base of the frequencies configuration and the time history of the related components, one can infer about the shape dimensions of the room and eventually about its frequency characteristics. It gives the information which frequency in the propagated signal is well received, on the contrary to the others as they are strongly damped. Generally, for dynamical systems, this kind of information could be very useful and valuable. It allows to take activities at the system to improve it. For example, for a traffic noise, the oppressive components of a signal can be identified. In the next step it could be decided which components have to be reduced, or even eliminated, because they induce resonances in scrounging objects, constructions, buildings, sound barriers etc.. The information in the time domain that is the duration of some components in the measured signal, which is an output of dynamic system, characterises its ability to the attenuation of the specific frequencies. For example, in the case of vibration absorbers, noise barriers, etc. these selective features are required.

3. Wavelet analysis

A wide class of wavelet families gives the possibility of replacing the classical Fourier bases combined with a so-called “window” by functions more suitable for time analysis (MALLAT, 1998). Whereas the time information is spread in Fourier analysis, the appropriately chosen wavelet bases can give detailed information on how the analysed signal propagates in time. Signal analysis based on the wavelet approach makes a step forward, compared to a window Fourier transform, leading to the detailed analysis in frequency-time domain. The specific construction of wavelets allows building of subspaces in the integrable functions’ space with arbitrarily chosen dimensions. Therefore, the wavelet transform can be treated as a kind of “digital zoom” allowing to look inside the transformed signal as deeply as one may wish, not only on frequency axis but also, and above all, in time direction. This feature is particularly useful in dynamic systems analysis where strong variations in time appear (KOZIOL, 2010; KOZIOL, MARES, 2010; MALLAT, 1998). The signals analysed in this paper have been transformed by using the Gabor wavelet $\psi(t)$ of frequency 6 with the complex wavelet function (Fig. 6). After a series of testing simulations, this type of wavelet was chosen as the appropriate one for analysing the measured signals, in order to analyse the most wanted features in time-frequency domain. The transformed signals are presented in scalograms (Fig. 7) being equivalents to spectrograms shown in Fig. 3.

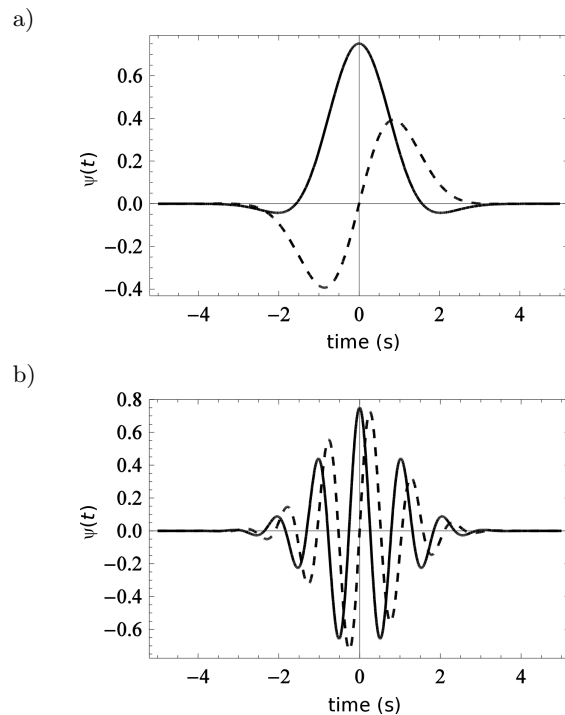

Fig. 6. The real part (solid line) and the imaginary part (dashed line) of the complex wavelet function type of Gabor: a) with frequency 1, b) with frequency 6.

Strong variations of signals can be observed when analysing the signals transformed by using Gabor wavelets (Fig. 7). It shows that wavelets have the possibility to recognise more detailed dynamic changes of signals. Therefore, the wavelet analysis can be used for the recognition of features of dynamic systems with strong variations and, consequently, it is a more reliable tool for such complex dynamics. Figure 8 shows attenuation of some signals’ components related to the amplitudes observed in Fig. 4. The frequencies of the selected components are listed for each signal in the boxes in Fig. 8. The transformed signal behaves more chaotically compared with the one obtained via Fourier transform (Fig. 5). Real physical features can be discussed when using the wavelet transform by extracting appropriate components from the transformed signal and then using the inverse wavelet transform. This kind of processing cannot be used in the case of Fourier analysis because the applied window loses important details in time. This information is spread in the transformed signal and only frequency features can be reflected fairly enough. Therefore, the curves presented in Fig. 4 are much smoother and, even if they seem “very nice” looking like associated with analytical solutions, they do not show real behaviour of the analysed system. Thus, by using the wavelet transform a number of physical and geometrical properties of the enclosure can be classified which leads to the recognition of surrounding environment with generated impulses.

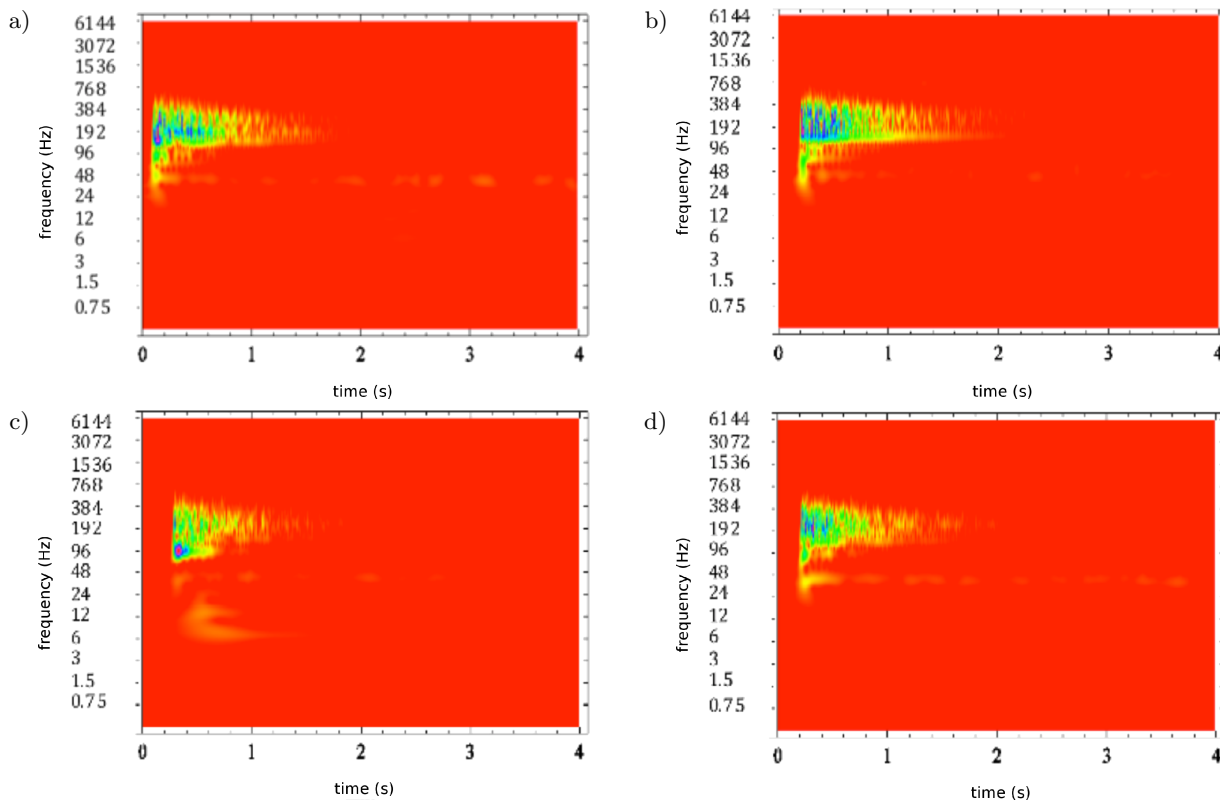

Fig. 7. Scalograms of the specified signals measured at: a) pos. 1, b) pos. 2, c) pos. 3, d) pos. 4, transformed by using the wavelet transform with introduced Gabor wavelet of frequency 6.

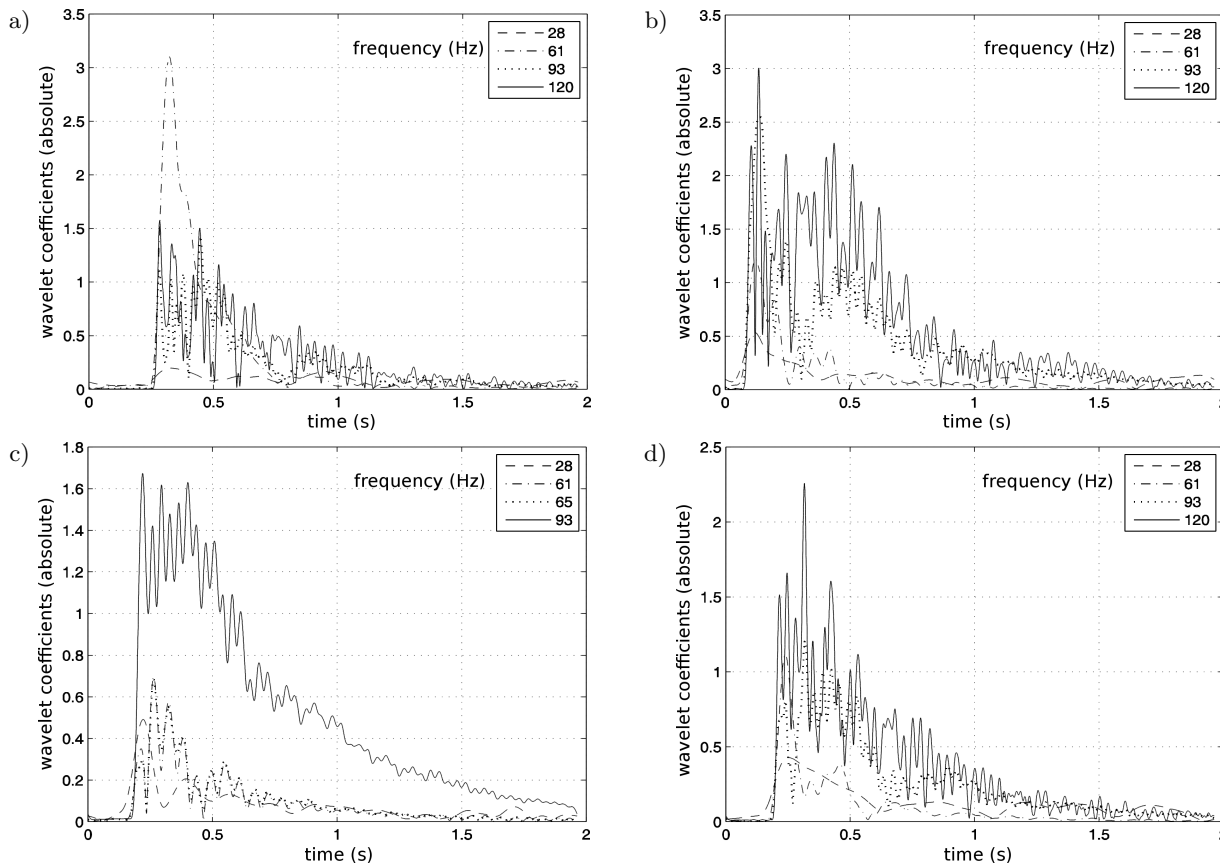

Fig. 8. The attenuation of some signals' components related to maximal values of amplitudes (wavelet coefficients) analysed by wavelets (Fig. 7): a) pos. 1, b) pos. 2, c) pos. 3, d) pos. 4.

On the basis of the carried out experimental study, one can formulate basic guidelines for acoustic signal analysis that can be also introduced for unbounded domain, e.g. the train track. Noise and vibrations generated by means of transport such as vehicles or trains have similar features, i.e. they are characterized by strong variations of specific frequency components. The study carried out for sound in the enclosure and published semi-analytical solutions for moving load problems, obtained with a use of the wavelet approximation (KOZIOL, 2010; KOZIOL, MARES, 2010; KOZIOL *et al.*, 2008), allows to presume that the creation of a consistent wavelet based methodology for analysis of dynamic effects of rail transportation on environment is possible.

4. Conclusions

The dynamical objects, or more generally systems, can generate vibro-acoustical signals. The subsystems or parts of the objects build a whole signal introducing their specific frequency components which exist in a signal specific time. Two different approaches to the signals and noises analysis are presented in the paper for the purpose of underlining their main features. These analyses were conducted for signals generated and received inside closed space, i.e. inside the room. The theoretical background was presented in order to point out special attributes of these signals such as frequencies components associated with eigenfrequencies of the room and its duration. The theoretical solution was compared with experimental measurements for a real object. In the case of the object the eigenfunctions were identified numerically and according to the theoretical solution the measured signals should contain specific components correlated with eigenfunctions. This kind of signal is assumed to be similar to signals, or more generally noises, which can be generated by means of transport. The measured signals were analysed in the frequency and time domain using the short-time Fourier transform (STFT) and the wavelet transform. Both analyses gave information regarding the signal generated by the main source, i.e. the loudspeaker, but also allowed to identify separate signals, additionally generated by other sources. One should note that the recorded signals contained the noise lasting from the beginning to the end of the measurement. It can be observed as separate bands in a low frequency range in Fig. 3 (Fourier analysis) and areas in Fig. 7 (wavelet analysis). It has been

shown that this kind of signals, with some frequencies dominating in the frequency spectrum and different characteristics, i.e. duration and variation of the frequency components, need special approach. It is proposed to conduct the analysis in two steps: the short-time Fourier analysis in order to identify the frequencies, and after that the wavelet analysis of particular frequencies. The exemplary dynamical system – the high-speed trains generate such signals, acoustical and vibrational simultaneously. The analysis of systems associated with moving loads still needs new approaches, equally in analytical and experimental study, especially when one deals with critical values appearing in the case of high speeds. The method of analysis developed in this paper, assuming the use of the short-time Fourier analysis to identify the sought frequencies and the wavelet approach for time analysis of particular frequencies attenuation, will be used for the measurements carried out in situ for real train track constructions, i.e. vibration and noise arising from operational trains.

References

1. BŁAŻEJEWSKI A. (2013), *Modal analysis application in passive sound level control inside bounded space in steady state*, [in:] *Dynamical Systems-Application*, Awrejcewicz J., Kazimierczak M., Olejnik P., Mrozowski J. [Eds.], pp. 409–421, Wydawnictwo Politechniki Łódzkiej, Łódź.
2. KOZIOL P. (2010), *Wavelet approach for the vibratory analysis of beam-soil structures: Vibrations of dynamically loaded systems*, VDM Verlag Dr. Müller.
3. KOZIOL P., MARES C. (2010), *Wavelet approach for vibration analysis of fast moving load on a viscoelastic medium*, *Shock and Vibration*, **17**, 4–5, 461–472.
4. KOZIOL P., MARES C., ESAT I. (2008), *Wavelet approach to vibratory analysis of surface due to a load moving in the layer*, *International Journal of Solids and Structures*, **45**, 2140–2159.
5. MALLAT S. (1998), *A wavelet tour of signal processing*, Academic Press Inc. Ltd, London.
6. MEISSNER M. (2008), *Influence of wall absorption on low-frequency dependence of reverberation time in room of irregular shape*, *Applied Acoustics*, **69**, 583–590.
7. MORSE P.M., BOLT R.H. (1944), *Sound waves in rooms*, *Reviews of Modern Physics*, **16**, 69–150.
8. MORSE P.M., INGARD K.U. (1968), *Theoretical acoustics*, Mc Graw-Hill.