

Energy storage systems: power grid and energy market use cases

PRZEMYSŁAW KOMARNICKI

*Fraunhofer Institute for Factory Operation and Automation IFF
Sandtorstr. 22, 39106 Magdeburg, Germany
e-mail: komarn@iff.fraunhofer.de*

(Received: 16.01.2016, revised: 08.02.2016)

Abstract: Current power grid and market development, characterized by large growth of distributed energy sources in recent years, especially in Europa, are according energy storage systems an increasingly larger field of implementation. Existing storage technologies, e.g. pumped-storage power plants, have to be upgraded and extended by new but not yet commercially viable technologies (e.g. batteries or adiabatic compressed air energy storage) that meet expected demands. Optimal sizing of storage systems and technically and economically optimal operating strategies are the major challenges to the integration of such systems in the future smart grid. This paper surveys firstly the literature on the latest niche applications. Then, potential new use case and operating scenarios for energy storage systems in smart grids, which have been field tested, are presented and discussed and subsequently assessed technically and economically.

Key words: storage technologies, storage system sizing, storage system operation, storage system management, storage system use case scenarios, storage system integration

1. Introduction

The power grid is changing rapidly in order to meet users' demand for sustainable system design as well as to provide cost effective security and quality of supply. On the one hand, more and more renewable (RES) and distributed energy sources are being installed in order to meet global targets. Over 650 GW of RES in 2014 have been installed worldwide already, see Fig. 1. This will continue to rise because of diverse regional or local factors (e.g. solar radiation or winding zones) ensuing from the grid structure and the market.

On the other hand, energy consumption on the European continent, which exceeded 20,000 TWh in 2014, is rising very differently (different demographic trends and energy efficiency actions) [1]. The factors cited (dynamics of generation and consumption) and new functions, roles and actors that can be incorporated in the complete power grid (smart grid and smart market [2]) are significantly increasing demands for transport capacities to make the particular grid structure and the respective grid operators' operating mechanisms responsive.

These new requested capacity cannot always be met by conventional measures such as grid expansion alone and, above all, not fast enough and cost effectively [3]. Both precise RES production projections [4, 5] and, thus, more efficiently plannable RES use [6] along with measures to make loads responsive [7, 8] will be essential for future flexibility. Only these together with new components that increase the power grid's responsiveness, e.g. energy storage systems [9] in local power systems [10], can guarantee corresponding security and reliability of supply of the future smart grid.

Renewable Power Capacities* in World, EU-28, BRICS, and Top Seven Countries, 2014

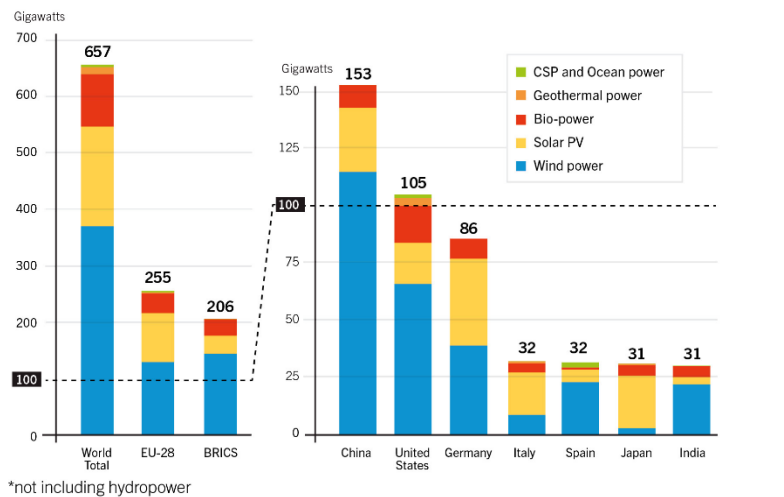

REN21 Renewables 2015 Global Status Report



Fig. 1. RES installed worldwide in 2014 [11]

The storage system capacity currently installed worldwide is estimated to be 140 GW [12] and the integration of an additional 310 GW in the grid is deemed to be necessary to continue reducing CO₂ emissions in the power grid in coming years. Since storage technologies, especially innovative ones, are still quite expensive, it is always essential to analyze their individual and combined use cases/operating scenarios separately both technically (storage system sizing: capacity, out-put, dynamic response) and economically (mode of operation and benefit-cost) in order to be able to define an optimal storage system (technology and parameters).

Section 2 of this paper describes existing storage technologies and the state of their development, addressing both technological advantages and disadvantages and the current state of potential niche applications for technology development. Section 3 describes the underlying approach to optimizing storage system design and Section 4 presents potential storage system use case scenarios and essential parameters. Section 5 evaluates the latest niche applications. Section 6 presents findings from the implementation of a real 1 MW storage system and its operation in current energy market applications. Section 7 is the conclusion.

2. Storage system technologies

Storage technologies can basically be divided in four groups according to the energy they store:

- chemical,
- electrical,
- mechanical,
- thermal.

Storage technologies have different properties (see Section 3) which predestine or eliminate them for particular use cases. Moreover, storage systems are in different stages of technical development and testing, see Fig. 2. Some technologies, e.g. adiabatic compressed air energy storage or hydrogen storage, are still in early stages of technological development. Although large-scale demonstration projects, e.g. lithium battery storage systems, are slowly extending long-established and commercialized storage systems such as pumped-storage power plants, an eye still has to be kept on their cost.

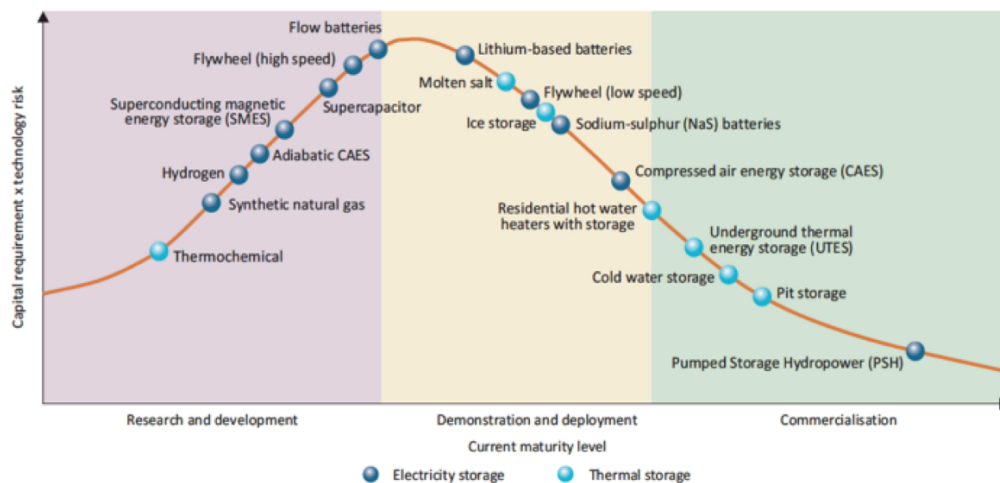

Fig. 2. Types of storage systems and their stages of development [14]

2.1. Chemical storage systems

The conversion of electricity into chemical compounds constitutes one of the most widespread storage technologies, particularly to supply power in the consumer sector (mobile devices) and to keep infrastructure running (e.g. telecommunications). These are almost exclusively low-temperature, primarily lead-acid and lithium-ion batteries and high-temperature, primarily sodium-sulfur batteries called internal storage systems since their energy level and output are interdependent. External storage systems, on the other hand, have the advantage of independently sizable output and energy parameters. Both hydrogen/methane systems and redox-flow batteries, which typically require more space, are representative of this group. The basic technical parameters of chemical storage systems are compiled in Table 1. Since they are

generally connected to the grid by power electronics (now classified as rapid and reliable), this group of storage systems can cover a very wide range of use cases in power grids.

Table 1. Technical parameters of chemical storage systems [14, 15]

Battery type	η %	Power density W/kg	Energy density Wh/kg	Self-discharge	P installation costs €/kW	E installation costs €/kWh
Li-ion	to 95	100-185	120-200	5%/month	150	180-600
Redox flow	to 75	N.A.	30-70	0.4%/day	1500	150
NaS	to 75	250	200	10%/day	200	150-600
H ₂ / methane	to 40	1000	580-33,300	<1%/month	2000	6

2.2. Electrical storage systems

Electrical storage systems typically do not require any secondary material to store electricity. Storage often takes place directly in a static electric or constant magnetic field. Since they can charge and discharge very rapidly, such systems are generally employed as power storage systems. As it stands now, the very low energy density (<10 Wh/kg) and comparatively high self-discharge rate (up to 25 % in 48 h) make only their use as short-term energy storage systems technically and economically expedient [14, 15]. Supercapacitors and superconducting coils are the best-known representatives of the two field technologies.

Electric double-layer capacitors

Electricity is stored in electric double-layer capacitors by using polarized electrodes that build up an electric field (capacitor) to separate the positive and negative charge carriers. They can absorb or release energy with high specific powers (up to 18 kW/kg) at excellent efficiencies (up to 95%) within very short time (<10 ms) [14, 15]. For the aforementioned reason, potential use of such storage systems is focused on use cases with brief high power requirements since their energy densities (up to 10 Wh/kg) are ten to fifty times lower than those of batteries [14]. New separator materials are doubling and tripling energy densities while maintaining performance values and cycle stability. Service and energy costs diverge very greatly. Whereas costs of up to € 200 per installed kW are comparable to those of lithium batteries, the specific energy costs of as much as € 20 000/kWh far exceed those of other storage technologies [15].

Superconductive magnetic energy storage systems

Superconductive magnetic energy storage systems (SMES) store electricity in a magnetic field induced by the charging current. Lossless storage requires cooling the coil with liquid helium to approximately 4.2°Kelvin (−269°C) [14]. Like electric double-layer capacitors, such a system can rapidly supply or receive very high specific power (up to 1 kW/kg) at high efficiencies (95%) with virtually unlimited charge cycles [14]. Its lower energy density (up to 5 Wh/kg) and self-discharge caused by high-energy cooling are characteristic of short-term energy storage systems [17]. The new investigations show that also the superconductivity by special materials can be reached by 91°K (so called high temperature superconductivity)

which make more attractive the SMES for the future [16]. Since such systems are still prototypes, reliable data on specific energy and service costs are not available yet.

2.3. Mechanical storage systems

Pumped-storage, flywheel energy storage and compressed air energy storage are representative mechanical storage systems.

Pumped-Storage Systems (PSS)

This is the most widespread type of a storage system in the world (99% of all energy storage systems in the electrical grid are pumped-storage power plants). After decades of use, their components have been optimized and substantial cost cuts are no longer to be expected. Since they have comparatively low energy density because of water's incompressibility, the use of these storage systems with a typical energy to power ratio has been optimized for two to eight hour operation [15]. Unlike battery storage systems, potential sites for such units are contingent on geographic constraints and are usually located far away from the load centers. Economically, PSS presently constitute the most cost effective option for storing electricity (€ 1000/kW to € 20/kWh) at a high efficiency (up to 82%) [15]. Fundamental advantages of such large energy storage systems are their rapid controllability and the resultant contribution to system reliability [18].

Flywheel energy storage systems

The use of rotational energy makes it possible to store energy and to supply power very quickly. A rotor suspended in a vacuum by magnetic bearings absorbs electricity with a comparatively high efficiency of 90-95% [14]. Significant draw-backs are its high self-discharge rate (complete from 1 h to 10 h) and its low energy density (less than 100 Wh/kg) [14]. On the other hand, flywheel energy storage systems have high cycle stability (million range) and specific power (up to 1800 kW/kg) [14, 18].

Compressed air energy storage

Compressed air energy storage (CAES) systems use compressed air stored in caverns as an energy carrier. Since the heat added to the cooled air during discharge is produced by burning natural gas, these systems are easily 50% less efficient than pumped-storage power plants. The development of adiabatic compressed air energy storage, which has significantly better efficiencies, has been pushed as the use of renewables and future storage requirements have grown [19].

2.4. Thermal storage systems

At present, coupling electrical and thermal storage systems to store excess power (power-to-heat) is treated as unidirectional heat production, e.g. in district heating systems or in private households (heat pumps). Since the useful heat produced loses so much energy that thermodynamic reconversion is inexpedient, high-temperature, thermoelectric energy storage systems, which are currently in development, are suited for this. A high performance heating system produces temperature of around 500°C in a solid storage system (magnesium oxide rocks or salts) during charging. The high heat during discharge is employed to heat a steam

cycle by a heat exchanger. The options for use are comparable to those of pumped-storage and compressed air energy storage units, i.e. as typical twenty-four hour storage systems. Its low efficiency and thermal losses when it is not in operation are drawbacks. Advantages are the availability of standard power plant components and the free choice of location (as opposed to pumped-storage and compressed air energy storage units).

3. Storage system sizing

Their technology and properties (short-term or long-term, power gradients, maximum capacity relative to area), render storage systems unsuitable for every use case. This makes it essential to size and design the storage systems and to select their technology, size, and parameters case-by-case.

Sizing begins by defining a storage system's specifications derived from the use case. Maximum power (P_{st}), maximum capacity (E_{st}) and power gradient (α_{st}) play a crucial role, see Fig. 3. These parameters and the specifications of the intended use, e.g. prequalification criteria for use as operating reserve, are factored in when selecting the technology.

Then, ambient criteria for storage system use, e.g. grid conditions and/or climatic conditions, are introduced and augmented by economic and technical factors and assessment criteria relevant to the use case (capital expenditures and service life). In every use case, the outcome of the sizing procedure is optimized storage technology with predefined parameters (power, capacity and power gradient). If, for instance, the use case "integration of intermittent renewable, e.g. wind or solar, power generation in an autonomous system" were analyzed, first the residual load and, then, the necessary storage system capacity would have to be ascertained following this procedure, see Fig. 4. This would be optimized in the subsequent steps.

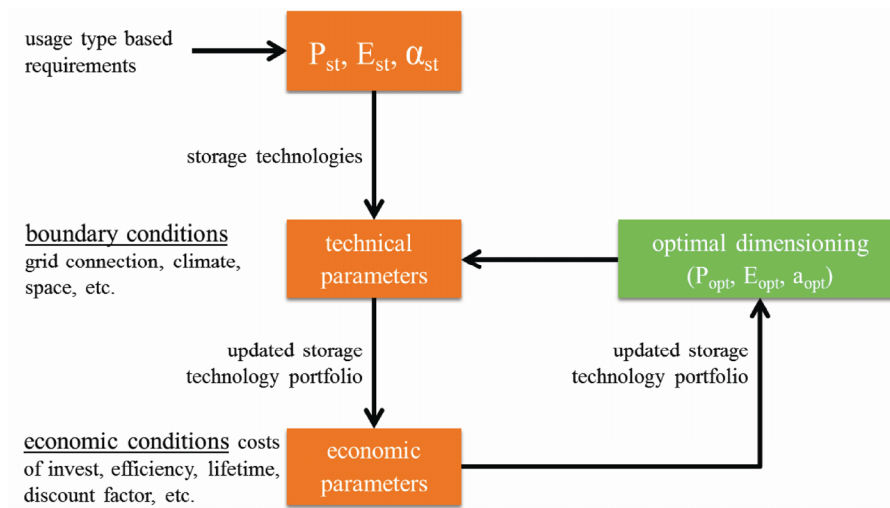

Fig. 3. Storage system sizing procedure

The residual load profile (P_{res}) ensues from the difference between renewable energy generation and load requirements. A residual load with a value of zero, see Fig. 4, constitutes a situation, in which the system (storage systems, RES and load) is balanced. A residual load curve with a value other than zero indicates that the system is unbalanced, positive values representing excess generation, negative values increased load. A storage system designed for autonomous microgrid operation must be able to cover both demand ensuing from load requirements and demand ensuing from renewable energy generation, see Eq. (1) to Eq. (2), η being the total efficiency of the charge and discharge processes [20].

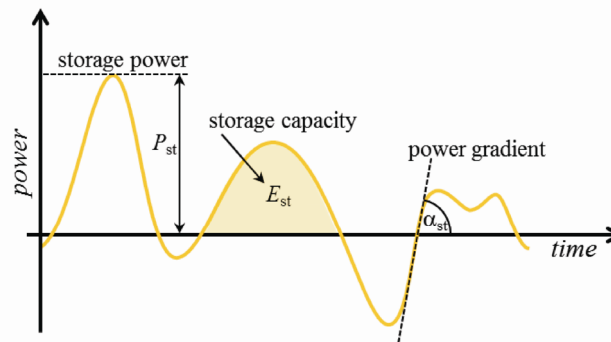

Fig. 4. Energy storage system sizing to balance residual loads

$$P_{St} = \max |P_{res}|, \quad (1)$$

$$C_{St} = \max(E_{St}) = \max_{t=1}^{t_{\max}} \left(\int_{t_i(P_{res}=0)}^{t_{i+1}(P_{res}=0)} P_{res} dt \right), \quad (2)$$

$$\alpha_{St} = \max_{k=1}^{k_{\max}} \left(\frac{\Delta P_k}{\Delta t_k} \right). \quad (3)$$

Some energy storage systems (EES) such as batteries may have higher storage capacity than that estimated by Eq. (2). The reason for this is the relation between the depth of discharge (DOD) and the ESS's service life. Some batteries, e.g. in the lithium-ion family, deteriorate quickly when charged to maximum capacity and then fully discharged. Battery aging has to be factored in to guarantee full capacity throughout its lifetime.

The storage capacity determined according to Eq. (2) is not always the cost optimum. It should be determined by a cost-benefit analysis of ESS use. A procedure for determining optimal storage capacity entails estimating the costs and the benefits at the capacity analyzed, according to Eq. (2). This constitutes the starting point for the optimization process. A sensitivity analysis successively evaluates the correlations between the costs and the benefits by varying the storage capacity (increasing or decreasing it in relation to the starting point). The storage capacity value that maximizes the benefits (if they exist) or minimizes the costs constitutes the

optimal storage capacity. In some situations, not using an ESS may be the best option from an economic standpoint [20].

4. Storage system use cases

Storage system use cases and functions can basically be divided into those beneficial to the market and those beneficial to the grid, see Fig. 5. Use cases beneficial to the grid describe options of storage system use that have a positive, short, medium or long-term impact on the operation of the electrical grids, i.e. compliance with the permitted limits of grid parameters (frequency, grid voltage, line current) [21]. Scenarios beneficial to the market pursue the goal of putting the storage system to use with value added, specifically factoring in the energy market and its constraints [22]. Some of the cited use cases, e.g. the supply of reserve power, are definitely already technically feasible. Others will only become feasible in the future as products of storage system development as the energy market evolves (market design) and constraints or electrical grids, e.g. local operability, short-circuit power supply or electric vehicle systems, are modified. Moreover, some technologies cannot be used for every use case because their physical and technological properties do not meet the demands imposed (e.g. no prequalification since they are too slow to supply operating reserve or self-discharge is too high for long-term storage system use) and are thus inefficient. Furthermore, individual use cases should be examined and analyzed from the perspective of the particular stakeholders and their roles [23] (see Fig. 5).

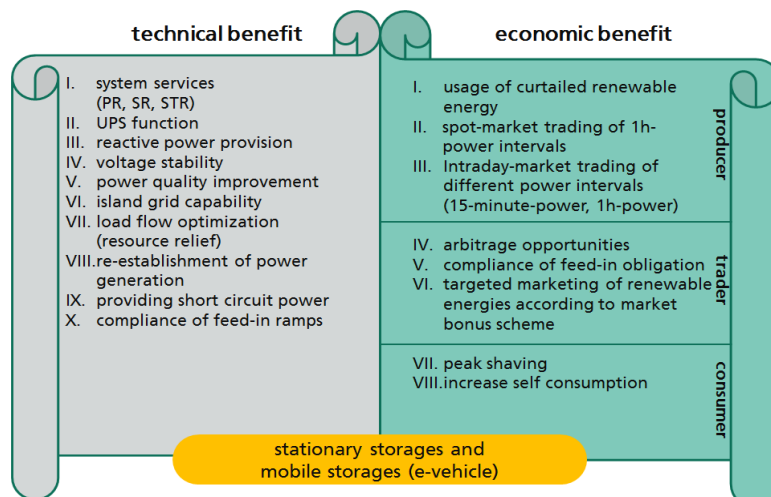

Fig. 5. Storage system use cases

The efficiency of the individual scenarios under present conditions (frequency of implementation/use and commercial and regulatory constraints) was analyzed based on real data from a German distribution grid. Previous analyses have revealed that the use of storage systems in

specific cases, i.e. not merely in a use case scenario, is not economically viable, specifically because of very high capital expenditures (storage system price), nonexistent mechanisms for planning certainty (persistence of the law of the market, e.g. an incentive model, or stability of pricing of operating reserve supply), and existent or nonexistent market conditions (commercial unavailability of some services such as grid quality or reduced load on components).

This necessitates optimized coupling of storage system use, i.e. operation for more than one use case scenario in order to establish ongoing and widespread use of storage systems. In this case Section 6 presents the first findings from use of a real battery storage system incorporating operation based on a potential scenario of multiple use cases.

5. Latest niche storage technologies

Market launches of storage technologies are impeded by the high purchase prices. Applications that facilitate and advance developments are needed to cut costs. That is why there has been a strong trend toward niche energy storage systems in recent years. For instance, hydrogen installations have been tested and evaluated in the residential sector (and on small scale) [24] and processes of reversible electrolysis have been analyzed [25, 26]. Flywheel energy storage systems [27, 28] or supercapacitors [29] are being used to recover energy or to stabilize the running of electric drives. The latest studies of electric vehicles for anticipated mass use are especially promising, thus suggesting that the efficiency of storage systems will improve. Different batteries usually come into consideration here, both for traction and services beneficial to the grid. Different field trials have already been concluded [30]. The batteries are also being optimized to electrify vehicles [31, 32]. Smart buildings are also a popular and wide field for the testing of storage technologies. On the one hand, wide-ranging energy management systems (EMS – Energy Management System) are being developed and implemented for autonomous system [33] taking into account dynamic DMS [34] and optimal control strategies [35] also for hybrid [36] and PV-Wind combined supply [37] which utilize both stationary and mobile batteries as well as thermal storage systems to integrate RES optimally [38]. On the other hand, installations have been created, which facilitate systematic peak shaving in buildings [39], thus cutting the power input to buildings as well as connection costs.

Many studies are continuing to examine the use of energy storage systems combined with PV installations [40] since they are particularly well suited for EMS because of the good options for forecasting [41].

Materials research [42] is also instrumental in cutting the cost of storage technologies. Essential studies of lithium sulfate [43], redox flow [44] and vanadium redox [45] are being pushed at present, to mention but a few examples. System development can also contribute to spreading storage systems better. The use of standardized modules cuts manufacturing and sales costs substantially [46]. This necessitates in-depth technical and economic analysis of applications to define standard battery sizes, e.g. 20 kW/1.5 h [47]. Moreover, studies of second battery cell life deserve attention since they indirectly affect system costs by increasing service life and eliminating disposal. This entails continuing to use battery cells that no longer

meet the demands of their originally intended use in another application [48]. Typical examples are mobile applications with high energy density demands for their first use and use in stationary storage systems in which energy density only plays a subordinate role for their second use.

6. Findings from the operation of a 1 MW battery storage system

6.1. Smart grid energy storage system

A lithium technology container (40 ft. container weighing 26 tons), designed as a mobile application, is being employed to test optimized strategies of storage system operation, see Fig. 6.



Fig. 6. SGEES

The Fraunhofer Institute for Factory Operation and Automation IFF's Smart Grid Energy Storage System SGEES has a maximum charge/discharge of 1 MW and an effective storage capacity of 0.5 MWh. The system has two main transformers for operation in the medium (10 kV) or low voltage (0.4 kV) grid. The full functional schema of the SGEES including inverters and ICT structure has been given in Fig. 7.

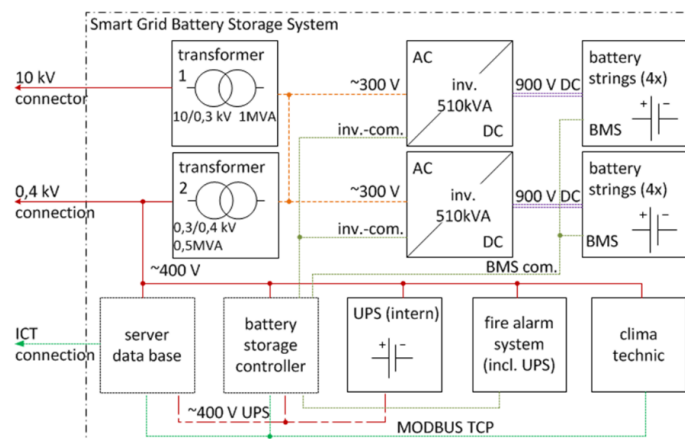

Fig. 7. SGEES circuit diagram

The storage system consists of a battery chamber with over 5000 single cells interconnected in eight lines into twelve modules apiece and two inverters in the control room. The battery system has its own HVAC system (to cool or heat the battery chamber) and a separate UPS that supplies critical control and protection components.

6.2. SGEES field trial

This storage system is currently connected in Europe’s largest photovoltaic park with an installed power of 145 MWp. The photovoltaic park covers around 250 ha and is connected to the 110-kV distribution grid by a nearby substation.

A) PV standby supply use case

During the day, the battery charges power generated at the photovoltaic park in order to minimize both energy costs to supply the park (i.e. peripheral equipment such as inverters standby, monitoring equipment, etc.) at night and the SGEES’s own standby energy requirements. Charging is done in the even hours before sundown based on the algorithm implemented, see Fig. 8. The charge criterion entails entering the nighttime power supply with a SOC of 100% in order to minimize the power consumed. The price difference between feed-in tariffs and power consumed yields the potential reduction of the photovoltaic park’s operating costs.

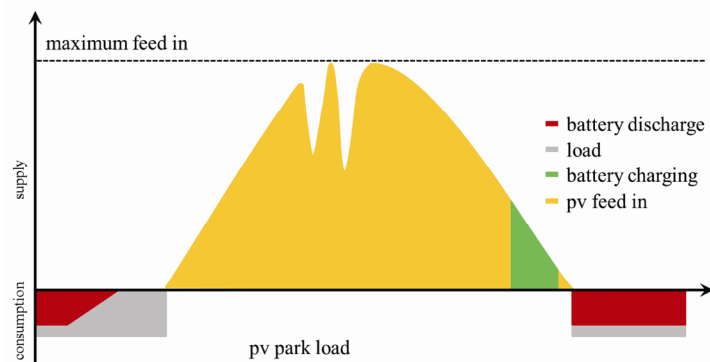

Fig. 8. Working principle of the PV and SP standby supply (nighttime) use case

This reduces costs for power imported to the photovoltaic park’s infrastructure and the battery by around 40% every year, see Table 2.

Table 2. Cost analysis of the PV and SP standby supply (nighttime) use case

Parameter	Value
electricity costs (nighttime)	€ 53 875
electricity costs with battery use	€ 34 470
savings	€ 19 404
electricity not purchased	€ 34 772
losses p.a.	€ 15 367

Inputting power into the battery entails drawing off power normally supplied to the grid with a corresponding loss of revenue (subtraction of the amount of battery energy from the Renewable Energy Act feed-in tariff). In addition, efficiency and energy consumption have to be factored into storage system operation.

This ultimately yields a loss of around € 15 000 every year, excluding capital expenditures and routine repair and maintenance costs.

B) Acceptance of curtailed energy use case

Since renewables are subject to grid security actions and can be curtailed externally, e.g. by grid operators, to assure grid stability, a storage system makes it possible to store and use such normally compensated but physically unutilized power, see Fig. 9.

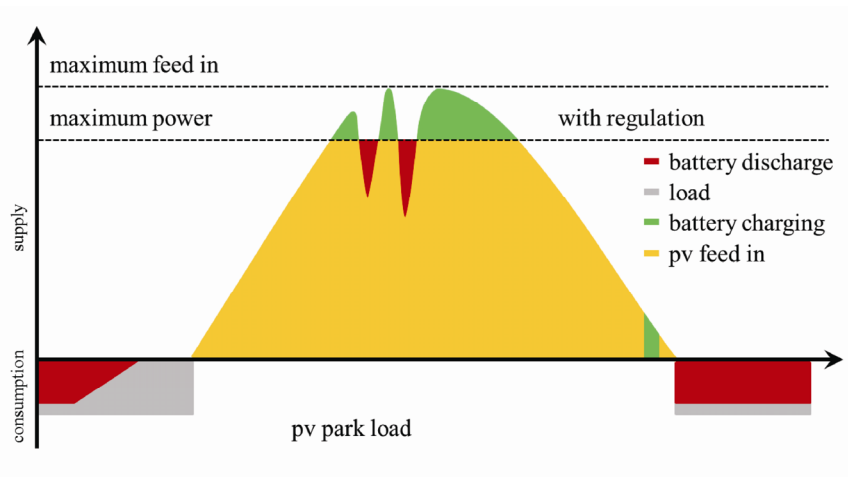

Fig. 9. Working principle of the curtailment use case

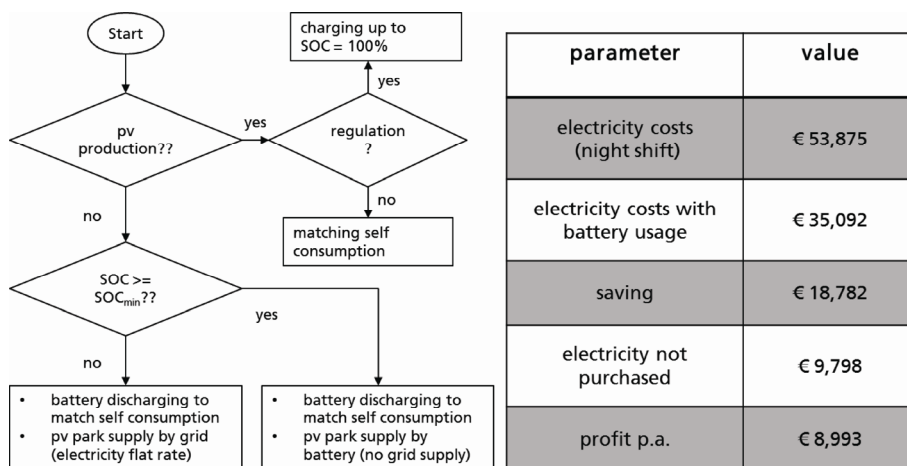

Fig. 10. Schematic and cost analysis of the curtailment use case

In this case, the battery system is on standby during the day (PV production period) for a curtailment command from the grid operator and draws needed standby power (i.e. battery HVAC system, control equipment) from PV generation, see Fig. 10. As soon as a curtailment signal is received (e.g. because of grid security actions), the battery is charged with the appropriate charging power.

When the curtailment signal ceases, the battery discharges to equalize the power supplied by the PV park (schedule/projection revision) and to supply free capacities for the next curtailment period, as a reading in Fig. 11 shows. The profit is twice that of the first case and the power is not physically destroyed as it normally would be when grid security actions are applied.

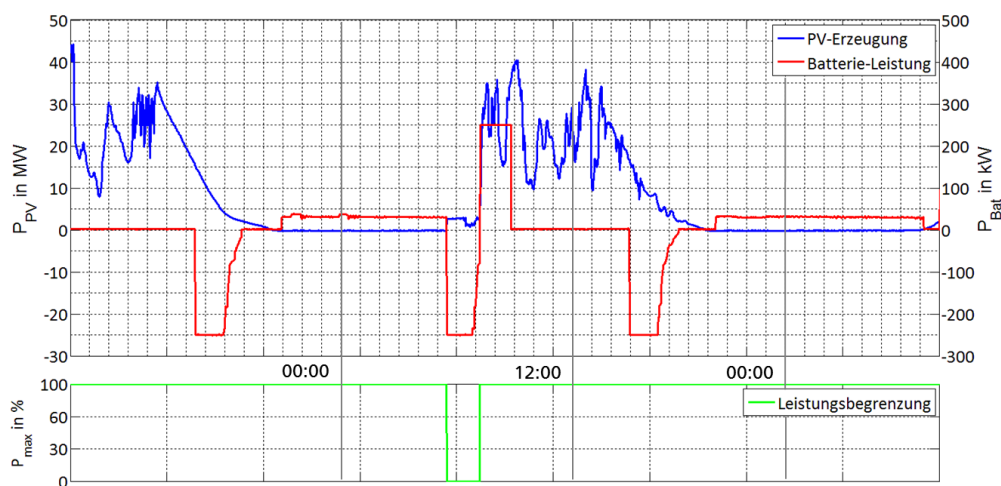

Fig. 11. RES installed worldwide in 2014 [11]

C) Basic and intraday trading use case

In use case c, market influences are added to the control system. In the field trials presented, this means that the battery is charged during curtailment or when market prices are low and, rather than being recovered directly (see the curtailment use case), the power is optimized for periods of higher revenue, i.e. periods in which power can be sold at a higher price, see Fig. 12. This use case scenario additionally assures that the battery is fully charged for the nighttime scenario in order to be additionally able to minimize expenditures for purchased power.

The findings obtained reveal that, factoring in changed market conditions, a potential increase of profits could be anticipated. This does not suffice, however, to operate the battery cost effectively when capital expenditures and maintenance costs as well as service life and cycle stability resulting from the technology are factored in. Consequently, other multiple use cases, i.e. optimal coupling of the use case scenarios in Fig. 5, factoring in basic grid and market conditions, have to be sought in order to be able to cover the high purchase price of such storage systems.

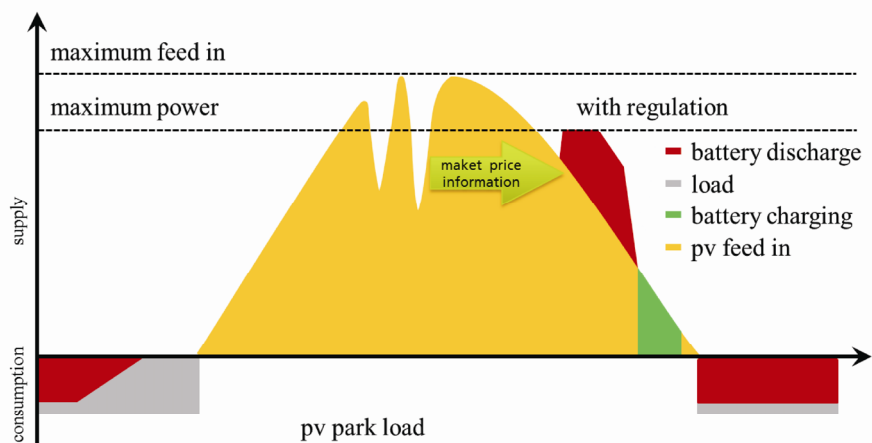

Fig. 12. Working principle of the basic and intraday trading use case

7. Conclusion

Diverse storage system technologies in widely varying stages of development are currently commercially available. On the one hand, years of experience exist with small storage systems such as lead-acid batteries or large energy storage systems such as pumped-storage power plants. Such systems are not always able to meet the demands of present grid and market developments (service life, power gradients and efficiency). On the other hand, significant new technological developments, such as redox-flow for small storage systems or adiabatic compressed air energy storage for large systems, are emerging on the market. Very frequently, highly scalable prototypes or basic experience with use in the field, i.e. pilot applications, are still lacking. This makes continued research to develop and test new technologies absolutely essential.

Implementing an economic and technical use case from the existing technology portfolio requires defining standard tools that size storage systems and establishing planning certainty for capital expenditures and reliable basic conditions, since this is unfeasible otherwise, particularly because of the substantial capital expenditure this entails. Experience with the operation of storage systems in the field (installation, maintenance and reliability) has to continue being expanded in order to be able to turn pilot systems into reliable and competitive products. Studies reveal that there are practical use cases, e.g. reduced load on equipment or increased utilization of the potential of renewables, definitely exist but these cannot yet be capitalized on commercially because of the absence of revenue. Utility companies compensate plant operators for the curtailed and thus unutilized power described in this paper and pass these costs along to consumers. Storage system use that generates revenue can reduce the costs incurred by grid bottlenecks. The simulations and field trials carried out make clear that the testing of

other use cases as well as the optimization of combined use case scenarios and the development of potential new use case scenarios will be essential in the future.

References

- [1] <https://yearbook.enerdata.net>, accessed November 2015.
- [2] Buchholz M., Styczynski Z., *Smart Grid Fundamentals and Technologies in Electricity Networks*, Springer (2014).
- [3] Netzentwicklungsplan 2014, Factsheet, Inhalt, Konsultation, Sensitivitäten und weiteres Verfahren, www.netentwicklungsplan.de
- [4] Bridier L., David M., Lauret P., *Optimal design of a storage system coupled with intermittent renewables*, *Renewable Energy* 67: 2-9 (2014).
- [5] Quan D.M., Ogliari E., Grimaccia F. et al., *Hybrid model for hourly forecast of photovoltaic and wind power*, IEEE International Conference on Fuzzy Systems, no. 6622453 (2013).
- [7] Mathiesen B.V., Lund H., Connolly D., et al., *Smart Energy Systems for coherent 100% renewable energy and transport solutions*, *Applied Energy* 145: 139-154 (2015).
- [8] Kondziella H., Bruckner T., *Flexibility requirements of renewable energy based electricity systems – A review of research results and methodologies*, *Renewable and Sustainable Energy Reviews* 53: 10-22 (2016).
- [9] Stötzer M., Hauer I., Richter M., Styczynski Z.A., *Potential of demand side integration to maximize use of renewable energy sources in Germany*, *Applied Energy* 146: 344-352 (2015).
- [10] Styczynski Z.A., Stötzer M., Müller G., et al., *Challenges and barriers of integrating e-cars into a grid with high amount of renewable generation*, 44th International Conference on Large High Voltage Electric Systems, p. 9 (2012).
- [11] Lombardi P., Styczynski Z.A., Sokolnikova T., Suslov K., *Use of energy storage in Isolated Micro Grids*, Power Systems Computation Conference PSCC, no. 7038361 (2014).
- [12] Renewables 2015, *Global Status Report*, *Renewable Energy Policy Network for the 21st Century*, <http://www.ren21.net>.
- [13] Styczynski Z., Lombardi P., Seethapathy R., et al., *Electric energy storage and its tasks in the integration of wide-scale renewable resources*, Integration of Wide-Scale Renewable Resources Into the Power Delivery System, CIGRE/IEEE PES Joint Symposium (2009).
- [14] Technology Roadmap Energy Storage, International Energy Agency, OECD/IEA, <https://www.iea.org/publications>, accessed (2014).
- [15] Mayer T., Sandurkov B., *Evaluierung der Weiterverwendung gebrauchter Lithium-Ionen-Zellen aus der Elektromobilität und Marktübersicht Hausbatterien*, EKFAuftragsstudie SWD-10.08.81-12.11 (2013).
- [16] Fuchs G., Lunz B., Leuthold M., Sauer D.U., *Technologischer Überblick zur Speicherung von Elektrizität*, Smart Energy for Europe Platform GmbH (SEFEP) (2012).
- [17] Subramanian M.A., Torardi C.C., Calabrese J.C., et al., *A New High-Temperature Superconductor: Bi2Sr3-x Cax Cu2O8+y*, *Science* 26, 239(4843): 1015-1017 (1988).
- [18] Rehman S., Al-Hadhrami L.M., Alam M.M., *Pumped hydro energy storage system: A technological review*, *Renewable and Sustainable Energy Reviews* 44: 586-598 (2015).
- [19] Deutsches ClenTech Institut DCTI, *Speichertechnologien 2013 – Technologien, Anwendungs-be-reiche, Anbieter* (2013).
- [20] Lombardi P., Röhrig Ch., Rudion K., et al., *An A-CAES pilot installation in the distribution system: A technical study for RES integration*, *Energy Science & Engineering* 2(3): 116-127 (2014).
- [21] Cigré WG C6.15, *Electric Energy Storage Systems*, Paris (2011).
- [22] Cho J., Kleit A.N., *Energy storage systems in energy and ancillary markets: A backwards induction approach*, *Applied Energy* 147: 176-183 (2015).
- [23] Brijts T., De Vos K., De Jonghe C., Belmans R., *Statistical analysis of negative prices in European balancing markets*, *Renewable Energy* 80: 53-60 (2015).

- [24] Liu J., Fang W., Zhang X., Yang C., *An Improved Photovoltaic Power Forecasting Model With the Assistance of Aerosol Index Data*, IEEE Transactions on Sustainable Energy 6(2), no. 7029108: 434-442 (2015).
- [25] Cholewiński M., Tomków L., *Domestic hydrogen installation in Poland Technical and economic analysis*, Archives of Electrical Engineering 64(2): 189-196 (2015).
- [26] Kingsbury R.S., Chu K., Coronell O., *Energy storage by reversible electro dialysis: The concentration battery*, Journal of Membrane Science 495: 502-516 (2015).
- [27] Xu M., Ivey D.G., Xie Z., Qu W., *Rechargeable Zn-air batteries: Progress in electrolyte development and cell configuration advancement*, Journal of Power Sources 283(20743): 358-371 (2015).
- [28] Baszyński M., Siostrzonek T., *Flywheel energy storage control system with the system operating status control via the Internet*, Archives of Electrical Engineering 63(3): 457-467 (2014).
- [29] Baszyński M., Piróg S., *Determining the mechanical losses in a high-speed motor on the example of a flywheel energy storage system*, Archives of Electrical Engineering 61(3): 299-313 (2012).
- [30] Kozłowski M., *Application of supercapacitors to recuperate energy in diesel-electric locomotives*, Archives of Electrical Engineering 54(212): 205-224 (2005).
- [31] Heuer J., Komarnicki P., Styczynski Z.A., *Integration of electrical vehicles into the smart grid in the Harz.EE-mobility research project*, IEEE Power and Energy Society General Meeting, no. 6039147 (2011).
- [32] Rothgang S., Rogge M., Becker J., Sauer D.U., *Battery design for successful electrification in public transport*, Energies 8(7): 6715-6737 (2015).
- [33] Ren G., Ma G., Cong N., *Review of electrical energy storage system for vehicular applications*, Renewable and Sustainable Energy Reviews 41: 225-236 (2015).
- [34] Lombardi P., Sokolnikova T., Suslov K., Styczynski Z.A., *Optimal storage capacity within an autonomous micro grid with a high penetration of renewable energy sources*, Innovative Smart Grid Technologies (ISGT Europe), 3rd IEEE PES International Conference and Exhibition on. IEEE (2012).
- [35] Moskalenko N., Wenge C., Pelzer A., Komarnicki P., Styczynski Z.A., *Energy Management System with dynamic component control for efficiency optimization*, IEEE PES ISGT Europe 2012, pp. 1-7 (2012).
- [36] Moskalenko N., Lombardi P., Komarnicki P., *Control strategies and infrastructure for a dynamic energy management system (DEMS)*, IEEE Grenoble Conference PowerTech, no. 6652455 (2013).
- [37] Sharafi M., El Mekawy T.Y., Bibeau E.L., *Optimal design of hybrid renewable energy systems in buildings with low to high renewable energy ratio*, Renewable Energy 83: 1026-1042 (2015).
- [38] Hussein, A.A., Batareseh, I., *Energy management for a grid-tied photovoltaic-wind-storage system - Part II: Operation strategy*, IEEE Power and Energy Society General Meeting, no. 6672414 (2013).
- [39] Gude V.G., *Energy storage for desalination processes powered by renewable energy and waste heat sources*, Applied Energy 137: 877-898 (2015).
- [40] Zheng M., Meinrenken C.J., Lackner K.S., *Smart households: Dispatch strategies and economic analysis of distributed energy storage for residential peak shaving*, Applied Energy 147: 246-257 (2015).
- [41] Parra D., Gillott M., Norman S.A., Walker G.S., *Optimum community energy storage system for PV energy time-shift*, Applied Energy 137: 576-587 (2015).
- [42] Zavadil R., *Renewable generation forecasting: The science, applications, and outlook*, Proceedings of the Annual Hawaii International Conference on System Sciences, no. 6480115: 2252-2260 (2013).
- [43] Assresahegn B.D., Brousse T., Bélanger D., *Advances on the use of diazonium chemistry for functionalization of materials used in energy storage systems*, Carbon 92: 362-381 (2015).
- [44] Manthiram A., Chung S.-H., Zu C., *Lithium-sulfur batteries: Progress and prospects*, Advanced Materials 27(12): 1980-2006 (2015).
- [45] Ha S., Gallagher K.G., *Estimating the system price of redox flow batteries for grid storage*, Journal of Power Sources 296: 122-132 (2015).

-
- [46] Cunha A., Martins J., Rodrigues N., Brito F.P., *Vanadium redox flow batteries: A technology review*, International Journal of Energy Research 39(7): 889-918 (2015).
- [47] Rothgang S., Baumhöfer T., van Hoek H., et al., *Modular battery design for reliable, flexible and multi-technology energy storage systems*, Applied Energy 137: 931-937 (2015).
- [48] Herlender K., Styczynski Z., Dominik H., Prokhovnik A., *Determination of a Battery Storage Module Size for Distribution*, Distributed Energy Storage for Power Systems, Aachen, Verlag Mainz ISBN 3-89653-3363 (1998).
- [49] Balischewski S., Wenge C., Roehrig C., Komarnicki P., Styczynski Z.A., *Zellenrecycling im stationären Batteriespeicher. Zellselktion, Speicherkonzeption und Systemtests*, 5th Power & Energy Summer Summit 2013 (PESS'13), IEEE Student Branch, pp. 23-25 (2013).