

Investigations of optical interferometric structures applied in toxic gas sensors

Z. OPILSKI¹, T. PUSTELNY^{1*}, E. MACIAK¹, M. BEDNORZ¹, A. STOLARCZYK²,
and M. JADAMIEC²

¹Department of Optoelectronics, Silesian University of Technology, 2 Krzywoustego Str., 44-100 Gliwice, Poland

²Department of Physico-Chemistry and Polymer Technology, Silesian University of Technology, 9 M. Strzody Str., 44-100 Gliwice, Poland

Abstract. In recent years organic semiconductors have been given attention in the field of active materials for gas sensor applications. In the paper the investigations of the optoelectronic sensor structure of ammonia were presented. The sensor head consists of polyaniline and Nafion layers deposited on the face of the telecommunication optical fiber. The elaborated sensor structure in the form of Fabry-Perot interferometer is of the extremely small dimension – its thickness is of the order of 1 μm . Many sensor structures of different combinations of the polyaniline and Nafion layers were constructed and investigated. The optimal solution seems to be the structures with small number of polyaniline layers (up to three).

Key words: optical fiber gas sensors, the Fabry-Perot interferometer, sensor structures with organic semiconductors.

1. Introduction

The ecological consciousness of the societies has grown in recent years with the progress of industrialization and the degradation of the natural environment. Hence the concern about the preservation of nature and safety has become apparent, as well as a lawful compulsion of safety in industry, and public places. Many world known centres of science have focused their attention on developing effective gas sensors, and on investigations of sensor materials. Since 1990 optochemical methods of gas detection have become more popular [1]. Their main advantages, compared with conventional electrical methods, are their resistance to electro-magnetical interferences, a fast response time, functionality in flameable atmospheres. Optochemical sensors, combined with standard optical telecom fibres and integrated optics systems, provide an opportunity to create integral optical remote sensing systems.

In optical sensors the detected gas can interact with a sensor layer in many different ways, modifying its optical properties (index of refraction, absorption coefficient, etc ...). The changes of optical properties can be measured in various experimental set-ups. The most common methods mentioned in the literature are: changes of absorption spectra [1], measurements of reflectance changes [2], variations of the intensity of luminescence [3], evanescent wave analysis – based methods [4], surface plasmon resonance methods (SPR) [5,6], interferometric methods [6]. In this work the optoelectronic sensors of ammonia based on the Fabry-Perot interferometer are presented.

2. Polymers as interesting sensing materials

In recent years polymers have been given a great attention in the field of active materials for gas sensor applications. There is a wide opportunity of developing polymer-based gas sensors due to the variety in the structure of polymers and versatility of chemical and physical interactions between the analyte and the polymer sensor layer [7].

Among conducting polymers, investigated as materials for polymer-based gas sensors of especial interest is polyaniline (PANi). The electrical conductivity of polyaniline can be easily modified by doping it with metals, semiconductors or various chemical substances. Also the high environmental stability and redox properties of polyaniline, connected with nitrogen atoms in the polymer chain, are very interesting for sensor applications. In comparison with polypyrrole and polythiophene the processing of polyaniline is relatively easy, due to the high solubility of polyaniline in organic solvents [8].

The structure of the PANi chain, presented in Fig. 1, can be expressed by the general formula [8]:

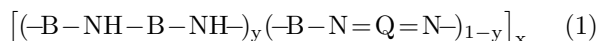

where, B and Q denote the C_6H_4 ring in benzenoid and quinoid form, y denotes the oxidation state varying from 0 to 1.

Polyaniline occurs in many different forms which vary in their chemical and physical properties. The intrinsic oxidation state of PANi can have the value of $y = 0$ for fully oxidized *pernigraniline* (PNA), through 50% oxidized *emeraldine* EM – $y = 0,5$, and finally $y = 1$ for fully reduced (*leucoemeraldine*) (LM, $y = 1$) [8,9].

*e-mail: tpustelny@polsl.pl

Z. Opilski, T. Pustelny, E. Maciak, M. Bednorz, A. Stolarczyk, and M. Jadamiec

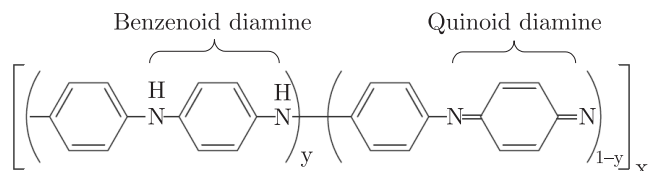

Fig. 1. Structure of the polyaniline chain structure (base form) (after Ref. 9)

The most important feature that makes polyaniline so interesting and feasible as a sensor layer for the detection of toxic gases is the variation of its electrical and optical properties. The variation occurs with protonation and deprotonation process during its interaction with gas, which changes the doping state of PANi. The low price of the polymerization substrates and high efficiency of the polymerisation process are also very significant [10,11].

3. Ammonia sensing system – the set-up and the principle of its operation

The idea of the presented optical ammonia sensor is based on variations of reflected light spectra resulting from interactions of ammonia with the sensing layer. The sensor is an optrode-type optical fibre sensor. The system monitors the light reflected from the face of the fibre.

The sensor head consists of polyaniline and Nafion[®] layers deposited on the face of the fibre (Fig. 2). Nafion[®] (DuPont product) is a copolymer of tetrafluoroethylene (Teflon[®]) and perfluoro-3,6-dioxo-4-methyl-7-octenesulfonyl fluoride. Nafion[®] is highly resistant to chemical effects but the presence of its exposed sulfonic acid groups displays unusual properties. Sulfonic acid has a very high water-off-hydration, absorbing 13 molecules of water per every sulfonic acid group in the polymer. Consequently, Nafion[®] absorbs 22% by weight of water [12].

The refraction index of Nafion[®] was estimated by means of the Abbe refractometer, and its value was equal to 1.364 (5% solution in a mixture of water with lower alifaticalcohol).

In the sensors standard telecommunication fibres were used (within the range of the first telecommunication window – 850 nm). As light sources a white LED or an incandescent lamp were used. The lamp ensures a high intensity of light in the red and near infrared range, where strong variations of the reflected spectrum were expected, in effect of ammonia action on the sensor structures.

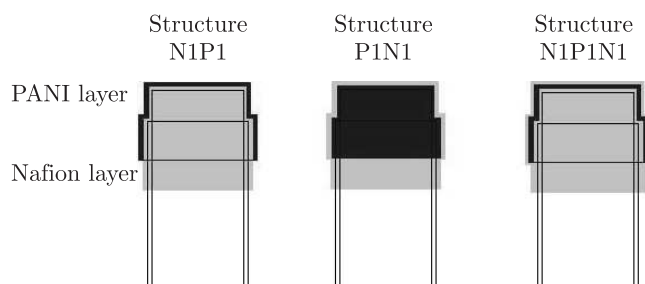

Fig. 2. Scheme of the sensor heads

In Fig. 2 the first head is formed by the sensing layers: Nafion[®] (once deposited in technological process on the top of optical fiber, and hence depicted as N1) and polyaniline (also once deposited on the fiber with N1 layer, depicted as P1). The second head forms: polyaniline and Nafion[®], deposited in this order (P1N1) and the third head: polyaniline Nafion[®]-polyaniline-Nafion[®] layers (1P1N1P).

4. Technology of gas sensors

The polyaniline solution was obtained by polycondensation of an oxidized aniline in an acidic environment. A solution of 2.25 cm³ freshly distilled aniline and 1 mole solution of sulphuric acid was prepared. After the dissolution of the precipitated aniline sulfate the mixture was cooled in a refrigerator for about 2 h at temperature of ~ 5°C.

Simultaneously a solution of the oxidizer (5.7 g) – ammonium persulfate dissolved in 1 mole of sulfuric acid solution, was prepared. The oxidizer solution was also cooled down for 2 h at ~ 5°C. After cooling, the solutions were mixed together in a beaker for 1 h and then left for 24 h at room temperature (~ 18°C). Subsequently the polyaniline was filtered off and next it was rinsed with sulphuric acid solution and left to dry (at room temperature). The discussed PANi was doped with camphoro-sulfonic acid and deprotonated by mixing with a 1-mole solution of ammonia.

Deprotonated PANi (50 mg) was introduced to 5 cm³ N-metylopirolidone (NMP) and after mixing left for 2–3 days. Then, the solution was filtered. The filtrate was a homogeneous solution of polyaniline in N-metylopirolidone.

Polyaniline and Nafion[®] were deposited on the face of the fibre by immersion of the optical fiber in earlier prepared solutions. In the case of PANi, the fibre was immersed in solution of PANi for 30 minutes. Subsequently it was dried in a vertical position at 110°C for 24 hours. In order to deposit some PANi sensor layers, the fibre was heated after its immersion and then left for 1h, and next these processes were successively repeated. In the case of Nafion[®] the immersion lasted only 30 s, and the fibre was then dried at 40°C for 24 h. The deposition of multilayers of Nafion[®] involved a successive 30 s immersion and 20 minutes drying. The described method is simple from the technological point of view. The layer thickness seems to depend on the viscosity and adhesive force, it is to be assumed that the concentration is roughly constant at a constant temperature of deposition, amounting to 18°C.

5. Interaction of ammonia with the sensing layer

The protonation reaction with HA type acid can be expressed by the formula:

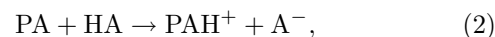

where: PA and PAH⁺ denote the repeating block of the polymer chain before and after protonation. In Figure 3

the scheme of the process of protonation of polyaniline is presented. During the protonation reaction of PANi a molecule gains proton, creating an energetically more favourable chemical N^+H bond. The N^+H bonds form positive charge centres. The valence electrons can relocate between those charge centres, increasing the p type conductivity.

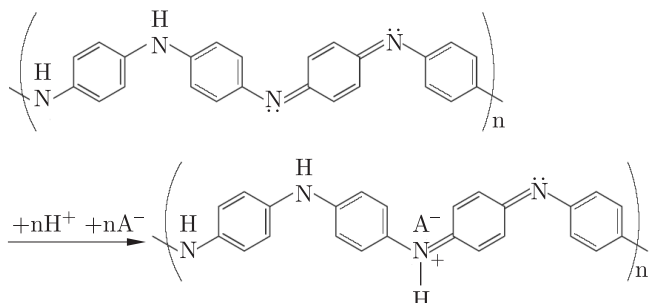
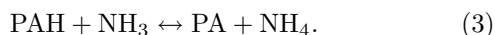

Fig. 3. Scheme of the protonation of PANi. The repeating block of the PANi chain, before (the emeraldine base) (top), and after the protonation (after Ref. 11)

In contact with a reduction gas (NH_3 , H_2S) the protonated form of PANi is susceptible to the redox reaction. The interaction of PANi (the protonated emeraldine salt ES) with ammonia can be described by the formula:



In the presence of ammonia the reaction proceeds mainly towards the right-hand side: the NH_3 molecules reach the surface of PANi, react with the NH groups of the polymer chain, and gain their protons forming the energetically more favourable ammonium NH_4^+ , which remains near the acid radicals A^- . The reaction quoted above describes the deprotonation of PANi to the emeraldine base form (EB). In air, without constant flow of ammonia, the reaction (3) starts towards the left side. The ammonium NH_4^+ decomposes into ammonia NH_3 (which volatilizes) and proton, which – absorbed by PANi recovers the initial state of doping – with ES. Hence the reversibility and regeneration of the sensor is achieved [11,13].

6. Investigation of the sensing structures

The spectrum analysis is performed by SpectroART-14.1 spectrometer, whose spectral range is 380 nm – 780 nm. (The spectrometer is based on a reflection grating and a CCD array with 256 pixels.) The experimental set-up is presented in Fig. 4.

(The connection between the fiber with the investigated sensor and the fibre from the coupler is ensured by a capillary tube connector, with an immersion liquid that provides no reflection at the connector.)

The sensor response to ammonia concentration changing from 78 ppm to 5000 ppm was measured. The sensor was exposed to ammonia/synthetic air mixture in 200 seconds cycles. Each mixture cycle was followed by a pure

synthetic air cycle, resulting the regeneration of the sensor (by protonation of PANi). The additional dynamic regeneration was ensured by Nafion[®].

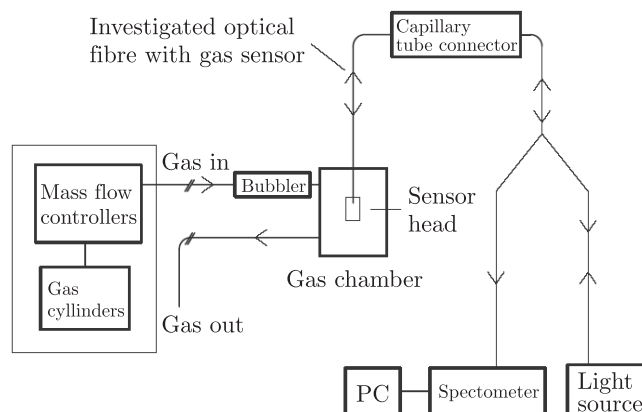

Fig. 4. Experimental set-up

Many sensor structures of different thicknesses and combinations of the polyaniline and Nafion[®] layers were constructed and investigated. The optimal solution seems to be structures with small number of PANi layers (up to two). In the structures with a greater amount of PANi layers a strong attenuation of the reflection light was observed and the output signal was weak. Simultaneously the NH_3 molecules cannot penetrate the sensing layer deep enough to reach the lower layers. Hence, the multi-layer structures seem to be useless in that case.

6.1. The interferometric sensor structures. The structure of the optical fiber sensor of the type: glass-PANi-Nafion[®]-air is presented in Fig. 5. The light is reflected at the boundaries: PANi-glass, PANi-Nafion[®] and Nafion[®]-air. In the gas sensor of essential importance is the reflection at the boundary PANi-glass and PANi-Nafion[®]. Those two reflection mirrors have been forming the resonant cavity. The two reflected beams interfere with each other. The interference image can be observed in reflected light that reaches the CCD array of the spectrometer. The optical properties of the cavity and the mirror are altered by the effect of NH_3 which determines the position of the interference fringes.

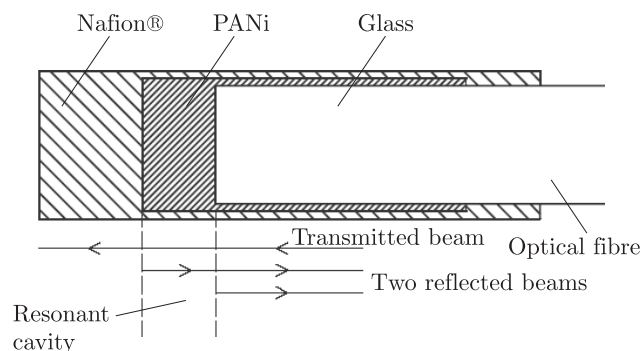

Fig. 5. Sensor head in the structure of the interferometer (the scale is not maintained)

In order to analyse the interferometric structure presented above a numerical system has been elaborated. The numerical system allows to analyse the sensing structure for many arbitrary layers concerning their various optical and geometrical parameters. In the experimental characteristics and numerical calculations the number of extremes and their location in the spectra were compared. Figure 6 presents the experimental results of interference and Fig. 7 the results of numerical calculations.

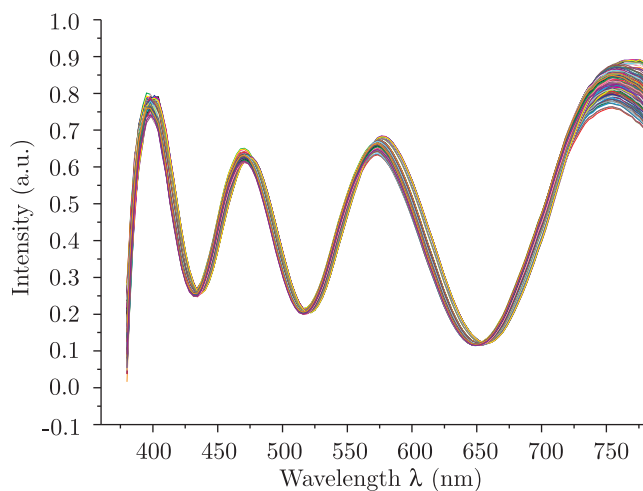

Fig. 6. Reflected light relative intensity changes for the P2N1 structure; the subsequent curves represent the spectrum successively

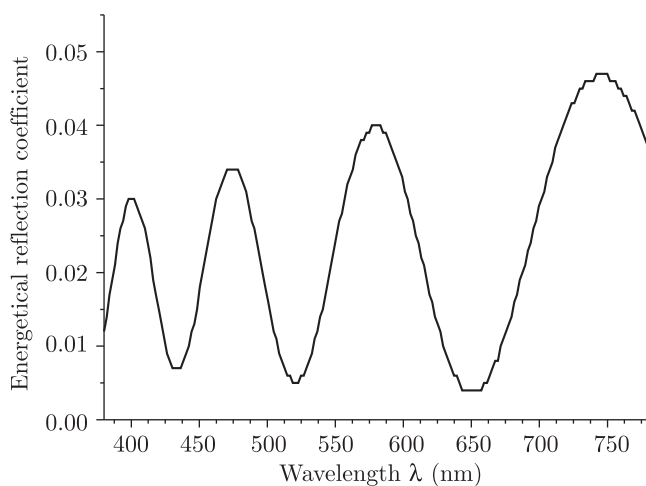

Fig. 7. Interference spectrum of the numerical characteristic of the P2N1 structure

The values of the refraction index of Nafion[®] n_N and the refraction index of polyaniline n_P were determined for the best conformity the experimental and theoretical characteristics. On the base of the best conformity of the complex indices of the refraction of Nafion[®] ($n_N = 1,364 + 0j$) and PANi ($n_P = 1,9 + 0,06j$) have been assumed. Fixing the thickness of layers one can observe that the thickness of the Nafion[®] layer does not influence the

interference, which means that the cavity is formed by PANi-glass and PANi-Nafion[®] boundaries. This is very probable because the contrast of the refraction indices between PANi-glass and PANi-Nafion[®] is bigger than between Nafion[®] and air. The size of the cavity (the thickness of the PANi layer) can be estimated by matching the measured and simulated image. From the estimation influences that the thickness of PANi layer is about 690 nm.

The most optimal structure, with respect to sensor properties, is a structure with two layers (deposited in two processes) of PANi and one layer of Nafion[®] at the top. (For us, the experimental structure of this kind was signed as P2N1. The thickness of PANi layers (estimated by our program) was about 690 nm.

The properties of the sensor are presented in Fig. 8. The sensor response to changes of the ammonia concentration can be obtained by analysing the position of the fringe maximum. Figure 8 presents also the regeneration of the sensor properties after the ammonia flow suppression. The regeneration is caused partly by the presence of Nafion[®] in the sensor structure.

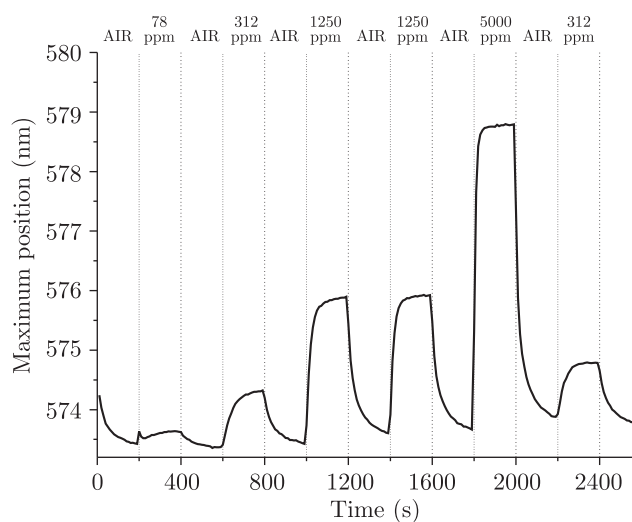

Fig. 8. Maximum position variations at 540 nm–600 nm for the P2N1 structure, in response to ammonia concentration changes

The characteristics show rapid responses of the sensor after the ammonia flow has started. The slow drift in the direction of higher values of frequency after stopping of the gas flow has been observed, too. The drift results from competitive processes of adsorption and desorption of the analyte in the sensor layer. Both mechanisms were considered in [14]. A small drift of a whole curve and the lack of total regeneration – returning the maximum to the initial position (572 nm) seem to be caused by the too short step of a single time period (200 s) in the gas cycles. A longer time step should provide a better regeneration. (This problem will be investigated in further researches.)

6.2. Other sensing structures. Figure 9 presents the results of investigations concerning the structure which consists of two polyaniline layers (P2) (without Nafion[®]) deposited on the top of the optical fiber. Figure 10 presents the results of investigations of the structure: two layers of Nafion[®] and polyaniline (N2P1). The sensor responses are obtained by analysing the changes of the reflected light intensity at a given wavelength (730 nm).

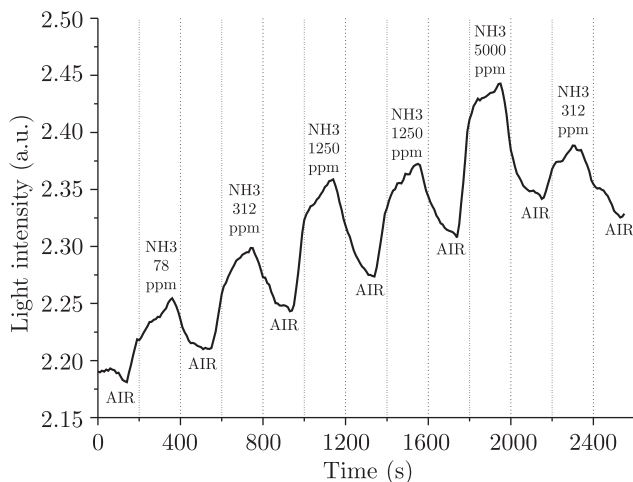

Fig. 9. Relative intensity changes of the reflected light for the P2 sample, at 730 nm

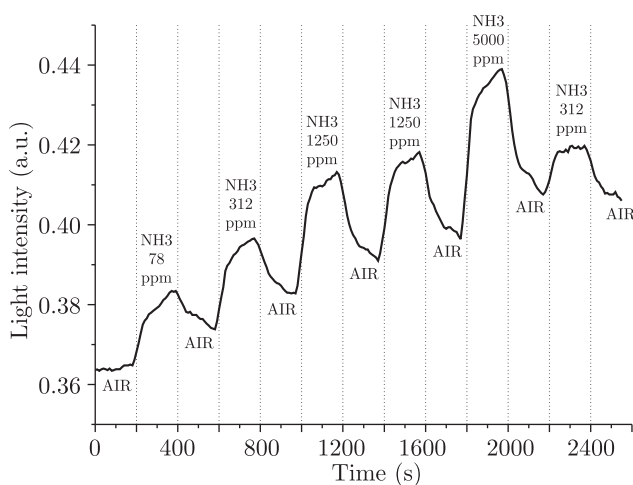

Fig. 10. Relative intensity changes of the reflected light for the N2P1 sample, at 730 nm

The character of the regeneration of the sensor depends on the presence of Nafion[®] in the sensing structure. The relative sensitivity to the effect of ammonia action is higher in the structure with Nafion[®]. It is confirmed by the theoretical conclusions [11].

The measurements have shown that the “sandwich” structures (Nafion[®]-PANi-Nafion[®]) are too thick. The signal reflected from such a structure is strongly attenuated. Also the protonation of polyaniline is very fast, because there are Nafion[®] layers on both sides of polyani-

line. Hence the sensor cannot respond to ammonia because it is immediately regenerated.

Our investigations have also shown that the elaborated sensor structures are not sensitive to NO₂. The interferometer structure P1N1 proved to be immune to NO₂ up to thousands of ppm concentrations. This provides an opportunity to construct a selective NH₃ sensor. The results of investigations of the sensing structure in NO₂ atmosphere are presented in Fig. 11.

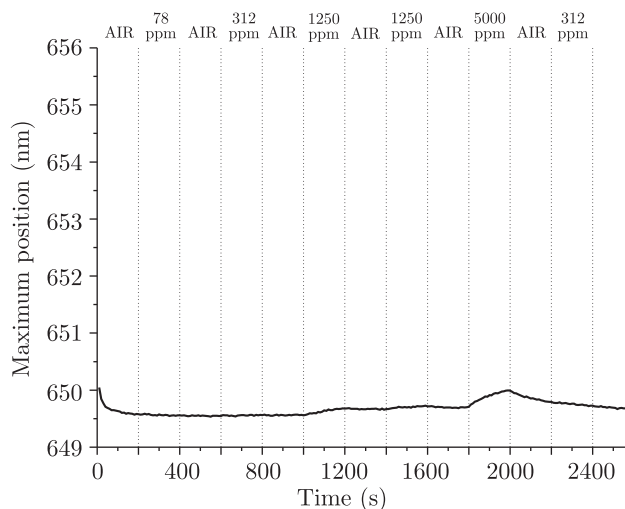

Fig. 11. Time characteristic of the P1N1 structure in NO₂ atmosphere

7. Conclusions and remarks

The presented optical polyaniline-based sensor can be an interesting solution for ammonia sensing under some specific conditions. The facility of constructing it and simplicity of operation is an interesting challenge in the group of gas sensors. The elaborated sensing element is of extremely small dimension. It is deposited on the end of a telecommunication optical fiber and its thickness is of the order of 1 μm.

Although the final product needs further investigations, the obtained results are very interesting. The researches carried out so far aim at finding the most appropriate structure with respect to the number and configuration of polyaniline and Nafion[®] layers. Further, complex investigations of these structures will allow us to determine the influence of other toxic gases, the influence of temperature, moisture or pressure on the sensor properties. Also the relationship between the concentration of ammonia and the observed spectral shift will be of interest in further research.

The characteristic feature of the described experiments is the fact that the measurements were taken in the atmosphere of synthetic air. Such a method imitates natural work conditions of natural environment sensors. Investigations of sensing properties of polyaniline layers presented in literature [11–14] were realized in an atmosphere of pure nitrogen. In our opinion on the base of such

investigations it will be difficult to predict the behaviours of sensing structures in the natural environment.

The results presented in this paper are quite original and have not been presented so far in the literature concerning the problem of optical gas sensors. The matter of optical gas sensors in Department of Optoelectronic at Silesia University of Technology in Gliwice (Poland) are developed from some years. The results of these investigations were the elaboration of optical dioxide nitrogen sensors based on the surface plasmon resonance phenomena [15–20].

Acknowledgements. The work was sponsored by the Polish State Committee for Scientific Research within the Grant 3 T11B 071 26.

REFERENCES

- [1] M. Ando, T. Kobayashi and M. Haruta, “Optical CO detection by use of CuO/Au composite films”, *Sensors and Actuators B* 24–25, 851–853 (1995).
- [2] Z. Gu and P. Liang, “Novel optical film sensor design based on p-polarized reflectance”, *Optics & Laser Technology* 36, 211–217 (2004).
- [3] K. Shinbo, M. Minagawa, H. Takasaka, K. Kato, F. Kaneko and T. Kawakami, “Electrical and luminescent properties due to gas adsorption in electroluminescent device of metal-free phthalocyanine”, *Colloids and Surfaces A: Physicochemical and Engineering Aspects* 198–200, 905–909 (2002).
- [4] A. Yimit, K. Itoh and M. Murabayashi, “Detection of ammonia in the ppt range based on a composite optical waveguide pH sensor”, *Sensors and Actuators B* 88, 239–245 (2003).
- [5] J. Homola, S.S. Yee and G. Gauglitz, “Surface plasmon resonance sensors: review”, *Sensors and Actuators B* 54, 3–15 (1999).
- [6] N.E. Agbor, J.P. Cresswell, M.C. Petty and A.P. Monkman, “An optical gas sensor based on polyaniline Langmuir-Blodgett films”, *Sensors and Actuators B* 41, 137–141 (1997).
- [7] G. Harsanyi, “Polymer films in sensor application”, Technomics Publishing Company, Lancaster, USA, 1995.
- [8] E.T. Kang, K.G. Neoh and K.L. Tan, “Polyniline: A polymer with many interesting intrinsic redox states”, *Prog. Polym. Sci.* 23, 277–324 (1998).
- [9] R.V. Plank, Y. Wei, N.J. DiNardo and J.M. Vohs, “Characterization of highly conducting, ultra-thin polyaniline films produced by evaporative deposition”, *Chemical Physics Letters* 263, 33–38 (1996).
- [10] M.E. Nicho, M. Trejo, A. Garcia-Valenzuela, J.M. Saniger, J. Palacios and H. Hu, “Polyaniline composite coatings interrogated by a nulling optical-transmittance bridge for sensing low concentrations of ammonia gas”, *Sensors and Actuators B* 76, 18–24 (2001).
- [11] P. Kiattibutr, L. Tarachiwin, L. Ruangchuay, A. Sirivat and J. Schwank, “Electrical conductivity responses of polyaniline films to SO₂-N₂ mixtures: effect of dopant type and doping level”, *Reactive and Functional Polymers* 53, 29–37 (2002).
- [12] www.dupont.com, www.atut.lublin.pl, www.permapure.com
- [13] H. Hu, M. Trejo, M.E. Nicho, J.M. Saniger and A. Garcia-Valenzuela, “Adsorption kinetics of optochemical NH₃ gas sensing with semiconductor polyaniline films”, *Sensors and Actuators B* 82, 14–23 (2002).
- [14] S. Christie, E. Scorsone, K. Persaud and F. Kvasnik, “Remote detection of gaseous ammonia using the near infrared transmission properties of polyaniline”, *Sensors and Actuators B* 90, 163–169 (2003).
- [15] E. Maciak, Z. Opilski, T. Pustelny and J. Ignac-Nowicka, “Investigation of thin films of phthalocyanines in plasmon system for their application in NO₂ sensors” *Molecular and Quantum Acoustics XXIII*, 111–122 (2002).
- [16] J. Ignac-Nowicka, T. Pustelny, E. Maciak, Z. Opilski, W. Jakubik and M. Urbanczyk, “Examination of thin films of phthalocyanines in plasmon system for their application in NO₂ sensors” *Optical Engineering* 42 (10), 2978–2986 (2003).
- [17] T. Pustelny, J. Ignac-Nowicka and Z. Opilski, “Experimental investigations of thin metalphthalocyanine layers CuPc, PbPc, NiPc by plasmon resonance method to be applied in NO₂”, *Optica Applicata XXXIV* (2), 249–264 (2004).
- [18] T. Pustelny, J. Ignac-Nowicka, J. Jarzabek and A. Burian, “Optical investigations concerning layered metalphthalocyanine nanostructures affected by NO₂”, *Optica Applicata* 3–4, 98–110 (2004).
- [19] T. Pustelny, J. Ignac-Nowicka and Z. Opilski, “Optical investigations on layered metalphthalocyanine nanostructures affected by NO₂ applying the surface plasmon resonance method”, *Optica Applicata* 3–4, 147–158 (2004).
- [20] T. Pustelny and J. Nowicka, “Investigation of thin sensor layers of ethalptoalocyanines in sensors of toxic gasses”, *Molecular and Quantum Acoustics* 25, 201–212 (2004).