

Biosensors for bioanalytical applications

D.G. PIJANOWSKA and W. TORBICZ*

Institute of Biocybernetics and Biomedical Engineering, Polish Academy of Sciences, 4 Trojdena Str., 02-109 Warsaw, Poland

Abstract. Biosensors are a crucial part of most of bioanalytical diagnostic devices and systems. Due to semiconductor technologies, a great progress in diminution of costs and miniaturisation as well as an increased reliability of these devices was achieved. Application of molecular and biological techniques in the detection process has contributed to a real increase in sensitivity, selectivity, the detection limit and the number of analytes to be detected. Different transducers of chemical parameters into electrical output signals are applied in these devices. Electrochemical principles, both potentiometric and amperometric, are opted for due to their simplicity of application and extremely low costs of such biosensors. Ion sensitive field effect transistors (ISFETs) may be easily integrated into the required electronics, resulting in their miniaturisation. Further miniaturisation may be attained by development of miniaturised total analytical systems (μ TAS). To ensure competitive parameters of these biosensors, optimal methods of immobilisation of biochemical receptors (ionophores, enzymes, antibodies, etc.) should be developed. A review of the work by the authors related to these problems is presented in the article.

Key words: micro (bio)chemical sensors, biosensors, micro analytical systems, lab-on-a-chip, immobilisation of bioreceptors.

1. Introduction

Nowadays, there are many analytical methods that can be used for determination of a vast number of biochemical analytes. However, they require well-equipped laboratories and specialised staff to operate the instruments. A modern analytical tool for biomedical applications should satisfy several requirements, such as minimisation of the sample and reagent volume, high selectivity for the analyte and a potential for acceptance by non-professional users. The most crucial part of these systems is the detection unit – the array of chemical and/or biochemical sensors.

Semiconductor technology gives an opportunity to satisfy these requirements in respect to both the sensing and the signal processing. Moreover, development of durable, small-size and low cost sensors for domestic use and implantation could be possible with this technology. An amazing feature of such sensors is their compatibility for integration with the required electronics, to create a micro analytical system. A very important group of chemical sensors are the ion sensitive field effect transistors (ISFETs) for detection of biologically relevant ions, such as hydrogen (pH), potassium, sodium, calcium and ammonium.

To measure the concentration of the uncharged biochemical molecules, e.g. urea, glucose, triglycerides, creatinine, pesticides etc., directly undetectable, enzymatic reactions may be used to produce substances detectable by the sensor, e.g. hydrogen, hydroxyl or ammonium ions. The substance to be measured (analyte) by the enzymatic biosensor may be (i) a substrate (e.g. urea, glucose...), (ii) an agent affecting the activity of the enzyme catalysing the substrate of a known concentration (e.g. pesticides, heavy metal ions), or (iii) an agent (immune molecules) linked to a defined enzyme, catalysing reaction of the corresponding substrate. To construct such biosen-

sor, the enzymes should be attached to the sensing surface of the basic sensor (transducer). Other bioreceptors, such as antigens, antibodies, DNA fragments, cells and tissues, may also be used.

In the 70-ties of the last century, miniaturised semiconductor chemical sensors and biosensors were proposed [1,2]. Rapid progress of semiconductor micromachining, made in the 1980s, became the basis for integration of very small functional units into microsystems in the 1990s. This integration initiated new trends in the biosensor technology, named micro total analytical systems (μ TAS) or the lab-on-a-chip, combining different functional blocks, in which micro reactors and biosensors are employed for the analyte detection [3]. Nowadays, in order to improve functionality of these micro analytical systems, they are often made as a hybrid, from various parts and technologies.

The (bio)chemical sensors are crucial parts of the micro analytical systems due to their sensitivity, selectivity, lifetime and often response time. Therefore, an essential step in the biosensor preparation process is immobilisation of bioreceptors onto the surface of transducers or microreactors.

In this paper, our research on development of electrochemical type biosensors for biomedical applications, emphasizing the bioreceptor immobilisation and implementation into microsystems, is presented.

2. Basic transducers for chemically sensitive devices

Transducers for biosensors manufactured with employment of semiconductor technologies may be of electrochemical (potentiometric, amperometric, conductometric), mass (bulk acoustic wave – micro-balance, surface acoustic wave), optoelectronic, colorimetric or thermoelectric types. The most popular trans-

*e-mail: wtorbicz@ibib.waw.pl

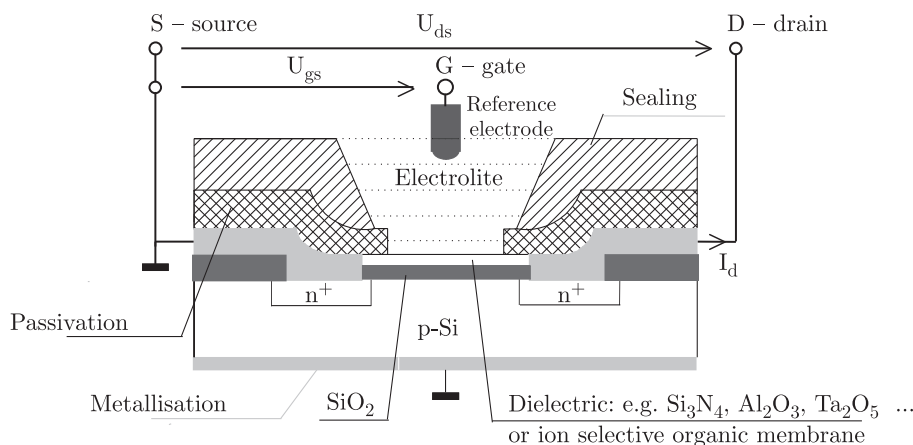

Fig. 1. Basic structure of Front Side Contact Ion Sensitive Field Effect Transistor – FSC ISFET

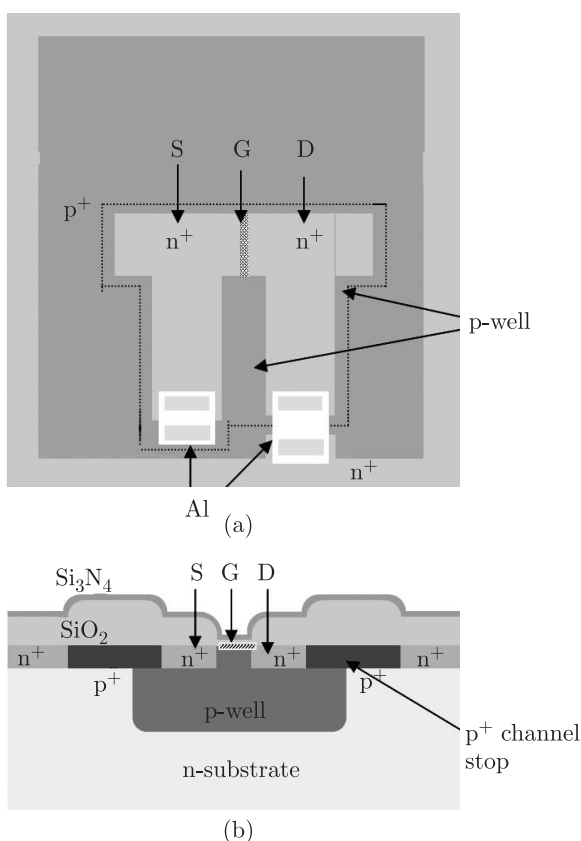

Fig. 2. The p-well FSC ISFET: the layout (a) and the cross-section (b)

ducers are ion sensitive field effect transistors (ISFETs), solid state electrodes, Clark electrodes and chemically sensitive resistors.

Since electrochemical sensors do not require sophisticated equipment for the signal processing, and they are relatively easily calibrated; this technique is also regarded as cheap, with a potential for wide use. The potentiometric type of biosensors, based on the ion sensitive field effect transistors (ISFETs), has here been mainly dealt with. ISFETs' structures have been developed at our Institute in cooperation with the Institute of

Electron Technology (ITE), Warsaw and manufactured at the ITE [4–6].

The overall ISFET structure (Fig. 1) has been formed at the front side of the wafer (3", p-type, <100> oriented, 5-8 Ωcm and 380 μm thick) by means of modified CMOS LOCOS process (CMOS – Complementary Metal Oxide Semiconductor; LOCOS – Locally Oxidised Semiconductor). Consecutive lithography and ion implantation steps were used to create specific areas of the device: n^+ - to dope source (S) and drain (D) areas; n^+ of lower doping – to define channels and p^+ - to form the channel stoppers. Such a configuration is called the Front Side Contact ISFET (FSC ISFET).

Silicon dioxide and silicon nitride double layer was used as gate insulators. The top gate layer, made of silicon nitride, may be used as a chemically sensitive membrane for the hydrogen ion (pH) detection. The output signal from ISFETs is the gate potential change resulting from alteration of concentration of the hydrogen ions. Dielectrics, such as oxides of transition metals (e.g. Ta_2O_5 , ZrO_2 , HfO_2 , TiO_2) and Al_2O_3 , and boron nitride (BN), are also sensitive to hydrogen ions and may be used as chemically sensitive membranes of pH-ISTETs [4,5,7–11]. Whole the structure outside the gate window is passivated with glass or silicon nitride.

To improve the electrical insulation, the ISFET design was modified by implementation of a p-well into semiconductor chip (Fig. 2) [6]. Thanks to the implementation of contiguous transistors in the separated p-type wells, a very good electrical insulation between these transistors was obtained. This construction can be used to build-up a micro sensor array consisting of a series of ISFETs. It should be mentioned that the p-well FSC ISFET was made on the n-type substrate.

Both FSC ISFETs approaches impose special requirements for the chip assembling. The bonding pads and the wires should be carefully protected with resin against contact with the analysed solution.

An output signal of ISFETs results from alteration of the gate potential due to changes of the membrane/electrolyte interfacial potential caused by changes in concentration of the

hydrogen ions. The quantitative description of properties of pH-ISFETs with oxides and nitrides as gate materials is based on the binding site theory of the membrane surface and on the analysis of the electric double layer (EDL) structure at the electrolyte/membrane interface. In this theory, joint effects of hydrogen ion exchange and physical and chemical adsorptions of anions, cations and neutral molecules, including water molecules (surface hydration), are studied. An extended model of the pH-ISFET/electrolyte system determining the measured properties of the system [4,5,12,13] has been developed. The dependence of the gate potential changes (ΔV_g) vs. the negative decimal logarithm of the hydrogen ions concentration (pH), which corresponds to the Nernst equation for the ion selective electrodes, has been shown to be non-linear. For an electrolyte containing monovalent ions, only the smallest value of sensitivity s , defined as the ratio $\Delta V_g/pH$, appears in the point of zero charge (for uncharged membrane surface) is equal to:

$$s = -\frac{2.3RT}{F} \frac{1}{1 + RT/F\psi_T}, \quad (1)$$

where

$$\begin{aligned} \psi_T &= qN_s\delta \frac{1}{C_T}, \\ \frac{1}{C_T} &= \frac{1}{C_S} + \frac{1}{F} \left(\frac{RT}{2\varepsilon_w c} \right)^{1/2}, \\ \delta &= 2 \left(\frac{K_a}{K_b} \right)^{1/2}, \end{aligned} \quad (2)$$

R – gas constant, T – temperature in Kelvin, F – Faraday constant, q – elementary charge, N_s – binding site density of the membrane surface, ψ_T – parameter in volts, C_T – equivalent capacitance of serially connected tight (C_S) and defused parts of the EDL, ε_w – water dielectric constant, c – total concentration of all monovalent cations of the electrolyte, K_a and K_b – acidic and basic reaction equilibrium constants, respectively.

The first factor of Eq. (1) determines the Nernstian sensitivity (59.2 mV/pH at room temperature). As a rule, the pH-ISFET sensitivity is under the Nernstian value for inorganic gate membranes. To obtain a nearly linear characteristic with a sensitivity close to the Nernstian value, binding site density N_s should satisfy the condition:

$$N_s \gg C_S RT / \delta q F. \quad (3)$$

A special temperature and gas treatments are needed to fulfil this requirement [4,13].

The ISFET output signal may be measured by measuring the changes of transistor threshold voltage ΔU_T .

$$U_T = E_{ref} + \varphi_{me} + \phi_{is} - \frac{Q_i}{C_i} - \frac{Q_B}{C_i} + 2\phi_F, \quad (4)$$

where: E_{ref} – reference electrode potential, C_i – capacitance of the gate insulation layer, Q_{ss} – total electrical charge of the gate insulation layer, Q_B – semiconductor bulk electrical charge, φ_{me} – membrane/electrolyte interface potential. This

potential may be determined by Eisenman-Nikolski equation:

$$\varphi_{me} = E^0 \pm 2.3 \frac{RT}{z_i F} \log \left(a_i + \sum_{j=1}^n K_{ij} a_j^{z_i/z_j} \right), \quad (5)$$

where E^0 – electrode standard potential, a_i – primary ion (to be measured) activity (approximately – concentration), a_j – activity of interfering ion, K_{ij} – selectivity coefficient, z_j – valence of the primary ion.

For constant values of drain current I_d and drain-source voltage U_{ds} (Fig. 1), changes of gate voltage ΔV_g depend on pH , according to equation:

$$\Delta V_g = \Delta \varphi_{me} = k \Delta pH \quad (6)$$

The electronic circuit satisfying these requirements may be designed as a common source circuit (output signal: $\Delta U_{gs} = k \Delta pH$), a source follower ($\Delta U_s = k \Delta pH$) and a common drain circuit ($\Delta U_d = k \Delta pH$).

Electronic circuits for supplying ISTETs and processing of the interfacial potential with the output signal have been developed [5,14,15]. One of these electronic circuits was integrated into VLSI circuit in cooperation with Chung Yuan Christian University, Chung Li, Taiwan [16,17].

A typical ISFET response to pH changes of electrolyte is shown in Fig. 3. Hysteresis of this characteristic can be noted. Many very complex physico-chemical phenomena determine such dependence. Certain trials to explain it have been undertaken [5,13]. The main underlying factors seem to be associated with a shift of the mobile electrical charges in the semiconductor structure, including the gate membrane, and alteration of properties of the binding sites during the up and down pH cycling.

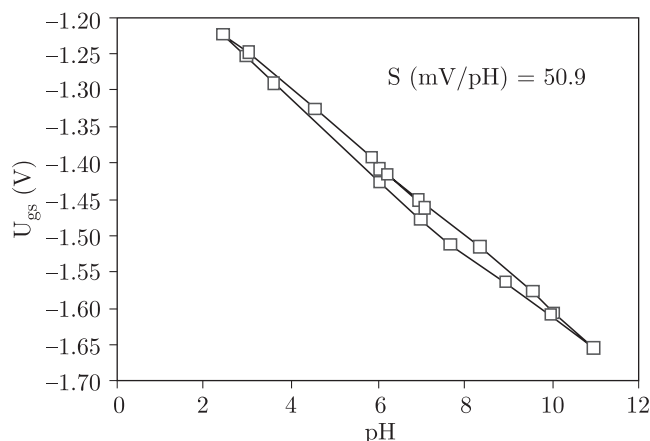

Fig. 3. p-well-ISFET response to pH

3. Functionalisation of biosensors and bioreactors surfaces

To obtain particular properties of the chemically sensitive membrane, the gate surface can be chemically modified. Sensors for different ions and neutral molecules of the transistor type (ChemFETs) may be realised by deposition of polymeric

membranes onto the top of the gate insulator layer. These membranes may be used as matrices for immobilisation of: (1) ligands (ionophores) that form complexes with ions to be detected, (2) receptors, e.g. antibodies and (3) catalysts (e.g. enzymes). A common material used for manufacturing of the matrices is polyvinyl chloride (PVC), attached physically to the transducer. Enzymatic ChemFETs are named EnFETs.

Deposition of hydrophobic PVC membrane directly onto the ISFET gate hydrophilic insulator, both SiO_2 and Si^3N^4 , has some drawbacks referring to disturbances of the output signal due to (1) the ill-defined interface between the membrane and the gate insulator because of a poor adhesion, (2) seepage of water through the membrane which impairs this adhesion, diminishing the lifetime, and (3) penetration of carbon dioxide (acidic agent) through the membrane. To overcome these drawbacks, certain attempts, including (1) modifications of PVC membrane with certain agents, (2) application of new polymers with reactive groups enabling their chemical attachment to the gate surface, (3) modifications of the inorganic gate surface, and (4) optimisation of the deposition processes, have been made [5,18–20].

Works carried out by many researchers, including our group, have shown that deposition of poly(hydroxyethyl methacrylate) hydrogel – polyHEMA – on the gate surface modified with 3-(trimethoxysilyl)propyl methacrylate improves properties of the ChemFETs. Prior to this procedure, the surface should be hydrated, to create silanol groups (SiOH), and then silanised, to produce reactive groups for binding of the polymers or the receptors. To deposit this hydrogel, a liquid HEMA monomer mixture was spun on the wafer and then photochemically polymerised by UV-irradiation. In effect, a coat of polyHEMA covalently bound to the substrate was obtained [5,18,20]:

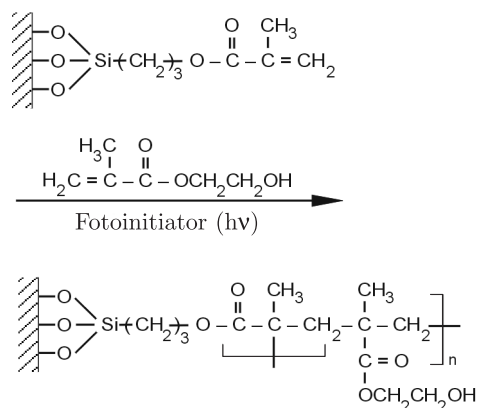

Considering another membrane matrix material, polysiloxanes (e.g. Siloprene) have been shown to have adequate biocompatibility and an increased adhesion to the inorganic gate surface, and may be processed and shaped by photolithography, so these polymers are highly appropriate for manufacture of sensing membranes and immobilisation of different receptors (ionophores, enzymes, antibodies ...) [21–23]. The immobilisation procedures should ensure the activity of the immobilised receptors.

An important part of the electronic circuit for electrochemical measurement of concentration is the reference electrode (Fig. 1). Many trials have been undertaken to miniaturise it. One of them is development of such an electrode based on the ChemFET structure. The reference FET type electrode (RefFET) should have a close to zero sensitivity. According to eq. (1), this corresponds to a near to zero value of binding site density N_s of the gate membrane surface. To attain this goal, a polyHEMA gel layer may be deposited on the ISFET structure as the top buffering layer [20,21].

A special attention should be paid to immobilisation of enzymes, to preserve their high activity and the life time of biosensors. There are three basic groups of methods of enzyme immobilisation: physical, chemical and mixed. The most common methods for enzyme immobilisation are: (1) physical adsorption on matrix and entrapment within the polymeric network, (2) entrapment in gel matrix, (3) crosslinking, using a multi-functional crosslinking agent, and (4) covalent binding to the matrix or the sensor gate surface. In the two latter cases, glutaraldehyde (GA) is used as the bi-functional agent to crosslink the enzyme molecules through their amine groups (NH_2) or to bind the enzyme to the gate membrane with NH_2 groups (binding sites) that appear on the surface of the Si^3N^4 gate insulator or may be formed on the membrane by aminosilane treatment of its surface (Fig. 4). Bovine serum albumin (BSA) is often used as ballast protein for the crosslinking reaction with GA. Many enzymes are very labile and sensitive to some inhibitors, since they have an unstable structure. To prevent their full or partial inactivation during the immobilisation process, it is necessary to use special chemical substances (substrates, chelates, thiols etc.). To immobilise an enzyme, selection of a proper silane and other reagents and optimisation of this process is required [5,19,23–25].

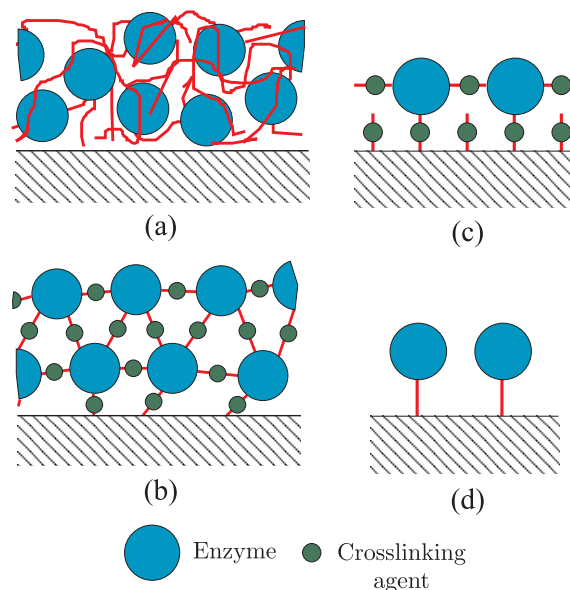

Fig. 4. Methods of enzyme immobilisation: a) entrapment in gel matrix, b) crosslinking with multi-functional agent, c), d) covalent bond with and without bi-functional agent respectively

Table 1
 Basic data of ion selective ChemFETs developed at the IBBE PAS

No. Ion	Membrane	Ionophore	Sensitivity (mV/pMe)	Linear range (pMe)	Selectivity (log K_{ij})
1 K ⁺	PVC	valinomycine	ca 58	0.11 ... 5.5	-4 (Na ⁺), -5 (H ⁺)
2 K ⁺	PVC	t-butylnaphto-15-crown-5 ether	50 ... 55	0.1 ... 4.5	-3.5 (Na ⁺), -4 (Ca ²⁺)
3 Na ⁺	PVC	ETH 227	50-60	0.1-0.4	-1.7 (K ⁺), 0.4 (Li ⁺), -0.7 (Ca ²⁺)
4 Na ⁺	PVC	ETH 2120	50-60	0.1-0.4	-1.5 (K ⁺), -1.2 (Li ⁺), -2.9 (Ca ²⁺)
5 Na ⁺	PVC and Siloprene	bis(phenylbenzo)-13-azocorwn-5 ether	54-56	0,1-0.35	-1.5 (K ⁺), -1.5 (Li ⁺), -3.0 (Ca ²⁺)
6 Ca ²⁺	PVC	ETH 1001	ca 29	1-8	-5 (Na ⁺), -5 (K ⁺)
7 NH ₄ ⁺	PVC	nonactine	51-58	1-4	-0.8 (K ⁺), -2.8 (Na ⁺), -3.20 (Ca ²⁺)
8 NH ₄ ⁺	Siloprene	nonactine	48-55	1-4	-0.8 (K ⁺), -2.8 (Na ⁺), -3.20 (Ca ²⁺)

 Table 2
 Enzymatic reaction utilised in biosensors

No.	Analyte	Enzymatic reaction	Detection
1	Glucose	Glucose + O ₂ + H ₂ O $\xrightarrow{\text{Glucose oxidase}}$ Gluconate + H ⁺ + H ₂ O ₂	pH, O ₂
2	Urea	CO(NH ₂) ₂ + 3H ₂ O $\xrightarrow{\text{Urease}}$ CO ₂ + 2NH ₄ ⁺ + 2OH ⁻	pH, pNH ₄
3	Triglycerides	Triglycerides + 3H ₂ O $\xrightarrow{\text{Lipase}}$ Glycerol + 3 Fatty acids	pH
4	Acetylcholine (ACH)	CH ₃ COO(CH ₂) ₂ N ⁺ (CH ₃) ₃ + H ₂ O $\xrightarrow{\text{ACHEsterase}}$ HO(CH ₂) ₂ N ⁺ (CH ₃) ₃ + CH ₃ COO ⁻ + H ⁺	pH
5	Inhibitors: pesticides, heavy metal ions	CH ₃ COOO(CH ₂) ₂ N ⁺ (CH ₃) ₃ + H ₂ O $\xrightarrow{\text{Inhibitor} \rightarrow \text{ACHEsterase}}$ HO(CH ₂) ₂ N ⁺ (CH ₃) ₃ + CH ₃ COO ⁻ + H ⁺	pH
6	Butyrlcholine (BCH)	CH ₃ (CH ₂) ₂ N ⁺ (CH ₃) ₃ + H ₂ O $\xrightarrow{\text{BCHesterase}}$ HO(CH ₂) ₂ N ⁺ (CH ₃) ₃ + CH ₃ (CH ₂) ₂ COO + H ⁺	pH
7	Creatynine	Creatynine + H ₂ O $\xrightarrow{\text{Creatynine deiminase}}$ NH ₄ ⁺ + N - methylaydantonine	pNH ₄

One of the most important blocks of micro total analysis systems (μ TAS) is the microreactor used for the sample treatment, often with employment of an enzymatic reaction. To construct such a system, similar to the presented above but much more complex, technological processes should be developed to immobilise enzymes onto the micro reactor walls or glass or polymeric beads, used as batch, if a column type micro reactor is taken into account.

4. Ion selective electrodes

As it was mentioned above, the ionometry is of a great importance for analytical diagnostics. A family of ChemFET type sensors for measurement of the concentration of the light metal ions (K⁺, Na⁺, Ca⁺⁺) and ammonium ions (NH₄⁺) have been developed. PVC and its modifications and polysiloxanes, mainly Silopren, were used as the membrane matrix. Adequate ionophores were immobilised within these membranes. The basic parameters for the ChemFETs are presented in Table 1 [4,21-23,25].

In the case of the sodium sensitive ChemFETs, presented in Table 1, No. 5, the ion-selective membrane contained new ionophore, bis(phenylbenzo)-13-azocorwn-5 ether, synthesized at the Chemical Department of Gdansk University of Technology [23]. The ionophore was of an increased lipophilicity, which results in a low leakage rate of the ionophore from the membrane. This results in a prolonged lifetime of the sensor.

ChemFET type sensors were constructed as deepsticks and catheter type probes, and were tested both in the deep mode and in the flow-through system. The catheter type pH probe was used for the *in vivo* monitoring of pH during the peritoneal dialysis in rats [26].

5. Biosensors

As it has been presented in paragraph 3, enzymatic biosensors of the EnFET type have a sandwich-like structure (Fig. 5). An operation of the biosensor may be shortly described as follows: the analyte diffuses from the solution into the enzymatic membranes and, due to one of reaction listed in Table 2, the hydrogen or ammonium ions are produced that diffuse into the ion selective membrane controlling the threshold voltage of the transistor which determines the output signal.

It should be pointed out that to optimise the parameters of the biosensor, the method and conditions of immobilisation of enzyme should be developed for each enzyme individually.

5.1. Urea biosensors. The urea concentration in serum provides information on the kidney function. Therefore, it is relevant for renal disease diagnostics (evaluation of kidney efficiency) and therapy. In the latter case, the urea concentration is an indicator for the control of the dialysis and hemodialysis therapy. As it results from the enzymatic reaction, Table 2 No. 2, changes in concentration of products – ammonia and bicarbonate as well as bicarbonate, carbonate and hydrogen ions

remaining in equilibrium with them – are proportional to the concentration of urea in the sample solution. In our research, detection of pH and pNH₄ were applied for determination of urea.

In our development of EnFET type urea biosensors, based on the pH detection, enzymatic membranes were prepared using three methods: (1) entrapment of urease in carboxylated polyvinyl chloride (COOHPVC membrane, adsorbed on the silicon nitride gate, (2) covalent binding of urease to the COOHPVC matrix, and (3) direct covalent binding of urease to the silicon nitride through glutaraldehyde (GA) [5,21,24,25,27]. In the most frequently used methods, taken from literature, the silicon nitride surface is treated first with aminopropyltriethoxysilane (APTS) and then enzyme is coupled through glutaraldehyde to the functionalised silicon nitride surface. The third method (developed by the authors) is based on the Schiff's base formation between the amino groups on the silicon nitride surface and the enzyme via GA. The scheme of the Schiff's base formation (Silicon nitride-GA-Enzyme) is as follows:

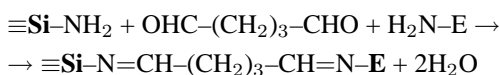

where Si-NH₂ – amino type groups on the hydrated surface of the gate silicon nitride and E – enzyme [5,24].

A typical dynamic response and corresponding calibration curve of the biosensor in 10 mM phosphate buffer are shown in Fig. 6. The sensitivity and linear range of the biosensors depend on pH and capacity of the buffer solution. The linear range of characteristic may be shifted towards a higher urea concentration by increasing the buffer capacity. As a consequence of the effect of the buffer solution pH and concentration on the biosensor response, a special procedure of the sample preparation is necessary. This means that for accurate measurements, the actual samples should be prepared by dilution in the same solution like that used for the calibration. The response time of the biosensor was about 80 s and the lifetime about 50 days [5,24,25].

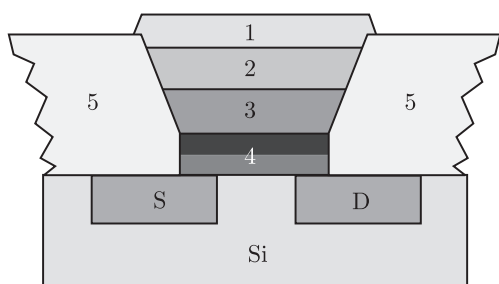

- 1: enzymatic membrane
- 2: ion selective membrane
- 3: polyHEMA hydrogel layer
- 4: gate layers:
 - silicon nitride
 - silicon oxide
- 5: encapsulation

Fig. 5. Structure of enzymatic biosensors

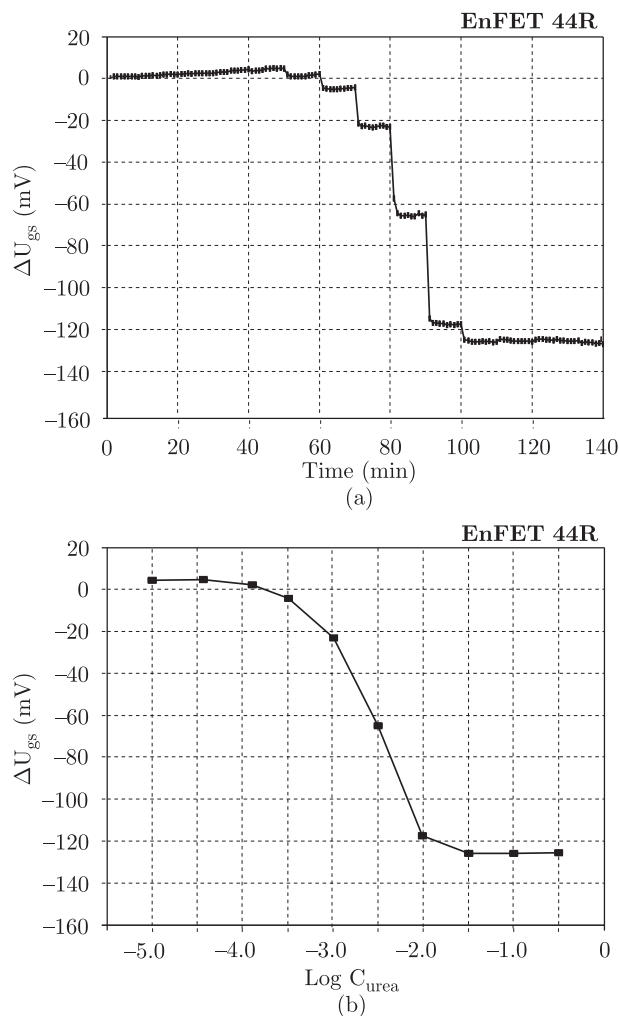

Fig. 6. Typical dynamic response (a) and calibration curve (b) for urea-EnFET of the type 3 in phosphate buffers: 10 mM, 0.1 M NaCl and at pH 6.0

In urea EnFETs, based on detection of the ammonium ions, the enzymatic membrane was deposited on the gate window of ammonium ion selective ChemFET presented in Table 1., No. 8. The enzyme was immobilised by crosslinking with glutaraldehyde [23,24]. The typical characteristic of the urea EnFET is presented in Fig. 7. The sensitivity of this type of biosensor varied from 40 to 43 mV/dec, while the linear range was 10⁻³ to 10⁻¹. Adhesion of the enzymatic membrane to the Siloprene membrane was good enough to perform stable measurements for about 15 days. After that time, the membrane could be replaced with a new enzymatic membrane [21, 25].

The biosensors were tested in biological fluids, such as dialysate and blood serum [5,27,28]. The measurements were performed in the flow-through system. The accuracy of the measurements of urea in dialysate as well as in blood serum by EnFET was better than 10% with respect to the reference spectrophotometric method which makes the EnFETs acceptable for clinical use.

In the case of measurement of the urea concentration by biosensor with ammonium ion detection, interference with the

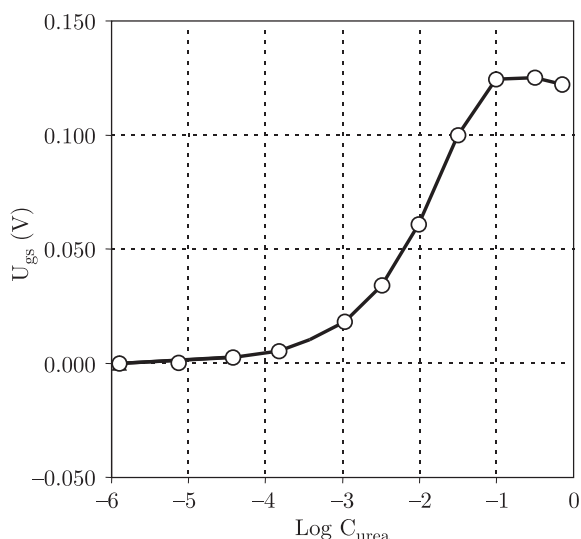

Fig. 7. Calibration curves of the urea EnFET with ammonium ion detection in 0.1 M orthophosphate buffers at pH 6

ammonium ions present in biological samples and the ammonium ions being a product of the enzymatic reaction may be noted. To minimise this interference, a bienzymatic sensor with membranes of urease and glutamate dehydrogenase (GLDH), crosslinked with bovine serum albumin by glutaraldehyde, was developed [29]. The outer GLDH membrane acts as a blocking layer for ammonium ions coming from the solution.

5.2. Other biosensors

Triglycerides biosensors. An increased level of triglycerides is an indirect coronary disease risk factor. In practice, to determine triglycerides, the spectrophotometric methods are commonly used. Due to their complexity, such measurements are expensive and may be performed in analytical laboratories. To diminish costs of these measurements, a new biosensor based on the reaction given in Table 2, No. 3 was proposed [30,31]. The production of fatty acids by means of the lipolysis reaction under the specific reaction conditions may result in pH-changes which is a basis for determination of triglycerides.

The main problem, related to this method, is optimisation of the conditions of the lipolysis reaction. The effect of certain reagents, such as activators (calcium chloride), and emulgators (cholic acid, detergents) operating in aqueous and alcoholic solutions on the reaction was examined. As the triglyceride standards for the biosensor calibration, trioleine, triacetine and tributyrine were used. Due to the fact that the lipase activity can be significantly reduced in alcoholic and detergent solutions, the reactions of lipolysis and dissociation of fatty acids should be separated. The separation of the two reactions may be realised e.g. in a micro analytical system consisting of the separated reaction cell, mixer and measuring cell.

Glucose biosensors. Determination of the glucose concentration in blood is a basic test in the diagnosis and therapy of diabetes. For measurements of glucose, spectrophotometric and electrochemical (amperometric and potentiometric) meth-

ods are commonly used. Mainly, the methods are based on hydrolysis of glucose in the enzymatic reaction catalysed by glucose oxidase (GOD) (Table 2. No.1). Some preliminary works on miniaturised glucose sensors, both potentiometric (EnFET type) and amperometric were carried out by our group too [32]. The works related to the first type of biosensors were directed to the optimisation of physical and chemical immobilisation of GOD onto the silicon nitride gate surface of ISFETs with the use of glutaraldehyde and bovine serum albumin (BSA), and sodium alginate [19]. The amperometric biosensors were of the flow-through type, in which GOD was delivered to the sample solution in the measuring cell through the semi-permeable membrane from the outside container [33].

Pesticides biosensors. Pesticides negatively influence immunoprotection of human organism because of the inhibition of different enzymes, in particular, acetylcholine esterase (AChE). Since pesticides are widely used in agriculture, control of these kinds of pollutants cumulated in water and in soil becomes of a key importance for health. Basing on the enzymatic reactions given in Table 2, No. 4, 5 and 6, cheap, fast and very sensitive biosensors for determination of organophosphorus pesticides, based on detection of pH, may be developed [19,34]. In these biosensors, pesticides type analytes inhibit AChE influencing its activity. The pesticides, that inhibit the enzyme, can be determined through measurement of the pH change resulting from the enzymatic reaction at the constant concentration of the substrate (acetylcholine or butylcholine). The developed biosensors were applied for determination of organophosphorus pesticides in juices of some vegetables. The heavy metal ions (Co^{2+} , Cu^{2+} , Hg^{2+} , Pb^{2+}) are known to inhibit BChE and urease, so these enzymes may be applied in construction of biosensors for determining these ions, e.g. in juices and blood serum [35,36].

Immune biosensors. Due to application of immunoreactions in biosensors, a very high specificity, allowing determination of the analyte concentration in multi-analyte fluids, can be obtained. The reaction between the antibody and antigen (analyte) is performed on a solid state surface with immobilised immunoreagents. In general, immunosensors are based on potentiometric, amperometric and optical principles of operation.

In our research group, research on immunosensors has been oriented towards investigation of immobilisation methods of immunoreagents as well as quantitative and qualitative determination of human immunoglobulin (hIgG) by means of the pH-metric method [37]. In this case, pH-ISFET were used as potentiometric transducers, and the immunoparticles anti-idiotype goat antibodies) labelled with urease were immobilised onto ISFET gate. Measurement of the pH changes, as a function of concentration of h IgG, in the sample solution by means of pH-ISFET was performed. The sensitivity of the biosensor being a function of immunocomplexes h IgG + IgG-urease concentration was 39.7 mV/dec. The concentration of immunocomplexes is directly proportional to the concentration of h IgG in the sample.

Miscellaneous biosensors. Works on development of biosensors for detection of other analytes were started by our group recently. Phenylalanine biosensors, based on the po-

tentiometric detection of pH and the ammonium ions, are required for a low cost diagnosis of phenylketonuria, a very serious metabolic disease [38]. A large group of biochemical compounds, including pharmaceutical products (drugs and toxins), may be determined using the amperometric biosensors. A technological platform for manufacturing such sensors has been prepared.

6. Micro analytical systems

The micro analytical system usually consists of several units that are responsible for different functions of the system, such as the sample transport unit, unit for reagent mixing (micromixer), unit for the sample chemical treatment (also called microreactor) and the detection unit. The unit of the sample transport is made up of microfluidic systems actuated and controlled by micropumps and microvalves. The fabrication process of these units is mainly related to the micro electromechanical system (MEMS) technology. Certain preliminary works on these units have been started at the Institute of Electron Technology in cooperation with our group.

As it was mentioned above, the detection functions of the system are mainly realised through biosensors and in some cases through microreactors. Therefore, in our research, the object of the primary interest has been the development of the detection unit, described in previous sections, and secondary, the sample treatment unit (microreactor). Some other works on the flow-through chemical sensors are described in section 6.2 below.

6.1. Microreactors. Four types of microreactors were developed [39–41]. The first two of them were of a batch type, filled with the enzyme (urease) immobilised on the porous glass or polymeric beads. The first type was fabricated in the form of a flow-through column (batch type) of 100 μl volume, made of Perspex with an inlet and an outlet protected by Nylon® net (Dupont) (Fig. 8a).

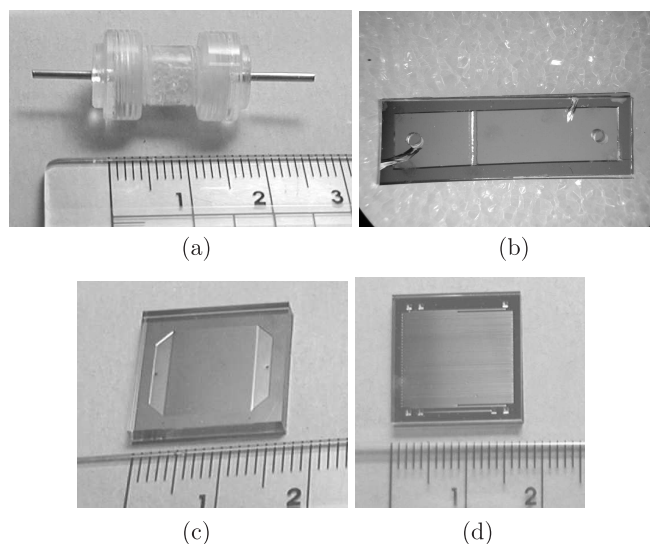

Fig. 8. View of the column type microreactor implemented in Perspex packed with glass beads with immobilised urease (a) and column with batch (b), lamella (c) and meander (d) type microreactors implemented in silicon

Surfaces of the glass beads (PG 1000–120, Sigma) of 80–120 μm diameter and 100 nm size pores were hydrated and then silanised with glycidoxypolytriethoxysilane (GOPS) as well as aminopropyltriethoxysilane (APTS) followed by the glutaraldehyde (GA) treatment. Two types of the polymeric beads were tested: 200 μm diameter, 100 nm size pores polyacrylamide with epoxy rings (EUPERGIT) and the reduced polyacrylonitrile (PAN) developed by our group. For modification of the PAN beads GA were used.

In the last step, an enzymatic layer (urease) was deposited onto the chemically modified supports. In all the cases, for the enzyme deposition, an enzyme solution containing 25 mg of the urease in 1 ml of the phosphate buffer was used besides the EUPERGIT beads. To obtain covalent binding of the enzyme to the substrate, the supports were exposed to the enzyme solution at room temperature overnight. The EUPERGIT beads were enzymatically modified according to the producer recommendations [42].

The fabrication technology of the silicon microreactors applied processes consisting only of two mask levels. It was performed on the two-side polished silicon wafer of $\langle 100 \rangle$ crystal orientation. In the first step, anisotropic etchant (KOH) was used to make an inlet and an outlet; both in the form of square holes. Next, cavities of the micro reactors of different shapes were lithographically created. The batch type micro reactor (Fig. 8b) was etched as a cuboid cell ($6 \times 21 \times 0.22$ mm, volume 27 μl) divided by the 130 μm high threshold into two compartments with volume ratio 1:2. The third microreactor, called lamella (Fig. 8c), was made in the form of 62 parallel channels (10 mm long, 50 μm deep and 100 μm wide, volume 3 μl), with a common inlet and outlet, while the fourth microreactor (Fig. 8d) was made in the form of 1 m long meander -type single channel (50 μm deep and 100 μm wide, volume 5 μl).

Afterwards, the silicon wafer was anodically bonded to a Pyrex plate 2 mm thick. Finally, the silicon-glass sandwich was diced into chips.

To obtain the functional groups on the surface of the microchannels covered with a thin layer of native silicon oxide, their surfaces were chemically modified similarly to the processing the glass beads. The micro reactors were tested in a flow-through system where the flow was driven using a peristaltic pump. The hydrolysis reaction of urea, catalysed by the immobilised urease (see Table 2, No. 2), was analysed using the recording of the pH changes in the sample solution. Concentration of urea in the solution was changed by the standard addition method. Before the sample introduction into the measuring system, the micro reactors were rinsed with phosphate buffer solution. All measurements were taken at room temperature.

The comparison of the changes of the output signal in time for the batch type microreactors filled with glass-APTS, EUPERGIT, and PAN modified beads (Fig. 9a) as well as the lamella type silicon microreactors modified with APTS and GOPS microreactors (Fig. 9b) indicates that the most stable and the highest output signal was obtained for the batch type microreactors filled with urease immobilised onto the PAN beads.

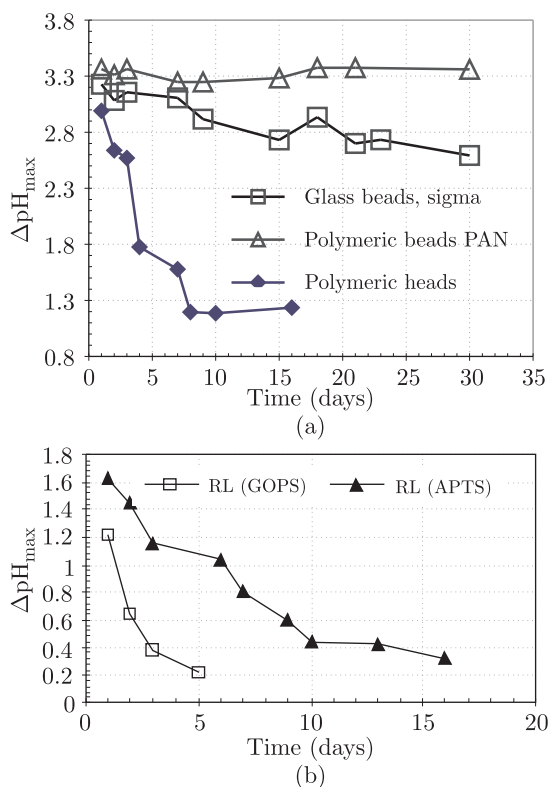

Fig. 9. Changes of the output signal ($\Delta\text{pH}_{\text{max}}$) in time for the batch type microreactors filled with: glass-APTS, EUPERGITand PAN modified beads (a) and lamella type silicon microreactors modified with GOPS and APTS, all with immobilised urease (b)

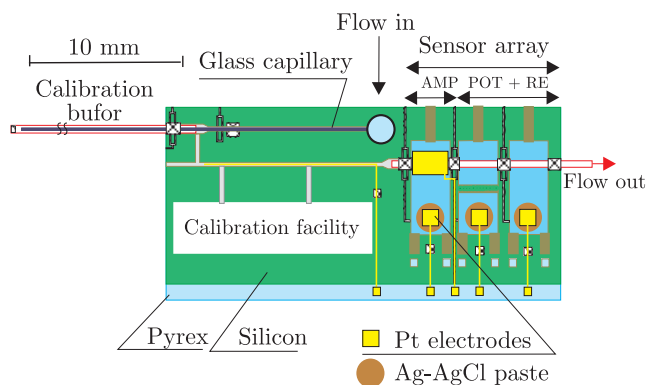

Fig. 10. Layout of an integrated flow-through system implemented in silicon

The most stable and the highest output signal was obtained for the batch type microreactors filled with urease immobilised onto the PAN beads. For the other types of microreactors, reduction of the output signals in time during the first days of their operations can be observed. This can be explained by the slow washing out of the non-attached molecules from the microreactors. After the initial time of their operation, the signals become stable at a low level.

6.2. Flow-through analytical microsystems. As it has been stated above, miniaturisation of the components of the chemical analysis systems leads to minimisation of the sample volume and reduction of the total assay time. There are several methods of integration of these components into one system: external connection of the microcomponent, hybrid technique and micromachining in silicon. Some of our joint works realised in cooperation with the MESA Research Institute, University of Twente can be found in [33,43]. Figure 10 presents an integrated flow-through system consisting of three electrodes: glucose (amperometric, with glucose oxidase – Table 2, No. 1), potassium (potentiometric, with valinomycin as the ionophore – Table 1, No. 1) and Ag/AgCl reference electrode, and the calibration block.

The biosensor sensitivity to glucose for the fixed sampling time (25 s) and a constant flow rate of 2 $\mu\text{l}/\text{min}$ was about 4.3 nA/mM and the sensitivity of the potentiometric electrode to potassium ions was in the range of 50–55 mV/dec. The system was tested with a microdialysis probe connected to its input.

7. Conclusions

Examples of miniaturised chemical and biochemical sensors and systems developed at the Institute of Biocybernetics and Biomedical Engineering PAS in cooperation with the Institute of Electron Technology and other research groups indicate that semiconductor and biochemical technologies, including micromachining, available to the Polish research teams, enable development of modern bioanalytical devices and systems applicable in medical diagnosis and environmental pollution monitoring. These works are in line with the trend of the leading world laboratories.

REFERENCES

- [1] P. Bergveld, "Development of ion-sensitive solid state device for neurophysiological measurement", *IEEE Trans. on Biomed. Eng.* BME-21, 70–71 (1970).
- [2] P. Bergveld and A. Sibbald, *Analytical and Biomedical Applications of Ion-selective Field-effect Transistors*, Amsterdam: Elsevier, 1988.
- [3] A. Manz, N. Graber, and H.M. Widmer, "Miniaturized total chemical analysis systems: a novel concept for chemical sensing", *Sens. Actuators B* 1(3), 244–248 (1990).
- [4] W. Torbic, *Theory and Properties of Field Effect Transistors as Chemical and Biochemical Sensors*, Wrocław: Ossolineum, 1988, (in Polish).
- [5] D.G. Pijanowska, *Analysis of Factors Determining Parameters of Ion Sensitive Field Effect Transistors as the Sensors of Biochemical Quantities*, IBIB PAN Works, No. 46, Warsaw, 1996.
- [6] B. Jaroszewicz, D. Tomaszewski, A. Kociubiński, M. Nikodem, P. Grabiec, D. Pijanowska, W. Torbic, and M. Chudy, "Design and process development of ion sensitive FET's", *Proc. of Conf. ELTE*, 214–215 (2004).
- [7] D. Sobczykńska and W. Torbic, "ZrO₂ gate pH sensitive field effect transistor", *Sens. Actuators* 6, 93–105 (1984).
- [8] D. Sobczykńska, W. Torbic, A. Olszyna, and W. Włosiński, "Borazon gate pH sensitive field effect transistor", *Analyt. Chim. Acta* 171, 357–361 (1985).

- [9] A. Olszyna, W. Włosiński, D. Sobczyńska, and W. Torbicz, "A study of borazone gate pH sensitive field effect transistors", *J. Crystals Growth* 82, 757–760 (1987).
- [10] W. Torbicz, "Oxides of the titanium family metals as membranes in pH ISFETs", *Lecture Notes of the ICB Seminar on Biomeasurements*, Jabłonna, 3, 328–344 (1990).
- [11] D. Pijanowska and W. Torbicz, "Long-term stability of Si₃N₄, Al₂O₃ and Ta₂O₅ gate pH-ISFETs", *Proc. SPIE* 2634, 210–214 (1995).
- [12] W. Torbicz and Z. Sypniewska, "An extended model of the electrolyte/hydrogen ion sensitive field effect transistor system", *Sens. Actuators B* 7, 565–571 (1992).
- [13] W. Torbicz, Z. Sypniewska, and D. Pijanowska, *Modeling of Potentiometric Semiconductor Ion Sensors*, IBIB PAN Works, No. 44, Warsaw, 1995, (in Polish).
- [14] A. Krzyśków, D. Pijanowska, and J. Kruk, "Controller of the operation point of the chemical sensor of the ion sensitive field effect transistor ISFET type", *Polish Patent* No. 178242 (1996).
- [15] W.Y. Chung, A. Krzyskow, Y.T. Lin, D.G. Pijanowska, C.H. Yang, and W. Torbicz, "Electronic circuit for ion sensor", *US Patent* No. US 6,906,524 B2 (2005).
- [16] W.Y. Chung, C.H. Yang, D.G. Pijanowska, A. Krzyskow, and W. Torbicz, "ISFET interface circuit embedded with noise rejection capability", *Electron. Letters* 40 (18), 1115–1116 (2004).
- [17] W.Y. Chung, C.H. Yang, Y.F. Wang, W. Torbicz, and D.G. Pijanowska, "A signal processing ASIC for ISFET-based chemical sensors", *Microelectronic J.* 35 (8), 667–675 (2004).
- [18] M. Dawgul, J. Jaźwiński, J. Koszur, Z. Brzózka, and W. Torbicz, "Development of an intermediate hydrogel layer for chemically modified FET based on Si₃N₄", *Proc. of Eurosensors XI Conference*, Warsaw, 1275–1278 (1997).
- [19] N.F. Starodub., W. Torbicz., D. Pijanowska, V.M. Starodub, M.I. Kanjuk, and M. Dawgul, "Optimisation methods of enzyme integration with transducers for analysis of irreversible inhibitors", *Sens. Actuators B* 58, 420–426 (1999).
- [20] M. Dawgul, D.G. Pijanowska, A. Krzyśków, J. Kruk, and W. Torbicz, "An influence of polyHEMA gate layer on properties of ChemFETs", *Sensors* 3, 146–159 (2003).
- [21] M. Dawgul, Semiconductor sensors and biosensors based on ammonium ion detection, *Thesis*, Warsaw: IBBE PAS, 2003, (in Polish).
- [22] Z. Brzózka, M. Dawgul, D. Pijanowska, and W. Torbicz, "Durable NH₄⁺-sensitive CHEMFET", *Sens. Actuators B* 44, 527–531 (1997).
- [23] D.G. Pijanowska, E. Luboch, J.F. Biernat, M. Dawgul, and W. Torbicz, "Na⁺-selective ChemFETs based on novel ionophore: bis(phenylbenzo)-13-azocrown-5", *Sens. Actuators B* 58, 384–388 (1999).
- [24] D.G. Pijanowska and W. Torbicz, "pH-ISFET based urea biosensor", *Sens. Actuators B* 44, 370–376 (1997).
- [25] D.G. Pijanowska, M. Dawgul, and W. Torbicz, "Comparison of urea determination in biological samples by EnFETs based on pH and pNH₄ detection", *Sensors* 3, 160–165 (2003).
- [26] D. Pijanowska, E. Sitarek., J. Waniewski., W. Torbicz., and A. Weryński, "Investigation of effect of the unphysiologically low pH of dialysate on peritoneal transport parameters in rats", *Proc. the 4th Europ. Conf. on Eng. and Medicine*, Warsaw, Poland, May 25–28, 182–183 (1997).
- [27] D.G. Pijanowska, N. Jaffrezic-Renault, C. Martelet, and W. Torbicz, "ISFET type urea biosensors for biomedical applications" in *Recent Research Developments in Electroanalytical Chemistry*, Chapter 3, 7–20, Trivandrum, India: Transworld Research Network, 2001.
- [28] M. Dawgul, T. Trybun, D.G. Pijanowska, and W. Torbicz, "EnFET for urea determination in biological fluids using ammonium ion detection", *Proc. SPIE* 5124, 154–161 (2003).
- [29] T. Trybun, M. Maliszewska-Mazur, M. Dawgul, D.G. Pijanowska, and W. Torbicz, "Comparison of mono- and bienzymatic urea sensitive EnFETs with ammonium ion detection", *The 18th European Conf. On Solid-State Sensors, Eurosensors XVIII*, Rome, Italy, 289–290 (2004).
- [30] D.G. Pijanowska and W. Torbicz, "The pH-detection of triglycerides", *Sens. Actuators B* 78, 263–266 (2001).
- [31] D.G. Pijanowska and W. Torbicz, "Potentiometric method for triglycerides determination", *Technology and Health Care* 9(1–2), 91–93, (2001).
- [32] W. Torbicz and D. Pijanowska, "Semiconductor type glucose sensors. State of art and perspectives", *Lecture Notes of the ICB Seminars on Drug Delivery Systems, Pharmacokinetics and Pharmacodynamics* 36, 70–75 (1997).
- [33] D.G. Pijanowska, A.J. Sprenkels, W. Olthuis, and P. Bergveld, "A flow-through amperometric sensor for micro analytical systems", *Sens. and Actuators B* 93, 98–102 (2003).
- [34] N.F. Starodub, W. Torbicz, D. Pijanowska, N. Kanjuk, M. Dawgul, and A.S. Ternovoj, "Phosphororganic pesticide control in some vegetables by enzymatic sensors based on ISFETs", *Proc. of Eurosensors X Conference*, Leuven, 925–928 (1996).
- [35] N.F. Starodub, W. Torbicz, V. Starodub, N. Kanjuk, M. Dawgul, D. Pijanowska., and K.S. Ternovoj, "Control of heavy metal ion level in some vegetables by enzymatic sensors based on the ISFETs", *Proc. of Eurosensors XI Conference*, Warsaw, 1233–1236 (1997).
- [36] W. Torbicz, M. Dawgul, V.M. Starodub, and N.I. Kanjuk, "Determination of heavy metal ions in blood serum by multi-enzymatic sensors based on the ISFETs", *Med. and Biolog. Eng. and Comp.*, Suppl. Part 1, 134 (1997).
- [37] B. Kazimierczak, A. Baraniecka, D. Pijanowska, M. Dawgul, J. Kruk, A. Krzyśków, and W. Torbicz, "Immunological reactions in potentiometric sensors", *Proc SPIE* 4887, 137–140 (2002).
- [38] D. Pijanowska and E. Remiszewska, "Potentiometric determination of phenylalanine", *The 3rd Int. Symp. on Sensor Science*, Juelich, Germany, 78–79 (2005).
- [39] D.G. Pijanowska, E. Remiszewska, J.M. Łysko, J. Jaźwiński, and W. Torbicz, "Immobilization of bioreceptors for microreactors", *Sens. and Actuators B* 91(1–3), 152–157 (2003).
- [40] W. Torbicz, D.G. Pijanowska, and E. Remiszewska, "Bio-analytical and medical trends in sensor applications, micro-bioreactor-sensor systems for monitoring of biochemical parameters", *Technology and Health Care* 9(1–2), 91–93 (2001).
- [41] D.G. Pijanowska, E. Remiszewska, C. Pederzoli, L. Lunelli, M. Vendano, R. Canteri, K. Dudziński, J. Kruk, and W. Torbicz, "Surface modification for microreactor fabrication", *The 3rd Int. Symp. on Sensor Science*, Juelich, Germany, 62–63 (2005).
- [42] Recommendations for immobilization of enzymes on EUPERGIT®, EUP_IMMO/E, 2004/08, www.roehm.com.
- [43] D.G. Pijanowska, A.J. Sprenkels, H. van der Linden, W. Olthuis, P. Bergveld, and A. van den Berg, "A flow-through potentiometric sensor for an integrated microdialysis system", *Sens. Actuators B* 103, 350–355 (2004).