

Investigation of VBLAST Equalization Technique for Underwater Acoustic Communications

B. Pranitha, L. Anjaneyulu, Hoa Le Minh, Nauman Aslam, and V. Sandeep Kumar

Abstract—Underwater Acoustic Communications (UWAC) is an emerging technology in the field of underwater communications, and it is challenging because of the signal attenuation of the sound waves. Multiple Input and Multiple-Output (MIMO) is introduced in UWAC because of its support in enhancing the data throughput even under the conditions of interference, signal fading, and multipath. The paper presents the concept and analysis of 2×2 MIMO UWAC systems that uses a 4-QAM spatial modulation scheme thus minimizing the decoding complexity and overcoming the Inter Channel Interference (ICHI). Bit Error Rate (BER) investigation is carried out over different link distances under acoustic Line of Sight (LOS). The utilization of Zero Forcing (ZF) and Vertical-Bell Laboratories Layered Space-Time (VBLAST) equalizers, which estimates the transmitted data proves a success of removing Inter Symbol Interference (ISI). The ISI caused due to multipath effect and scattering in UWAC can be reduced by iterative process considered in VBLAST. A study is made on how the distance between the transmitter and the receiver and the Doppler Effect has its impact on the performance of the system.

Keywords—Underwater Acoustic communication (UWAC), Multiple Input and Multiple Output (MIMO), Zero Forcing (ZF), Vertical-Bell Laboratories Layered Space-Time (VBLAST)

I. INTRODUCTION

UNDERWATER acoustic communications (UWAC) is considered to be one of the most complicated media for today's communications because of its irregularities in the channel. The main irregularities include the variation in random spatial-temporal-frequency, high attenuation, and a large number of multipath effects, firm bandwidth limitation, and extreme noise levels. Hence, some techniques that are used in radio communications such as Shannon theorem, existing advanced signal processing systems cannot fully be employed in UWAC [1]. Radio waves can propagate to any distance through underwater but at extra low frequencies (30Hz to 300Hz) and they need large dimension antenna and high power at the transmitter. Use of optical waves in UWAC has scattering effects. However, transmission of optical signals

necessitates high exactness towards the slender laser beams. Therefore acoustic waves are the finest solution for communicating under water in applications where tethering is undesirable [2]. At lower frequencies, bandwidth is highly restricted in acoustic propagation. The three major factors that affect the acoustic waves are attenuation, multipath propagation, and low speed of sound. The attenuation is a dependent function of the signal frequency [3]. Main applications of UWAC include military, navy and diving purposes; robotics, remotely operated vehicles (ROVs) and autonomous underwater vehicles (AUVs) [4][5]. Conveying information between them is the challenging task in UWAC [6]. Demand for high data throughput in UWAC is increasing every day. Hence, some advanced and refined technologies are introduced from wireless communications into the field of underwater communications. Among them, the highly preferred one is Multiple Input Multiple Output (MIMO). The advantages of MIMO communications, which exploits the number of physical channels between a large number of transmitting and receiving antennas, are now receiving noteworthy concentration. UWAC using MIMO systems was shown to be effective in exploiting the time and spatial diversity characteristics UWAC channel [7]. One approach for overcoming the limited bandwidth in the acoustic channel is by the use of MIMO technology in which independent streams of information are transmitted from multiple transmit elements, simultaneously, all in the same bandwidth [8]. Apart from increasing the data throughput, MIMO also reduces the effects of fading due to the increased diversity [9]. This technique can be implemented in many different ways to obtain a capacity gain or diversity gain [10]. MIMO technology transfers from various transmitting and receiving apparatus where no supplementary receiver transmitting power and spectrum resources are used. Based on these evidences it can be understood that MIMO technology increases the capacity of the channel reducing the Bit Error Rate (BER) of system in UWAC [11]. To recover the transmitted data, ZF equalization technique has been applied to MIMO in [12].

In this paper we consider MIMO with all the losses that are generally included in realistic UWAC channel models and then ZF equalization technique is applied to it. This result is then compared with a technique called Vertical-Bell Laboratories Layered Space-Time (VBLAST) in which the received signal is regenerated from the most powerful signal. Later the regenerated signal is subtracted from the received signal and this process continues [13]. It then moves forward to the detection of the second most powerful signal as it already cleared the first and so forth. In the VBLAST system, Zero-

This research is supported by the European Commission, Erasmus Mundus Action 2 Grant for the Sustainable Green Economies through Learning, Innovation, Networking and Knowledge Exchange (gLink) project (Grant Number 2014-0861) at Northumbria University, United Kingdom

First Author and Second Author are with National Institute of Technology, Warangal, India (e-mail: pranitha.boddu@gmail.com, anjan@nitw.ac.in).

Third, Fourth and Fifth Authors are with Northumbria University, United Kingdom (e-mail: hoa-le.minh@northumbria.ac.uk, nauman.aslam@northumbria.ac.uk, sandeepvangala443@gmail.com)



Forcing Successive Interference Cancellation (ZF-SIC) detector at the receiver helps to reach the high spectral efficiency. Here multiple antennas transmit the parallel data streams in the same frequency band. As a result, ZF-SIC VBLAST has extended the attention of the research in the last few years [14]. VBLAST exhibits better performance when compared to normal ZF concerning the calculation of BER [15]. The Intersymbol interference (ISI) caused due to multipath in UWAC can be reduced due to the iterative process of detecting the transmitted data that is followed in VBLAST.

II. VBLAST RELATED WORK

For the past few years, much of the work has been done in VBLAST technique, but very few researchers have concentrated on the UWAC channel. In [16]-[17] various techniques of using VBLAST algorithm has been presented with the RF channel. I. Nelson et al., in [18] worked on MIMOOFDM with UWAC and applied VBLAST technique at the receiver. Iterative decoding algorithm is performed at the receiver to reduce the results of ambient noise and acoustic interference. IFFT and FFT blocks were used at the transmitter and the receiver for multi-carrier modulation. They worked on a zero mean Gaussian random channel with ambient noise, which includes the shipping, waves, turbulence and thermal noise. Channel estimation and symbol detection are two key issues addressed here. The initial one is the Cyclic approach (CA) for scheming training sequences whereas the latter one is the iterative adaptive approach (IAA) for estimating the channel was proposed. This is used for improving the channel estimation. A robust MIMO transceiver that have a very low-complexity receiver and helps in giving better error performance is used. This helps in getting high reliability even in turbulent sea design [19].

However, the papers mentioned above did not concentrate on the absorption and spherical losses involved in the UWAC multipath channel. Doppler shift and distance between the TX and the RX are also the factors that will be investigated in this paper to evaluate its effects on the error performance of UWAC. The intention of our paper is to provide performance results of a practical MIMO underwater system over the UWAC channel by taking into account both underwater acoustic propagation and multi-path bandwidth limitation. Consideration of ZF equalizer and VBLAST gives a comparison between the BER performance of the system and various values that affects it. The paper is organized as follows: Section III describes the system model in which Section III A describes the underwater acoustic channel and III B explain the detection techniques used at the receiver. Simulation results and conclusions are given in Sections IV and V respectively.

III. SYSTEM MODELING

The UWAC channel is an exceedingly band-limited channel. The main reason for this band-limited channel is the frequency characteristics of the acoustic projector [20]. 4-Quadrature Amplitude Modulation (4-QAM) modulation format is selected as a band-efficient modulation method. It permits the transmission of 2 bits per symbol and includes four signal

points which are set in a rotational symmetry arrangement, as shown in Fig. 1. The signal of 4-QAM $s(t)$ is represented as

$$s(t) = I(t) \cos(2\pi f_0 t) - Q(t) \sin(2\pi f_0 t) \quad (1)$$

Here f_0 is the carrier's angular frequency, $I(t)$ and $Q(t)$ are the inphase and quadrature phase components [21].

The major benefit of QAM modulation variants is the efficient usage of bandwidth. This is because QAM represents more number of bits per carrier.

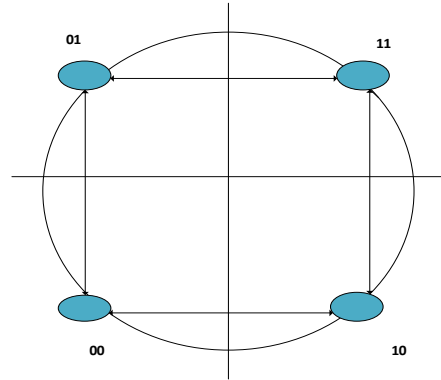

Fig. 1. 4-QAM symbol constellation.

In a 2x2 MIMO system, the generalized equation for signals at the transmitter and receiver is given as

$$\begin{bmatrix} y_1 \\ y_2 \end{bmatrix} = \begin{bmatrix} h_{11} & h_{12} \\ h_{21} & h_{22} \end{bmatrix} \begin{bmatrix} x_1 \\ x_2 \end{bmatrix} + \begin{bmatrix} n_1 \\ n_2 \end{bmatrix} \quad (2)$$

where x_1 and x_2 are the transmitted data for the MIMO system and y_1 and y_2 are the received signals. The ambient noises n_1 and n_2 are mentioned in [22]. The channel coefficients h_{11} , h_{12} , h_{21} and h_{22} are calculated using the channel characteristics that are explained in section A.

A. Channel Modeling

The underwater channel is a multipath channel that varies along with time. This causes ISI, Inter Carrier Interference (ICI), Inter Channel Interference (ICHI) and fading. Because of the harmful effect of time and frequency spreading, it is challenging to achieve high data rates in underwater communication [23]. Two effects govern multipath formation in the ocean: sound reflection which is caused at the surface, the bottom of the water body and any objects in the ocean. The second one is the refraction of the sound in the water which is a result of variation of the sound speed with depth. This is mostly marked in deep-water channels.

Fig 2 shows the multipath formation in UWAC. Rendering to the geometrical model shown in Fig 2, the time variant channel impulse response (TVCIR) can be split into three parts. The first part is the line of sight (LOS) component, the second and third parts are the reflected components from the surface and bottom of the ocean respectively.

However, in this paper we consider the LOS propagation in 2x2 MIMO wherein the transmitter and receiver are not necessarily in a straight line. This could be in an application where the transmission system is in the middle of the sea. The distance concerning the transmitter and the receiver can be varied and the channel coefficients h_{11} , h_{12} , h_{21} , and h_{22} are calculated correspondingly.

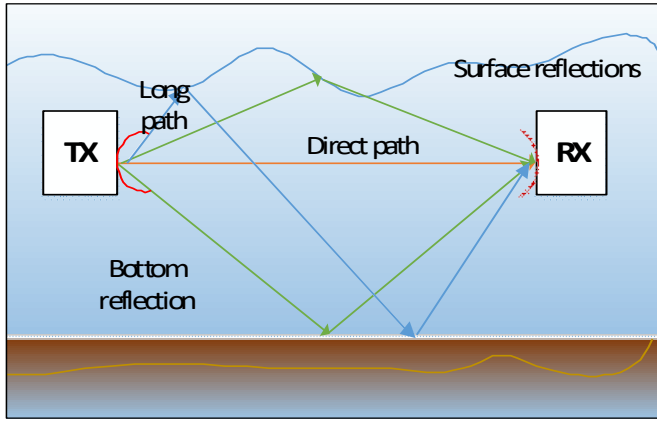

Fig 2. Scattering model of UWAC

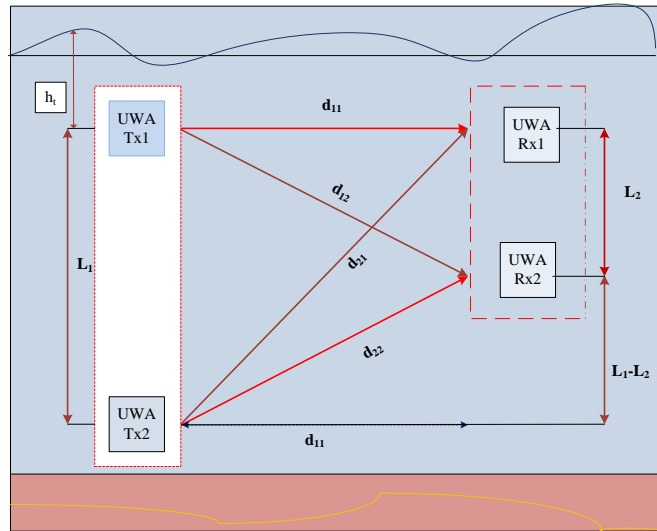

Fig 3. MIMO UWA channel

From Fig 3, the channel coefficients are calculated using the formula

$$h = \sqrt{\frac{c_R}{1+c_R}} A_s(d) A_a(d) e^{j(2\pi f_0 t + \theta_0)} \quad (3)$$

c_R is the rician factor, $A_s(d)$ is the propagation loss coefficient due to spherical spreading and $A_a(d)$ is the absorption loss. f_0 gives the Doppler frequency and θ_0 represents the phase shift of the LOS component [24]. While evaluating the channel coefficients, all the factors involved in effecting the performance of the system is considered. Doppler Effect is an extra problem in UWAC, which is normally caused by TX / RX motion and the moving sea surface [25].

The Doppler frequency f_0 is expressed as

$$f_0 = f_{max} \cos(\alpha_0 - \alpha_v^R) \quad (4)$$

where f_{max} denotes the maximum Doppler frequency. It is given by

$$f_{max} = v_R f_c / c_s \quad (5)$$

Here v_R is the receiver's speed, f_c gives the carrier frequency, and c_s signifies the speed of the sound whose value is usually 1500 m/s. The dynamics α_0 and α_v^R are taken into consideration when there is angle of arrival and angle of departure between the transmitter and the receiver.

The phase shift of the propagating signal is calculated as

$$\theta_{ij} = \frac{d_{ij}}{2\pi} * \lambda \quad (6)$$

Here i is the i^{th} transmitter, and j is the j^{th} receiver.

The wavelength λ is given by

$$\lambda = 1500 / f_c \quad (7)$$

The loss due to spherical spreading is calculated by using

$$A_s(d) = \frac{1}{d_{ij}} \quad (8)$$

Where d is the distance between the transmitter and the receiver.

The absorption loss is calculated as

$$A_a(d) = 10^{\frac{-d\beta}{20000}} \quad (9)$$

Eq (9) is an empirical formula formulated by Schulkin and Marsh for the absorption loss

The parameter β is given by

$$\beta = 8.68 * 10^3 \left(\frac{S_a f_T f_c^2 A}{f_T^2 + f_c^2} + \frac{B f_c^2}{f_T} \right) (1 - 6.54 * 10^{-4} P) \quad (10)$$

Where A and B are constants, S_a stands for salinity, f_c for carrier frequency and f_T is the relaxation frequency which is given by

$$f_T = 21.9 * 10^6 - \left(\frac{1520}{T+273} \right) \quad (11)$$

Here T is the hydrostatic temperature given in ($^{\circ}\text{C}$); P represents the hydrostatic pressure, which depends on water depth h_t , which is given by

$$P = 1.01(1 + 0.1h_t) \quad (12)$$

In Figure 3, two transmitters are placed at a distance L_1 , d_{ij} is the distance between the transmitters i and the receiver j , the two receivers are placed apart at L_2 . In the alignment, the transmitters and receivers are in parallel planes and $L_1 > L_2$. For computing the channel coefficients $\begin{bmatrix} h_{11} & h_{12} \\ h_{21} & h_{22} \end{bmatrix}$ using equation (2), we consider the distance d_{11} , d_{12} , d_{21} , and d_{22} respectively. Assume that the distances d_{11} and L_1 and L_2 are static, the remaining distances can be calculated. The phase shift of the signal θ_{ij} induced by the distance between the transmitter and the receiver is also determined for various distances.

B. Detection Techniques at the Receiver

ZF equalization and VBLAST techniques are used to process the received data to reduce the number of errors and to improve the performance of the underwater acoustic communications. A ZF decoder is the one, which generates an estimate of the transmitted data as

$$\hat{x} = \text{pinv}(H)(Y) \quad (13)$$

Here pinv gives the pseudo-inverse of the channel matrix. When we further examine how the data is estimated, we observe that

$$\hat{x} = H^{-1}Y \quad (14)$$

$$\hat{x} = H^{-1}(Hx + n) \quad (15)$$

$$\hat{x} = x + H^{-1}n \quad (16)$$

ZF comes at the expenditure of enhancing the power of noise that leads to power degradation [26]. The problem of enhancing the power of the noise can be overcome by VBLAST to some extent. In this technique, channel coding is given to individual transmitters, relating to the data stream transferred from each transmit antenna. The VBLAST architecture was primarily proposed in [27] wherein at a particular transmitter; each code block is de-multiplexed into different layers. There are two main advantages in VBLAST when compared to the existing technologies.

- i. The total channel bandwidth used in the VBLAST system is a small part in additional of the symbol rate.
- ii. The entire bandwidth is occupied simultaneously by all the transmitters at a particular time.

The detection is done at the receiver successively where the interference is cancelled. The unknown interferences are nulled by weighting the residual signal vector linearly with a ZF null vector.

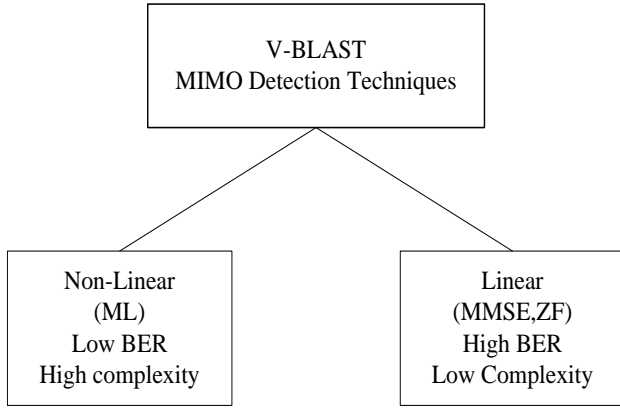

Fig 4. Classification of MIMO detection technique

From Fig 4 we notice that there are two different types in MIMO detection technique; however, in this case of UWAC, we use the high linear BER and low complexity technique to detect the received data. Though ML detection is an optimal technique for VBLAST detection, it is highly complex to implement. ZF filter with ordered successive interference cancellation (OSIC) performs the detection algorithm in VBLAST.

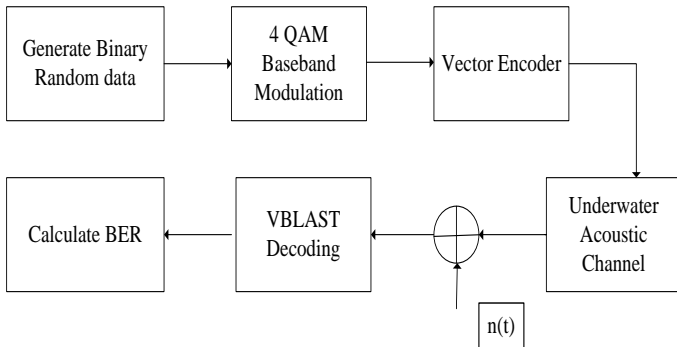

Fig 5. VBLAST in UWAC

Fig 5 gives the block diagram of the VBLAST algorithm. At the transmitter binary random generator produces the transmitted bits which are modulated using a 4-QAM baseband modulator. The vector encoder plots the symbols to the individual transmitter. Here we are considering the UWAC channel with all the losses involved in it, which is modelled in section 3.1. Two interferences are occurring in this case. They are spatial multi-stream interference and temporal ISI. Since the underwater channel that we are considering is a frequency flat fading LOS MIMO channel, the latter one does not exist. And so equalization for spatial multi-stream interference is done. To overcome this interference VBLAST MIMO concept

with SIC at the receiver is proposed. It follows the iteration procedure. After deciding the first signal stream with the detection process, it will be subtracted from the original receiving vector by giving the feedback. This process reduces the ISI on the resulting MIMO layers [28]. The order selection rule of the algorithm prioritizes the sub channel with the smallest noise variance. The algorithm will perform nulling and figures out the decision slice the totalled decision statistic and generates the decision. Then cancellation is performed by decision feedback, and the new pseudo inverse is computed for the next iteration.

The algorithm of VBLAST/ZF is as follows

Step 1: Initialization

$$i=1, y_i=y, H_i=H$$

$$G_i=H^{\dagger}$$

Step 2: SIC

For $i=1:N_t$

$$\text{Ordering: } K_i = \underset{j \notin \{K_1, K_2, \dots, K_{i-1}\}}{\text{argmin}} \|(w_i)_j\|^2$$

$$\text{Nulling Vector: } w_{K_i} = (G_i)^{K_i}$$

$$\text{Nulling: } y_{K_i} = (W_i)_{K_i} y_i$$

$$\text{Hard decision: } \hat{x}_{K_i} = Q(y_{K_i})$$

$$\text{SIC: } y_{i+1} = y_i - (H_{K_i}) \hat{x}_{K_i}$$

$$\text{Update the channel matrix: } H_{i+1} = H_{\bar{K}_i}$$

$$\text{Calculate the weight matrix: } G_{i+1} = H_{i+1}^{\dagger}$$

End

Y is the received vector, H is the channel matrix. H^{\dagger} denotes the pseudo-inverse of the matrix H . N_t denotes the number of transmitters. $(w_i)_j$ is the j th row of (w_i) , $Q(\cdot)$ is the quantizer to the nearby constellation point. (H_{K_i}) represents the K_i^{th} column of H . $(H)_{\bar{K}_i}$ signifies the matrix obtained by making the columns k_1, k_2, \dots, k_i as zeros of H , and $\text{pinv}(H)_{\bar{K}_i}$ denotes the $(H)_{\bar{K}_i}$.

The two main operations that are performed at the detection process are

i. Interference suppression: The received vector is projected onto the perpendicular subspace crossed by the interfering signals. This process reduces the interference followed by normal detection of the first symbol.

ii. Interference cancellation: Subtraction of the received signal and the detected signal is done in this step [29].

VBLAST has an interesting feature wherein no plain orthogonalization of the transmitted signals is forced by the transmitting structure. However, the propagation situation itself exhibits noteworthy multipath. This is done to achieve the signal de-correlation necessary to separate the co-channel signals.

IV. SIMULATION RESULTS

In this paper, we investigated a 2×2 MIMO UWAC channel with the motive to prove that VBLAST along with ZF equalizer proves to perform better than the original ZF equalizer. However, here we considered the realistic underwater channel along with the absorption and spherical loss. The numerical values of the equations that are considered in Section III B are tabulated in Table I.

Here, two techniques are considered for detecting the received data. The former one is the ZF equalizer which inverses the channel matrix to get the estimated data. The second one is the VBLAST technique where it performs a spatial nulling process and employs a Zero-Forcing non-linear detection algorithm. This process is combined with symbol cancellation to further improve the system performance.

TABLE I
SIMULATION PARAMETERS

Symbol	Parameters	Values
N_t	Number of transmitters	2
N_r	Number of receivers	2
N	Number of transmitted bits	10000
m	Order of QAM	4
c_R	Rice factor	0.56
d_{11}	distance	1m – 100 m
f_c	Carrier frequency	10kHz
T	Temperature	10°C
S_a	Salinity	35 PSU
P	Pressure	11 kg/cm ²
c_s	Speed of the sound	1500 m/s
L_1	Distance between transmitters	5 m
L_2	Distance between receivers	2 m
v_R	Speed of the receiver	9 m/s
h_t	Shallow water depth	90m

These two techniques are compared in the UWAC channel. In the system, data arrives at the receiver during different time periods, and thus it interferes highly cancelling each other out.

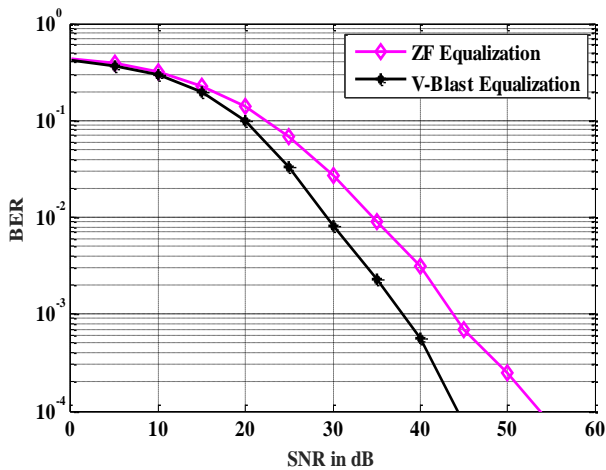

Fig 6. SNR to BER curve for ZF and VBLAST equalization techniques in UWAC

VBLAST method helps to overcome multipath. This can be done by using the scattering characteristics of the propagation environment which helps to boost up the transmission accuracy by treating the diversity of scattering paths as distinct parallel sub-channels [30]. In fig 6, the upper curve shows the

performance of the ZF equalization technique while the lower curve shows the VBLAST technique that is observed to be of better performance. To reduce the complexity in simulation the distance between the transmitter and the receiver is considered as 5m for simulating the results that are shown in Fig 6. As mentioned in the algorithm, in VBLAST nullifying the weighted terms with cancellation is performed which is better than pure nulling. Hence, the BER performance of the UWAC system is improved by almost 8dB with VBLAST technique when compared to that of a ZF equalization technique.

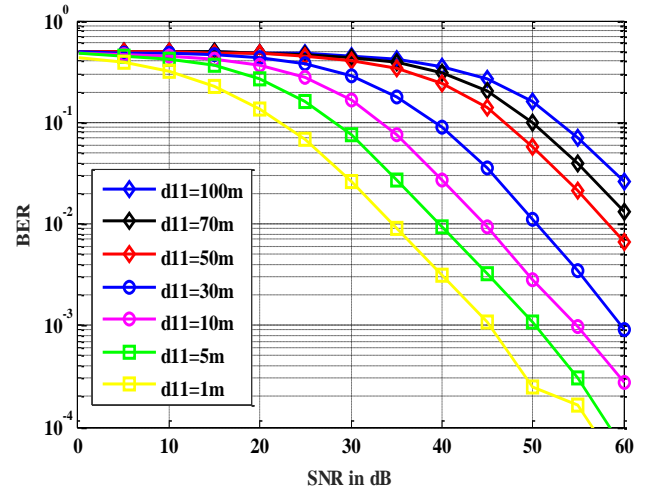

Fig 7. SNR to BER for ZF Equalization with different distances

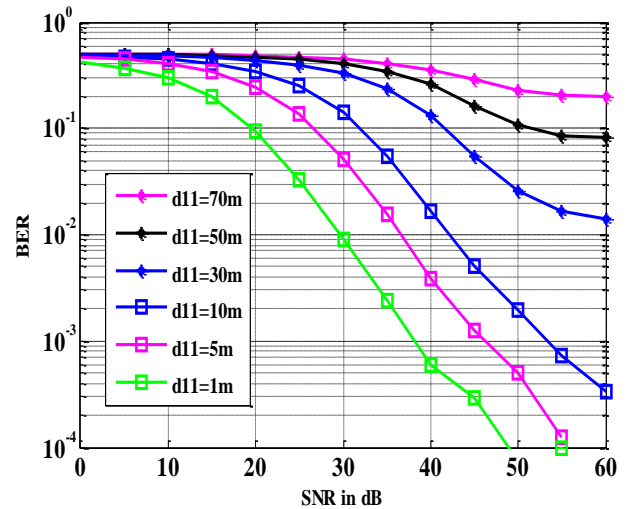

Fig 8. SNR to BER for VBLAST with different distances

We further investigate the ZF and VBLAST performances with varying distances between TX1 and RX1. Figure 3 gives the geometrical representation of the channel model where in the link distance (d_{11}) is increased from 1m to 100m. This increase in distance will introduce a larger absorption and cause spherical losses which are calculated by using (8) and (9). We understand that as the distance d_{11} varies, all other connecting distances that are used to calculate different channel coefficients (h_{11} , h_{12} , h_{21} and h_{22}) also vary. Now the changing distances have different phase shifts. They are calculated respectively using (6). However, VBLAST approach significantly improves spectral efficiencies, and

robustness as well as acceptable BER as shown in Fig 6, even when we consider the regular ZF equalization technique, we observe that as the distance between the Tx1 and the Rx1 increases the performance of the underwater communication system decreases. It is shown in Fig 7. To improve the performance, VBLAST algorithm has been introduced. This is done at lower complex level availing the spatial dimension of highly scattering environment [31]. When we consider the VBLAST algorithm, as the distance varies in the same way of ZF equalizer, it is observed that the performance also varies. From the above two graphs (Fig 7 and 8) we observe that as the distance is increasing between the Tx1 and Rx1, the bit error rate is also increasing which worsens the performance of the UWAC system. The interferences with extra symbols are cancelled when the initial symbol that is decoded is fed back again and this continues until all the symbols are decoded. However the symbol with largest SNR is decoded first. So in this highly scattering underwater environment a very good spectral efficiency is achieved due to its decision feedback structure [32].

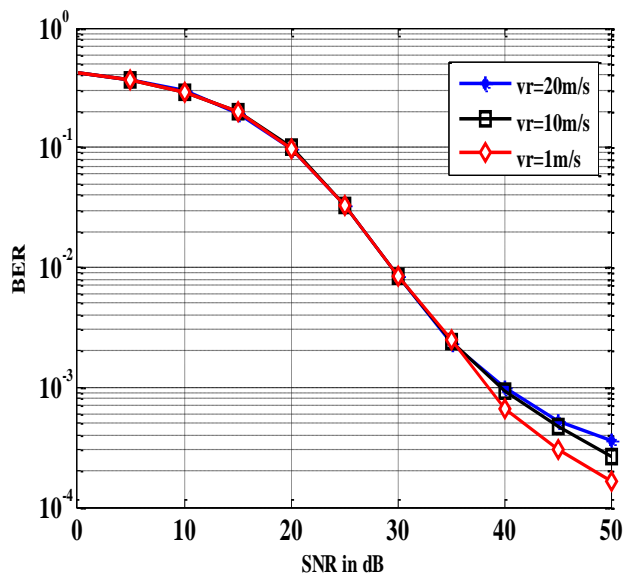

Fig 9. SNR to BER curve for VBLAST with different relative motions

Doppler shift is also one of the main characteristic of UWAC. The velocity between the source and the receiver, and the speed of propagation of the signal are the main reasons for the Doppler shift in frequency. Though ZF equalizer, that enhances the noise component, does not show much difference concerning the Doppler Effect in our system, the VBLAST system with MIMO explains clearly the effect of Doppler frequency. It is because in the marine environment; acoustic transmission is not easy under the water. The UWA environment is highly resonating which results in many copies of the transmitted signal being received. This is because of the relative motion between the transmitter and the receiver as explained in equation (5). This relative delay at the receiver changes with the time. Doppler Effect in UWAC is normally caused by the expansion and shortening of the surface reflected transmission paths and also by the movement of transmitter and receiver (or both). This Doppler Effect poses a great challenge to the decoding of the data at the receiver. This problem actually increases when there is a need for achieving a

high data transmission rate [33]. At the receiver, the Doppler Effect shifts the frequency because of the motion between the transmitter and the receiver. From Fig 9, we observe that at high SNR, there is a variation in the performance of the UWA system. As the relative motion between the transmitter and the receiver increases the number of errors increases eventually degrading the performance of the system. However, there is no much variation before 35dB. SNR is the parameter to measure the quality of the communication system which is also the same case for UWAC system. Along with the wind and wave action that plays a major role in underwater communications, the reduced SNR value does not contain any increased losses connected with the increase scattering that the wave action generates [34]. At low SNR, the error is subjected by the estimation of the transmitted symbol. While at comparatively higher SNR, the error is subjected by the estimation of the corresponding antenna number [35]. Doppler coefficient estimation variance gradually decreases as the improvement of SNR or Doppler factor decreases close to zero. The estimate variance of the Doppler coefficient with a higher SNR is a small amount [36].

CONCLUSION

This paper proves that VBLAST algorithm outperforms the ZF equalizer when the realistic underwater channels with the losses involved in it are considered. Effects of distances and Doppler shift are also explained concerning the performance of the UWAC system. Eventual goals of the future generation UWAC systems are high data rate, performance and best utilization of the bandwidth. We may get better performance with the increased number of receivers in the VBLAST system instead of an equal number of transmitters and receivers. Many other equalization techniques, which further improve the performance of the underwater system, have to be implemented in this realistic channel, which considers the absorption and spherical coefficients. Multiple scattering of the underwater channels has to be studied further. As we increase the number of receiving antennas, further improvement is observed, and BER is decreased.

ACKNOWLEDGEMENTS

The authors are grateful for gLINK funding and Northumbria University for their support.

REFERENCES

- [1] Xu, Tianzeng, and Lufeng Xu. Digital Underwater Acoustic Communications. Elsevier, Academic Press 2016.
- [2] Stojanovic, M., 1999. Underwater acoustic communication. Wiley Encyclopaedia of Electrical and Electronics Engineering, pp.1-12
- [3] Stojanovic, M., 2007. On the relationship between capacity and distance in an underwater acoustic communication channel. ACM SIGMOBILE Mobile Computing and Communications Review, 11(4), pp.34-43.
- [4] Diamant, R., Bucris, Y. and Feuer, A., 2016. An efficient method to measure the reliability of underwater acoustic communication links. Journal of Ocean Engineering and Science, 1(2), pp.129-134.
- [5] Gu, S., Guo, S. and Zheng, L., 2018, August. Characteristic Evaluation of the Mobile Acoustic Communication for Spherical Underwater Robots (SUR III). In 2018 IEEE International Conference on Mechatronics and Automation (ICMA) (pp. 2191-2196). IEEE.
- [6] Pranitha, B. and Anjaneyulu, L., 2016, December. Performance evaluation of Underwater Communication system using block codes. In Eco-friendly Computing and Communication Systems (ICECCS), 2016 Fifth International Conference on (pp. 58-62). IEEE.

- [7] Diamant, R., Feuer, A., and Dotan, A.A., 2007. Time reversal MIMO architecture for very shallow underwater acoustic communication (pp. 1-5). IEEE.
- [8] BOUVET, P.J. and LOUSSERT, A., MIMO underwater acoustic communications over shallow water channel.
- [9] Garg, J., Gupta, K. and Ghosh, P.K., 2013. Performance Analysis of MIMO Wireless Communications over Fading Channels-A Review. *International Journal of Advanced Research in Electrical, Electronics and Instrumentation Engineering*, 2(4), pp.1272-1302.
- [10] Goswami, Y. and Naik, K.K., 2018. Comparative survey on Underwater and Terrestrial Communication Data rates.
- [11] Zhang, L., Li, M., Li, G. and Wang, R., 2015. Symbol estimation algorithm for MIMO underwater acoustic communication system based on a multiplicative noise model. *Mathematical Problems in Engineering*, 2015.
- [12] Pranitha, B, Le Minh, H., Aslam, N., Anjaneyulu, L. and Vangala, S., 2018, July. BER Performance Investigation of MIMO Underwater Acoustic Communications. In 2018 11th International Symposium on Communication Systems, Networks & Digital Signal Processing (CSNDSP) (pp. 1-5). IEEE.
- [13] Rana, R.C. and Rathod, J.M., 2017. Performance Analysis of Efficient Power Allocation Techniques with Different Modulation for 4X4 VBLAST MIMO-OFDM System. *Indian Journal of Science and Technology*, 10(17).
- [14] Shen, C., Zhu, Y., Zhou, S. and Jiang, J., 2004, November. On the performance of VBLAST with zero-forcing successive interference cancellation receiver. In *Global Telecommunications Conference, 2004. GLOBECOM'04*. IEEE (Vol. 5, pp. 2818-2822). IEEE
- [15] Patel, K.V. and Patel, M., VBLAST Architecture: A New Transmission Scheme for MIMO-OFDM. PG Student, EC Department, KIT RC, Kalol, Gujarat, India (ISSN: 0975-6779| NOV 12 TO OCT 13| VOLUME-02, ISSUE-02).
- [16] Zhang, S., Nie, C., Lu, L., Zhang, S. and Qian, G., 2012, October. MIMO physical layer network coding based on VBLAST detection. In 2012 International Conference on Wireless Communications and Signal Processing (WCSP) (pp. 1-5). IEEE.
- [17] Akbar, N., Khan, A.A., Butt, F.Q., Saleem, M.S., Riffat, S. and Iqbal, R., 2013, April. Performance analysis of energy detection spectrum sensing using MIMO-OFDM VBLAST Test Bed. In *Wireless and Mobile Networking Conference (WMNC), 2013 6th Joint IFIP* (pp. 1-4). IEEE.
- [18] Li, Y., Zhang, S. and Wang, H., 2013. BER performance analysis of MIMO Physical-layer Network Coding based on VBLAST detection Target, 1, p.2.
- [19] Nguyen, T.N., Lai, X., Tran, B., Nguyen, Q.K. and Nguyen, T.D., 2014, April. Performance analysis of the VBLAST algorithm for MIMO-OFDMA systems on spatial correlated channels. In *Computing, Management and Telecommunications (ComManTel), 2014 International Conference on* (pp. 146-151). IEEE.
- [20] Diamant, R. and Lampe, L., 2018. Low Probability of Detection for Underwater Acoustic Communication: A Review. *IEEE Access*, 6, pp.19099-19112.
- [21] Ochi, H., Watanabe, Y. and Shimura, T., 2004. Experiments on acoustic communication with quadrature amplitude modulation in multipath environment. *Japanese journal of applied physics*, 43(5S), p.3140.
- [22] Stojanovic, M. and Preisig, J., 2009. Underwater acoustic communication channels: Propagation models and statistical characterization. *IEEE communications magazine*, 47(1), pp.84-89
- [23] Pranitha, B. and Anjaneyulu, L., 2016, April. Review of research trends in underwater communications—A technical survey. In *Communication and Signal Processing (ICCSP), 2016 International Conference on* (pp. 1443-1447). IEEE.
- [24] Naderi, M., Pätzold, M. and Zajic, A.G., 2014, July. A geometry-based channel model for shallow underwater acoustic channels under the rough surface and bottom scattering conditions. In *Communications and Electronics (ICCE), 2014 IEEE fifth international conference on* (pp. 112-117). IEEE.
- [25] Pranitha, B. and Anjaneyulu, L., 2016. BER Performance Evaluation of Underwater Communication System with Spatial Diversity. *Indian Journal of Science and Technology*, 9(S1).
- [26] Malik, M. and Kaushik, R., 2016. MIMO-OFDM and idma scheme in underwatercommunication. *IJITR*, 4(3), pp.2971-2976.
- [27] Wolniansky, P.W., Foschini, G.J., Golden, G.D., and Valenzuela, R.A., 1998, September. VBLAST: An architecture for realizing very high data rates over the rich-scattering wireless channel. In *Signals, Systems, and Electronics, 1998. ISSSE 98. 1998 URSI International Symposium on* (pp. 295-300). IEEE.
- [28] Schwarz, R.T., Knopp, A. and Lankl, B., 2012, March. SC-FDE VBLAST system concept for MIMO over satellite with antenna misalignment. In *Systems, Signals, and Devices (SSD), 2012 9th International Multi-Conference on* (pp. 1-8). IEEE.
- [29] Patel, K.V. and Patel, M., VBLAST Architecture: A New Transmission Scheme for MIMO-OFDM. PG Student, EC Department, KIT RC, Kalol, Gujarat, India (ISSN: 0975-6779| NOV 12 TO OCT 13| VOLUME-02, ISSUE-02).
- [30] Gohar, N.D. and Rafique, Z., 2003. VBLAST: a space-division multiplexing technique is providing a spectral efficiency necessary for high data rate wireless networks. Ghulam Ishaq Khan Institute of Engineering Sciences, Pakistan.
- [31] Barmashe, P.K., and Nema, R., Performance Evaluation of VBLAST MIMO System using BPSK.
- [32] Chourasia, S.K. and Pandey, R., 2014. Extensive Survey on MIMO Technology using V-BLAST Detection Technique. *International Journal of Computer Applications*, 98(5).
- [33] Caley, M. and Duncan, A., 2013. Investigation of underwater acoustic multi-path Doppler and delay spreading in a shallow marine environment. *Acoustics Australia*, 41(1), pp.20-28.
- [34] Burrowes, G. and Khan, J.Y., 2011. Short-range underwater acoustic communication networks. In *Autonomous Underwater Vehicles. InTech*.
- [35] Mesleh, R., Ganesan, S. and Haas, H., 2007, September. Impact of channel imperfections on spatial modulation OFDM. In *Personal, Indoor and Mobile Radio Communications, 2007. PIMRC 2007. IEEE 18th International Symposium on* (pp. 1-5). IEEE.
- [36] Xiao, Z., Xiao, H., Jingwei, Y. and Xueli, S., 2013. Study on Doppler effects estimate in underwater acoustic communication. *The Journal of the Acoustical Society of America*, 133(5), pp.3463-3463.