

Low-voltage overhead lines topology identification method based on high-frequency signal injection

HAOTIAN GE, BINGYIN XU, XINHUI ZHANG, YONGJIAN BI

*Shandong University of Technology
China*

e-mail: sdutght@163.com, xuby@vip.163.com, zhxh@sdut.edu.cn, biyj1996@foxmail.com

(Received: 04.02.2021, revised: 28.04.2021)

Abstract: The topology of low-voltage distribution systems changes with the load or the on/off position of the circuit switch. This will affect power flows, losses, and so on. This paper submits a new method to identify the topology of a low-voltage feeder using the injection high-frequency signal. An inductor can block the high-frequency signal. It can change the propagation direction of the injected high-frequency signal to make it propagate unidirectionally along the low-voltage feeder. By injecting a 5 MHz sinusoidal signal from the upstream direction of the low-voltage feeder, all the line segments and devices on the feeder can be identified. The wavelength of the high-frequency signal is short. The wavelength of the 5 MHz signal is 60 meters. Through the delay of different observation points on the feeder, the length of the line section can be roughly calculated. The high-frequency signal has an obvious reflection on the feeder. Using this feature, we can roughly calculate the length of the line segment. The correctness of the method is demonstrated by MATLAB simulation verification.

Key words: high-frequency signal injection, low-voltage overhead line, topology identification

1. Introduction

The low-voltage distribution system delivers power to the ultimate user's meter. A low-voltage feeder typically starts with a distribution substation [1]. Each distribution substation will serve one or more feeders. With a rare exception, feeders are radial, which means that there is only one path for power to flow from the distribution substation to the end users [2]. Due to the change of load, the topology of low-voltage distribution networks often changes. Sometimes the increase of new users will also cause the change of the original topology. In recent years, the



connection of uncontrollable power generation units such as photovoltaic power generation and wind power generation, electric vehicles and other new load units has changed low-voltage feeders and their topology. Therefore, the identification of a topology is very important. The topology identification method of the distribution system is to analyse equipment connectivity to support network functions and for connectivity presentation. It is an important role in the distribution system analysis, including power flows, feeder losses, fault location, and so on [3,4].

Topology identification of distribution feeders mostly takes advantage of the radioactive structure of the distribution feeders. Using the adjacent relationship stored in the intelligent electronic device (IED), the topological relationship of the whole distribution feeder can be obtained through one by one query [5,6]. The application of broadband power line communication has greatly improved the bandwidth and quality of data transmission. The method of topology identification based on the difference of voltage, current, active and reactive power data is also applied in distribution network [7–11]. Another method is to inject a voltage or current signal which is obviously different from the power frequency on the distribution feeder, so that the topology can be identified according to the injected signal [12].

Therefore, a method of injecting a high-frequency signal and using an inductor about 1 mH to control the propagation direction of a high-frequency signal to identify the topology of low-voltage distribution networks is proposed in this paper. The length of the distribution feeder is generally less than 1000 meter. A high-frequency signal of 5 to 15 MHz is used for the identification of the connection relationship between related equipment on the feeder and the calculation of the length of the line segment.

2. Constructions of low-voltage overhead lines

2.1. Low-voltage distribution network

The low-voltage distribution network is the power distribution network from the secondary side of the distribution transformer to the household interface. Similarly to Europe, China uses a 380/220 V secondary system. The phase-to-phase voltage is 380 V and the phase-to-neutral voltage is 220 V. In most cases, only one distribution transformer supplies power to the end customers, and the loads. The radius of the power supply is usually less than 1000 meters in urban areas. A low-voltage feeder can be divided into two parts, a mainline and lateral. The mainline is the backbone of the feeder, which is normally a three-phase modestly large conductor, such as a 120, 150 or 185 mm² aluminum or copper conductor. The lateral is the customer line that is from the mainline to the customer's electric meter. The lateral may be one-phase, two-phase or three-phase. The conductor of laterals may be 70 or 120 mm² aluminum or copper conductor.

The most common feeders are four-wire, multi-grounded systems: three-phase conductors plus a multi-grounded neutral. Single-phase loads are connected between one phase conductor and the neutral. The multi-grounded neutral acts as a return conductor and as an equipment safety ground. A single-phase line has one phase conductor and the neutral, and a three-phase line has three phases and the neutral. Most feeders are radial and the lengths are less than 1000 meters.

2.2. Structure of low-voltage distribution network

The low-voltage feeders are usually found along roads and streets. Along streets, alleys, many of the distribution lines that feed customers are overhead structures. For a three-phase feeder, the most common structure is a horizontal layout with a 1.5 or 2-meter crossarm on an 8 or 10-meter pole as in Fig. 1.

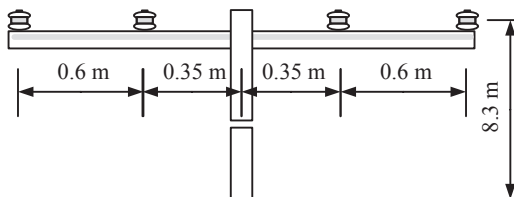

Fig. 1. Crossarm construction

Utilities often use covered conductors, conductors with an insulation covering (as in Fig. 2). The most commonly used insulation material is cross-linked polyethylene (XLPE). Most conductors of low-voltage feeders are either aluminum or copper. Aluminum is used for almost all overhead installations in China. Aluminum conductors with XLPE insulation (as in Fig. 2(a)) are also called JKLYJ in China. And it is lighter and less expensive for a given current-carrying capability than copper. Copper may be used in coastal areas or areas with serious chemical pollution. Copper conductors with XLPE insulation (as in Fig. 2(b)) are also called JKYJ in China.

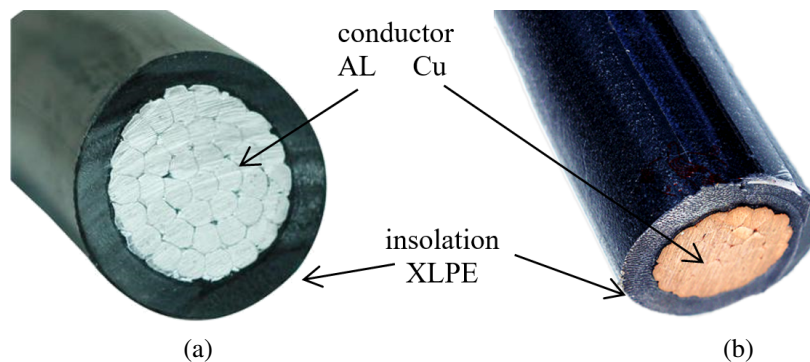

Fig. 2. Aerial insulation cable structure: aluminum conductor (a); copper conductor (b)

3. Low-voltage overhead line models

3.1. Overhead line segment model

Modeling of low-voltage overhead line segments is a critical step in the analysis of a low-voltage feeder and topology identification. The basic parameters of the line segment are series impedance (resistance and inductance) and shunt admittance (conductance and capacitance).

The conductance is used to model dielectric losses, or equivalent leakage current. It is very small compared to the capacitive susceptance. So, the conductance is usually ignored. The overhead line segment model is as shown in Fig. 3. There are a lot of single-phase loads in the low-voltage network. In order to distinguish the A, B and C phase wires, the injected signal is of a wire-to-ground type. So, it is easy to distinguish the connections between the A, B, and C phase wires.

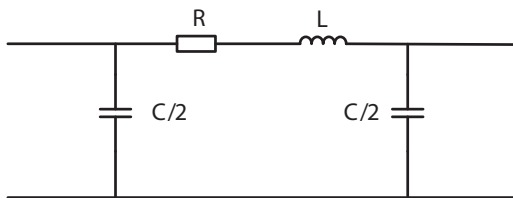

Fig. 3. Overhead line segment model

For topology identification, a high-frequency signal of 5~15 MHz is needed to be injected into the feeder. The corresponding wavelength of the injected signal is 20~60 meters. The lengths of overhead lines are generally several hundred meters. So, the overhead line segment should be regarded as a transmission line and distributed parameter model should be adopted.

3.2. RLC parameters of overhead lines

For an overhead line segment consisting of N conductors, three N -by- N matrices need to be calculated: the series resistance matrix $[R]$, the series inductance matrix $[L]$, and the shunt capacitance matrix $[C]$. The matrices can be calculated by MATLAB or ATP-EMTP.

For an overhead line, the earth is assumed an infinite uniform solid. The inductive reactance (self and mutual) component of the impedance is a function of the total magnetic fields surrounding a conductor. The capacitance of a line is the result of the potential difference between conductors. A charged conductor creates an electric field that emanates outward from the center of the conductor.

3.3. Examples

An overhead single-phase two-wire line is constructed as below. The phase and neutral conductors are 70 mm² AAC covered with XLPE. The pole with a crossarm is shown in Fig. 1. The distance between two conductors is 600 mm. The height of the pole is 8.3 meters. At frequency = 5 MHz, the matrices $[R]$, $[L]$, and $[C]$ are calculated by ATP-EMTP as below:

$$\begin{aligned}
 \mathbf{R} &= \begin{bmatrix} 769.0 & 743.7 \\ 743.7 & 769.0 \end{bmatrix} \Omega/\text{km}, \\
 \mathbf{L} &= \begin{bmatrix} 1.649 & 0.691 \\ 0.691 & 1.649 \end{bmatrix} \text{mH}/\text{km}, \\
 \mathbf{C} &= \begin{bmatrix} 8.466 & 3.491 \\ 3.491 & 8.349 \end{bmatrix} \text{nF}/\text{km}.
 \end{aligned}$$

The $[R]$, $[L]$, and $[C]$ are also listed in Table 2.

4. Topology identification based on high-frequency signal injection

4.1. High-frequency current injection

For a high-frequency signal, an inductor has an obvious blocking effect. The distribution of a high-frequency signal can be changed obviously by placing inductors on the circuit. As shown in Fig. 4, the lengths of line segments 32–71, 71–84 and 84–52 are 300, 300 and 200 meters, respectively. The feeder is a three-phase, four-wire, 120 mm² aluminum system with XLPE. Injecting a 5 MHz current signal into the feeder, and adding an inductor 1 mH on one side shows (it can be seen in Fig. 5) that the current signal on the side of the inductor (71 *L*) is obviously much smaller than that on the side without the inductor (71 *R*). Using this feature, topology recognition can be carried out.

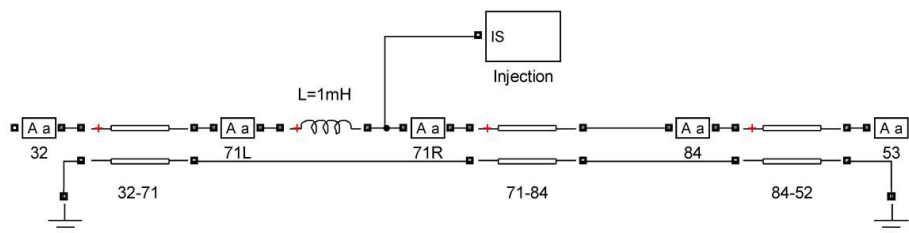

Fig. 4. Injection of a high-frequency signal into the feeder

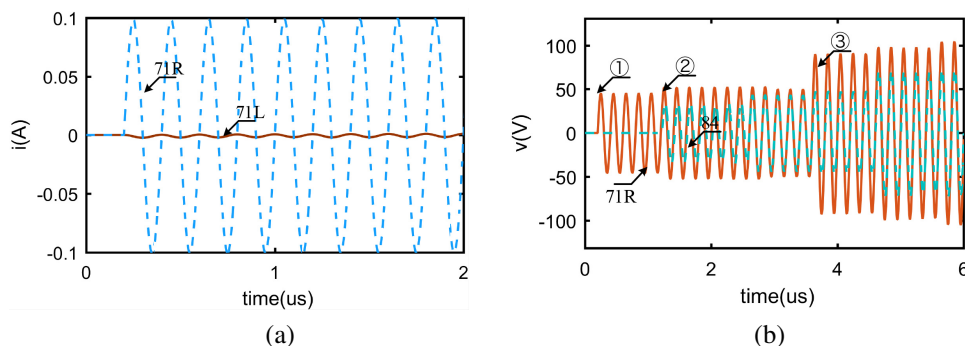

Fig. 5. Results of single injection: current i versus time (a); voltage v versus time (b)

The current distribution in Fig. 5(a) shows that the voltage at node 84 significantly lags behind that at node 71 *R*. This is caused by the spread of high-frequency signals. Comparing points ① and ② marked in the figure, the point ② lags about 5 cycles behind. The wavelength of the injected 5 MHz signal is about 60 meters. Five cycles behind, the corresponding line length is 300 meters. This is consistent with the length of the line segment 71–84 (300 m). Using this feature, the length of the line segment can be roughly calculated.

The voltage at node 71 *R* in Fig. 5(b) is significantly different from the previous voltage due to the superposition of the signal and the reflected signal transmitted to the end of the line. ③ is about 17 cycles behind ①. Since the signal travels to the end of the line and bounces back, the

length of the line should be $60 \times 17/2 = 510$ meters. This result is approximately equal to the sum (500 m) of line segments 71–84 (300 m) and 84–52 (200 m). Using this characteristic, one can roughly calculate the length of the downstream lined.

4.2. Effect of loads

Low voltage load usually includes resistance and reactance. Take the common 10 kVA three-phase load as an example, the power factor is 0.9, and the corresponding impedance is:

$$Z = 13.1 + j6.33 \Omega.$$

It is assumed that the resistance (R) and inductance (L) do not change with frequency. So, for 5 MHz, the impedance is:

$$Z = 13.1 + j633000 \Omega.$$

The reactance is far greater than the resistance, so it can be assumed that the terminal is open-circuit, and the high-frequency signal is directly reflected back.

4.3. Method of topology identification

The method of injecting a high-frequency signal to identify topology can start from a power point observing how the signal travels along the line. When injecting a signal, in order to limit the flow direction of it, a reactance should be installed at the upstream of the power supply to identify the topology by detecting the presence or absence of downstream high-frequency signals. To identify single-phase lines, high-frequency signals can be injected into the upstream according to the A, B and C phases. The specific steps are as follows:

1. The identification of the low-voltage topology starts from the low-voltage bus of the distribution transformer. Each feeder is identified in turn.
2. For each feeder, a high-frequency signal is injected and a 1 mH inductor is placed upstream to prevent the high-frequency signal from propagating upstream.
3. Whether the observation point downstream of the line belongs to the feeder can be identified by the detection of high-frequency signals. For a 3-phase line segment, if the high-frequency signal is detected, it belongs to this feeder. If the high-frequency signal is not detected, it does not belong to this feeder. For the topology identification of the single-phase load, high-frequency signals should be sequentially injected into the A, B and C phases.
4. For the detection point, the detected high-frequency signal, phase angle and delay analysis, roughly calculate the length of the line.
5. For the monitoring points of the line in turn the signal is injected until the end of the line.

5. Simulation verification

5.1. Simulation model

To verify the effectiveness of the topology identification method that uses high-frequency signal injection, a simulation model was built as shown in Fig. 6. It is built with reference to IEEE 13-node feeders. The model of an IEEE 13-node feeder includes single-phase line segments, two-

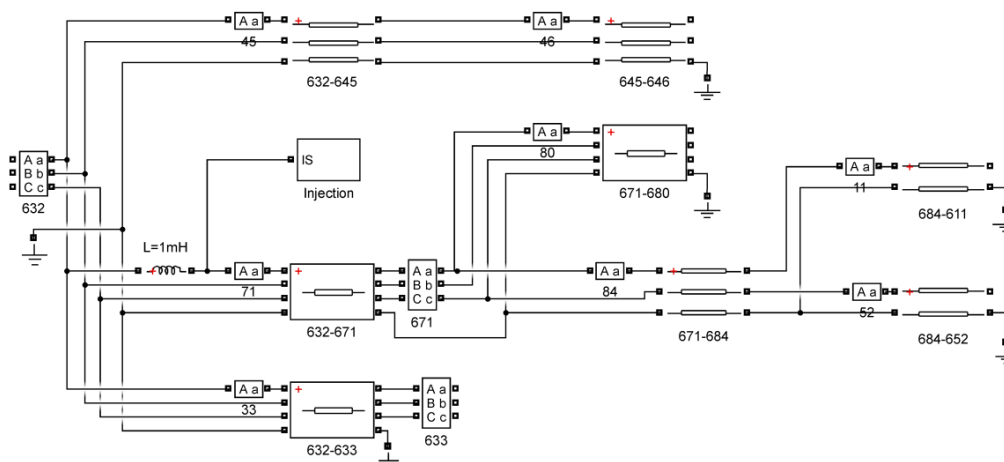

Fig. 6. Experimental mode in MATLAB

phase line segments and three-phase line segments, and the relevant line parameters are given in Table 1. In order to make the model more consistent with the characteristics of a low-voltage power grid, the model is simplified and modified as below:

1. Node 650 is omitted. The regulating transformer between nodes 650 and 632 is also omitted.
2. The model does not include the switch between nodes 671 and 692. Node 692 is also omitted, and the line segment between 671–692 is also deleted.
3. To simplify the line structure, the underground cable is changed into the overhead line.
4. The feeder includes a neutral wire. The conductor size of the neutral wire and phase wire is the same. The single-phase line has two wires. The two-phase line is a three-wire structure and the three-phase line adopts a four-wire structure.
5. The specification of the line is as in Table 1 and the parameters are as in Table 2.

Table 1. Configuration of the line segment

Line segment	Length (meters)	Phasing	Wire (mm ²)	Parameters ID
632–645	150	A B N	120*3	2
632–671	600	A B C N	185*4	1
632–633	300	A B C N	185*4	1
645–646	100	A B N	120*3	2
671–680	300	A B C N	185*4	1
671–684	100	A C N	120*3	2
684–611	100	A N	70*2	3
684–652	250	C N	70*2	3

Table 2. *RLC* parameters of lines

ID	R (Ω/km)	L (mH/km)	C (nF/km)
1 (185*4)	[759.8 743.7 741.1 737.3	[1.555 0.691 0.537 0.461	[9.690 -3.296 -1.423 -1.046
	743.7 759.8 743.5 741.1	0.691 1.555 0.660 0.537	-3.296 10.33 -2.595 -1.392
	741.1 743.5 759.8 743.7	0.537 0.660 1.555 0.691	-1.423 -2.595 10.31 -3.234
	737.3 741.1 743.7 759.8]	0.461 0.537 0.691 1.555]	-1.046 -1.392 -3.234 9.518]
2 (120*3)	[763.5 743.7 741.1	[1.600 0.691 0.537	[9.175 -3.217 -1.692
	743.7 763.5 743.5	0.691 1.600 0.660	-3.217 9.658 -2.867
	741.1 743.5 763.5]	0.537 0.660 1.600]	-1.692 -2.867 8.842]
3 (70*2)	[769.0 743.7	[1.649 0.691	[8.466 -3.491
	743.7 769.0]	0.691 1.649]	-3.491 8.349]

5.2. Topology identification

The parameters of the line can be calculated by MATLAB and ATP-EMTP. The program `power_lineparam` in MATLAB can calculate the parameters of overhead lines. ATP-EMTP is also used to calculate the parameters of overhead lines or underground cables. In China, low voltage distribution lines are overhead insulated wires. The overhead line calculated by `power_lineparam` in MATLAB is bare wire, and the case of an insulated conductor is not considered. The parameters of resistance and inductance of an insulated wire differ little compared with the parameters of bare wire. But the capacitance has obviously changed. Due to the existence of the insulating layer, the electric field distribution between the wires is changed, and the capacitance parameters are changed. The configuration of the line segments is shown in Table 1. In addition, ATP-EMTP was used to calculate the parameters shown in Table 2.

As shown in Fig. 6, a high-frequency signal is injected at position 1, and the current at lines 632–645, 632–671, 632–633 are shown in Fig. 7. After injecting the signal, due to the blocking

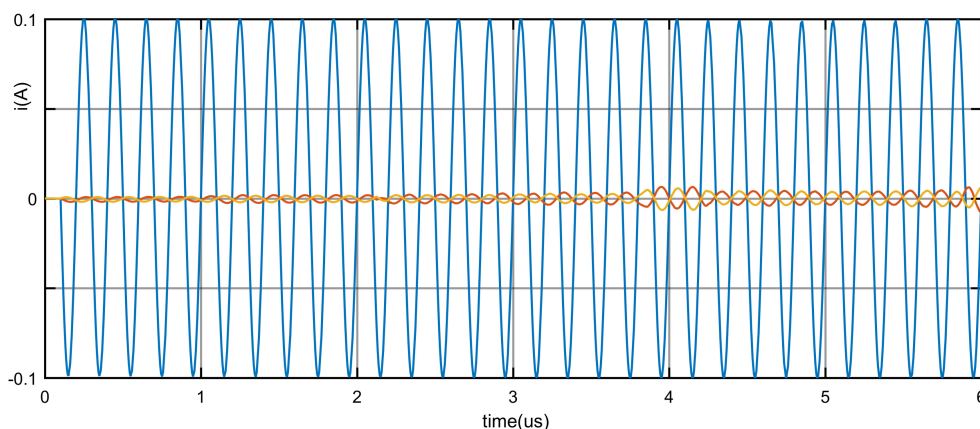
Fig. 7. Current i versus time on different feeders

effect of reactance, the influence of the high-frequency signal on other lines is relatively small, which can distinguish this line from other lines.

As shown in Fig. 8, the voltage detected at 23 places lags behind 10 cycles at 22 places, so it can be roughly inferred that the length of lines 632–671 is about 600 meters. In addition, the voltage at the observation point 22 changes obviously after 20 cycles, which can be inferred as a signal return. It can also be inferred that the length of the line is about 600 meters.

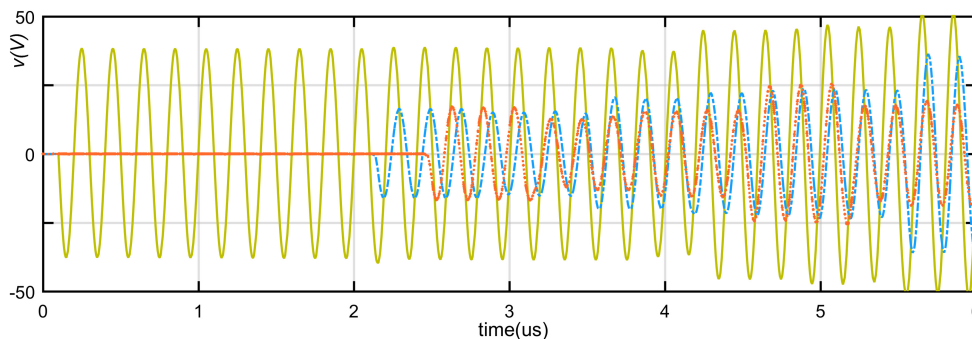

Fig. 8. Voltage on different positions

For the three-phase line section, a high-frequency signal is injected into the upstream of the single-phase line for identification. For single-phase lines, it is necessary to inject signals into three phases respectively to identify them. As shown in 684–611, in Fig. 6, a phase injection is required. The identification line section 684–652 needs to inject a signal into phase C.

6. Conclusions

By injecting a high-frequency signal into a low-voltage distribution line and using an inductor, the signal can propagate directionally along the line, which can be utilized for distribution line topology identification. The wavelength of a high-frequency signal is short. When the signal propagates along the line, it has obvious transmission line characteristics. By using the delay of signal transmission, the length of the outgoing line can be roughly calculated. The change of the line parameters will cause the signal to be reflected. The length of the new path can be approximately calculated by using the time delay of the signal reflection.

MATLAB is utilized to verify if the high-frequency injection signal can effectively identify the topology. In order to further verify the correctness of the method, laboratory physical tests are also required.

References

- [1] Thomas Allen Short, *Electric Power Distribution Handbook, Second Edition*, CRC Press (2014).
- [2] Kersting W., *Distribution System Modeling and Analysis, Fourth Edition*, CRC Press (2017).
- [3] Grotas S., Yakoby Y., Gera I. *et al.*, *Power Systems Topology and State Estimation by Graph Blind Source Separation*, IEEE Transactions on Signal Processing, vol. 67, no. 8, pp. 2036–2051 (2019).

- [4] Jun Jiang, Ling Liu, *Resonance mechanisms of a single line-to-ground fault on ungrounded systems*, Archives of Electrical Engineering, vol. 69, no. 2, pp. 455–466 (2020).
- [5] Fan Kaijun, Xu Bingyin, Dong Jun *et al.*, *Identification method for feeder topology based on successive polling of smart terminal unit*, Automation of Electric Power Systems, vol. 39, no. 11, pp. 180–186 (2015).
- [6] Zhu Guofang, Shen Peifeng, Wang Yong *et al.*, *Dynamic identification method of feeder topology for distributed feeder automation based on topological slices*, Power System Protection and Control, vol. 46, no. 14, pp. 152–157 (2018).
- [7] Li X., Poor H.V., Scaglione A., *Blind topology identification for power systems*, 2013 IEEE International Conference on Smart Grid Communications (SmartGridComm), IEEE, pp. 91–96 (2013).
- [8] Lazaropoulos A.G., *Measurement Differences, Faults and Instabilities in Intelligent Energy Systems—Part 1: Identification of Overhead High-Voltage Broadband over Power Lines Network Topologies by Applying Topology Identification Methodology (TIM)*, Trends in Renewable Energy, vol. 2, no. 3, pp. 85–112 (2016).
- [9] Lazaropoulos A.G., *Improvement of Power Systems Stability by Applying Topology Identification Methodology (TIM) and Fault and Instability Identification Methodology (FIIM) – Study of the Overhead Medium-Voltage Broadband over Power Lines (OVMV BPL) Networks Case*, Trends in Renewable Energy, vol. 3, no. 2, pp. 102–128 (2017).
- [10] Passerini F., Tonello A.M., *Power line network topology identification using admittance measurements and total least squares estimation*, 2017 IEEE International Conference on Communications (ICC), pp. 1–6 (2017).
- [11] Soumalas K., Messinis G., Hatziargyriou N., *A data driven approach to distribution network topology identification*, 2017 IEEE Manchester PowerTech, pp. 1–6 (2017).
- [12] Ge Haotian, Xu Binyin, *Topology Identification of Low Voltage Distribution Network Based on Current Injection Method*, Archives of Electrical Engineering, vol. 70, no. 2, pp. 297–306 (2021).