

Band Notch Characteristics Reconfigurable UWB Leaf Shape Monopole Antenna

Pachiyaannan Muthusamy, Srikanta Nallapaneni, Krishna Chaitanya Perumalla, and Bharghava Punna

Abstract—In this paper a band notch characteristics reconfigurable UWB leaf shape monopole antenna is reported. The proposed antenna size is $42 \times 32 \times 1.6$ mm³ and simulated S11 -10dB impedance bandwidth is from 2.1 to 13.0 GHz. The notch bands are embodied into the designed antenna to suppress Bluetooth and WiFi bands from 2.3-2.7 GHz and 4.6-5.3 GHz. The PIN Diode is loaded to slot on the DGS to achieve notch bands. It has 4.48dB and 1.7dB gain achieved when diode ON and OFF condition. Further, it encompasses a bio-inspired leaf shape patch having high feasibility for deployment in secret and military purposes.

Keywords—band notch; PIN diode; leaf shape monopole antenna; reconfigurable; UWB

I. INTRODUCTION

THE UWB technology has gained lot of popularity in the recent day advanced wireless communications due to its low cost, less complexity, large band-width and extremely high data transmission rate. In general UWB frequency band is wide frequency band and communication system utilized narrow band frequency band examples Bluetooth, Wimax, WLAN and C band frequencies, the band frequency are iMAX (802.16 3.30-3.70 GHz), C band(3.7-4.2GHz), WLAN (802.11 j/n 5.47-5.725 GHz, 5.725-5.825 GHz), ISM band (5.725-5.875 GHz), ITU(8.025-8.4 GHz) band, X satellite communication band(7.9-8.4 GHz). By avoiding mutual interference band notch characteristics introduced. To effectively utilize the entire ultra-wide band spectrum and in order to eliminate interference, a reconfigurable dual notch band characteristic with controlled band operation monopole antenna has been presented in this paper. For multiband, gain improvement and bandwidth enhancement the Defected ground structure(DGS) is reported in[1]. By modifying the ground structure the propagation properties i.e., current distribution change between ground and patch. The author has also showed different resonant structures used for DGS. The Defected Ground Structure and proved that an antenna with DGS results in good polarization and also reduced return loss. He also compared the results of flat ground antenna with DGS ground antenna. To transmit Morse code sequence across the Atlantic Ocean ultra-wide band technology was first used by Guglielmo Marconi in 1901 using the spark gap radio transmitters. But

UWB technology has gained a lot of popularity in the recent days due to its advantages. In paper [2] author presented a compact reconfigurable band notch characteristics WLAN and WiMAX circular UWB monopole antenna designed. In paper[3], the author presented coaxial connector different leaf shaped monopole antenna. In paper [4][5] reported cotton leaf and rose leaf geometry printed monopole antenna for UWB application. Similarly castor leaf-shaped quasi-self-complementary antenna is reported in [6]. The reconfigurable antennas have gained a lot of attention for their potential applications in devices with multiple wireless standards. Recently, various efforts, including theoretical and experimental studies have been made to realize additional performance enhancement by Reconfigurable antennas. The switchable operating frequency have the ability to accommodate new services according to the user utility and can cover multiple wireless standards. They can eliminate the sophisticated filter used in most of the wideband antennas. Among optical, electrical and mechanical techniques, the ease of integration, fast switching speed and high rate of repeatability make electrical tuning most preferable. The electrical method includes PIN diodes, varactor's and RF-MEMS as the switching elements, and each of these elements has its own advantages and limitations. A compact multi band notch characteristic reconfigurable UWB is reported in [7][8][9]. Author [10] [11] exhibited antenna with reconfigurability for applications such as Bluetooth and LTE has been proposed. Different antennas with re-configurability with different structures have been presented in works from paper [12-19]. There are different RF switch based reconfigurable antennas developed for UWB applications. The shape memory alloy, MEMS switch and PIN Diode concept implemented in [20-22]. Similarly, the various author discussed MEMS, PIN Diodes Varactor Diode based switch reconfigurable UWB antenna with notch reported in [23-30]. There are different industrialist and academic researcher involved to design reconfigurable antenna using various RF, MEME and varactor diode switch techniques. Based on the above literature author motivated design reconfigurable antenna for UWB applications and avoiding mutual inferences band notch concept introduced with help of PIN diode. The forthcoming section discuss about antenna design configuration, design steps, diode ON and OFF circuit parameters and antenna S parameter, Gain plot finally conclude the results.

Authors are with Department of Electronics and Communication Engineering, Advanced RF Microwave & Wireless Communication Laboratory, Vignan's Foundation for Science Technology and Research (Deemed to be University), Andhra Pradesh, India (e-mail: pachiphd@gmail.com, nsriphd@gmail.com, pkrishnachaitanya723@gmail.com, punnabharghava@gmail.com).



II. Antenna Design and Configuration

For designing a reconfigurable micro strip antenna, first select proper material for substrate. Here we have used FR4 ($\epsilon_r=4.4$) as the substrate. It is cost effective, has good electrical properties, manufacturability, performance and durability.

A. Initial Parameters of antenna

A leaf shaped ultra-wide band antenna is developed initially with substrate dimensions of $56 \times 46 \text{ mm}^2$ and thickness of 1.6 mm with a line feed. A portion of the ground is removed and a slot is made at the central part of the ground with dimension $3 \times 2.88 \text{ mm}^2$. The evolution of geometry of this basic design is shown in the Fig.1.

B. Evolution of design

The horizontal representation of the four antenna designs specify the evolution process from the basic design 1 with each stage incorporating an additional feature finally carving out design 4 with certain novel features which is shown in Fig.1.

Design 1 results in an ultra-band spread from 3-13 GHz with patch dimensions $24 \times 22.50 \text{ mm}^2$. Design 2 has an introduction of vertical slot in the ground and a visible change in the shape and dimension of the patch ($24 \times 30 \text{ mm}^2$). This slot disrupts the ultra-wide band spectrum by creating a notch at particular frequency acting as a stop band for that range of frequency and allowing the rest. To add re-configurability property i.e. switching between the two characteristics of with and without notch feature using PIN Diode between the slot as in design 2. Design 3 is slightly similar in functioning with design 2 with the alike vertical slot, but there is a clear demarcation due to shape and dimensional change $22 \times 25 \text{ mm}^2$ along with 5 additional slots introduced in the leaf shaped Patch. Thereby, the notch characteristics are produced at a different range of frequencies and also offer more improvement in the rest of UWB spectrum.

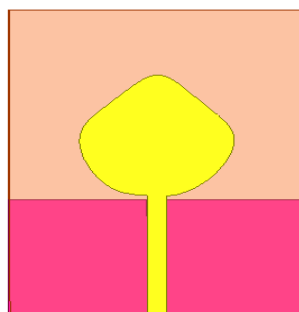

(a) Design 1

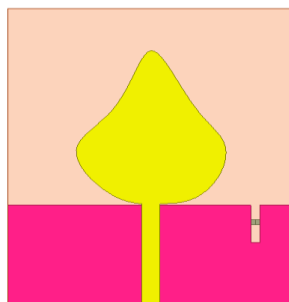

(b) Design 2

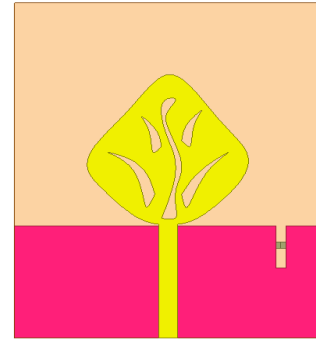

(c) Design 3

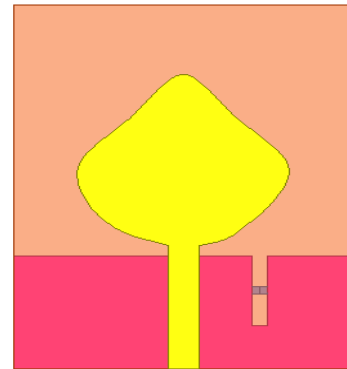

(d) Design 4 (proposed work)

Fig.1. Antenna Design Evolution

C. Configuration of Proposed antenna Design

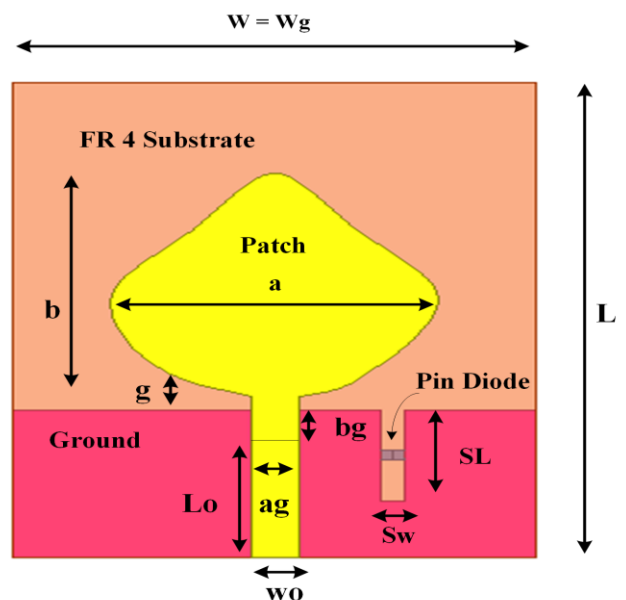

Fig.2. Proposed Antenna Design

Design 4 is the proposed model of Reconfigurable Ultra-wide band leaf shape antenna with notch band characteristics which is shown in Fig.2. One of the main objectives in achieving a better antenna design is size reduction without compromising on radiation and other parameters such as gain, return loss. So, a remarkable reduction of size of the substrate is achieved with

dimensions of the antenna $42 \times 32 \text{ mm}^2$ quantifying a 10 mm reduction in length and breadth each. Also, the position of vertical slot is changed with dimensions $8 \times 1.5 \text{ mm}^2$. The table includes the detailed dimensions of all the parameters in the final design. a and b are the horizontal and vertical diameter of the leaf respectively accounting to the dimension of patch as $20 \times 18 \text{ mm}^2$. g is the difference in length between the patch and defected ground which plays a key role in determining the ultra- wide band characteristics. The detailed dimension is reported in Table.1

The band notch is important for to eliminate frequency from wide-band behavior. Based on the below equation 1 and 2 calculate the notch frequency from length of patch element.

$$L_{\text{notch}} = c / 2f_{\text{notch}} \sqrt{\epsilon_{\text{eff}}} \quad (1)$$

$$\epsilon_{\text{eff}} \approx \epsilon_r + 1 / 2 \quad (2)$$

where, f_{notch} is the notch center frequency, L_{notch} is the slot length, c is the speed of light, ϵ_r is the dielectric constant of substrate, ϵ_{eff} is the effective dielectric constant.

TABLE I
DIMENSION OF PROPOSED ANTENNA

Parameter	Size in mm	Parameter	Size in mm
W=Wg	32	G	1.2
L	42	Ag	2.8
W0	2.8	Bg	3
L0	13	SL	8
A	20	SW	1.5
B	18	-	-

D. Reconfigurability and assigning values to PIN Diode

In all of the 3 designs except the first, reconfigurability property is incorporated under the idea of switching among frequencies. To achieve this property, we use the advantageous device PIN Diode. The structure shown in Fig.3(a) It has two conditions ON and OFF. Lumped element equivalent circuits of a PIN diode in forward-bias and reverse-bias conditions are shown in the Fig.3(b) when it is forward biased, it acts as (closed switch) a small resistance ($R_s=3 \Omega$) in series with a small inductance ($L=500\text{pH}$) and when reverse biased it acts as (open switch) a large resistance ($R_p=15 \text{ K}\Omega$) in parallel with a small capacitance ($C_p=32\text{fF}$) and in series with a small inductance ($L=500\text{pH}$). The PIN diode acts as small valued capacitor when DC bias applied to the diode. If diode is reverse biased small leakage occurring and behave as open switch. The circuit diagram of PIN diode is shown in Fig.3.

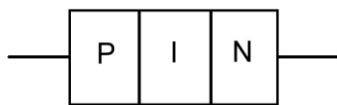

(a) PIN diode structure

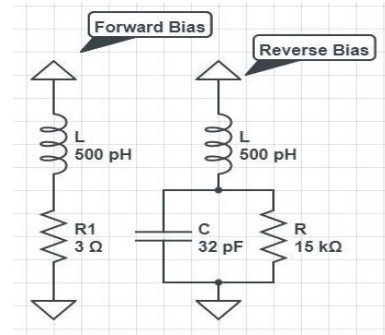

(b) Circuit Diagram of PIN Diode in Forward and Reverse Bias.

Fig.3 . PIN diode structure and Circuit Diagram

III. RESULTS AND DISCUSSION

In this section, it is explained the results of research and at the same time is given the comprehensive discussion. Results can be presented in figures, graphs and tables. The discussion can be made in several sub-chapters.

A. Design 1

This is a basic UWB antenna with no additional features. The return loss plot is shown in Fig.4 which observe that UWB band achieved but without ant notch characteristics.

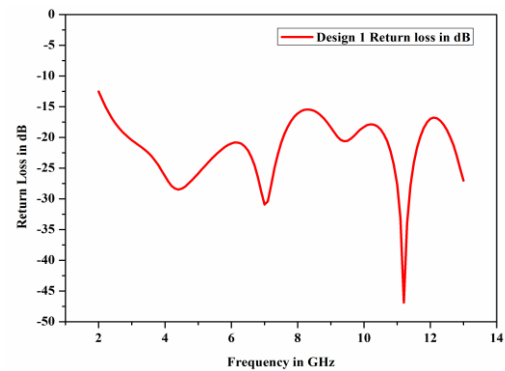

Fig.4. Return loss curve for Design -1

B. Design 2

This design involves a PIN Diode, the operation of reconfigurability is observed in ON and OFF conditions respectively. The return loss plot is shown in Fig.5.

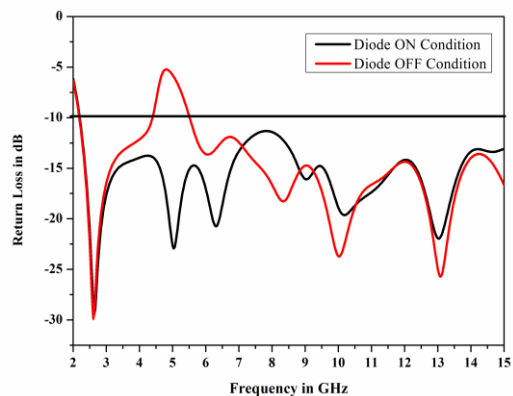

Fig.5. Return Loss curve for Design -2 in ON & OFF Condition.

C. Design 3

This design has 5 additional slots in the patch and also involves a PIN Diode, the operation of reconfigurability is to be observed in ON and OFF Conditions respectively. The blue graph indicates the Diode ON condition and is an UWB, while the red graph indicates the Diode OFF condition and a notch appears between 3.8-4.8 GHz. The gains of design 3 in ON and OFF conditions are 5.1 and 4.8 dB respectively. The return loss plot is shown in Fig.6.

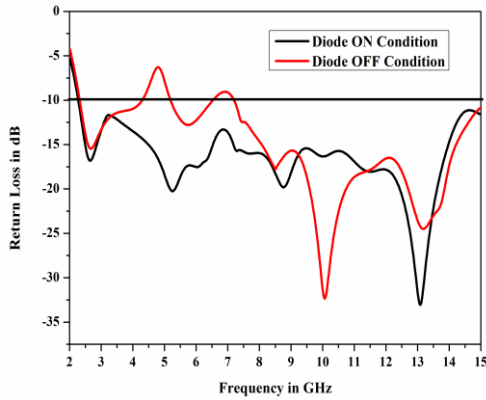

Fig.6. Return loss curve of Design 3 and indicating Notch between 3.8-4.8 GHz.

D. Design 4

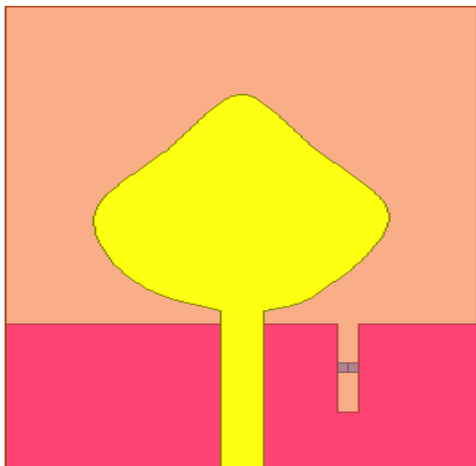

Fig.7. Design of Proposed structure

When the PIN diode is ON (forward biased), the slot made in the ground becomes practically inactive (no change in length) since, the PIN Diode acts as a conductor and makes the ground as a single structure with no significance for the slot. Here, we get an Ultra-wide Band. When the PIN Diode is OFF (reverse biased), the vertical slot in the ground as shown in the figure apparently gets activated (length varies) i.e. the influence of slot will be on current distribution and resonant frequency. Thereby, notches are produced. Interestingly, design 2 and 3 have a single notch but the final design offers two notches. The design of proposed structure shown in Fig.7 and return loss plot shown in Fig.8 for both PIN diode ON and OFF condition.

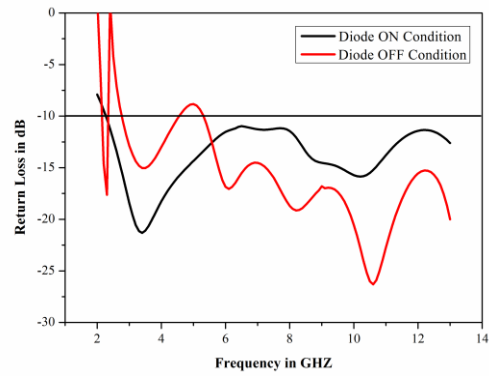

Fig.8. Return Loss curve for Design 4 in ON & OFF Conditions

The Case 1 PIN Diode ON- The green color plot represents the S Parameter plot in ON condition. It is clearly an Ultra-wide band covering the frequency range of 2-12 GHz. The case 2 PIN Diode OFF- The red color plot represents the S parameter plot in OFF condition. As per the operation of the PIN Diode the slot activated (length of conduction varies) and two notches at 2.3-2.7 GHz and 4.6-5.3 GHz appeared thus justifying reconfigurability. The return loss curve for design 4 in ON & OFF Conditions is reported in Fig 8, and radiation pattern of ON and OFF condition is shown in Fig.9 and 10, which is observed that similar to omni directional pattern and 3D Gain plot of both ON and OFF condition is shown in Fig.11 and 12. The gain value of ON and OFF condition is 4.48 dB and 1.7dB. The comparison parameter of evolution antenna with proposed antenna is reported in Table. 2.

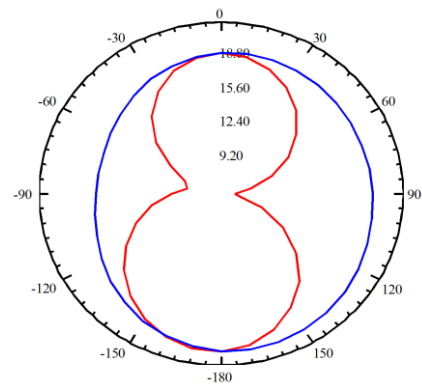

Fig.9. Radiation pattern of PIN Diode ON Condition

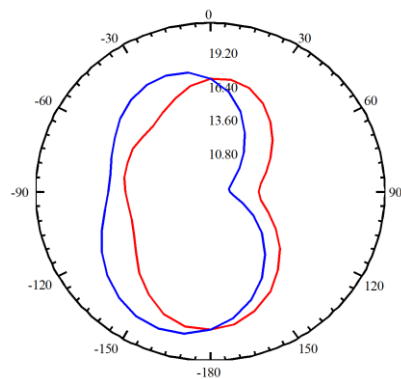

Fig.10. Radiation pattern of PIN Diode OFF Condition

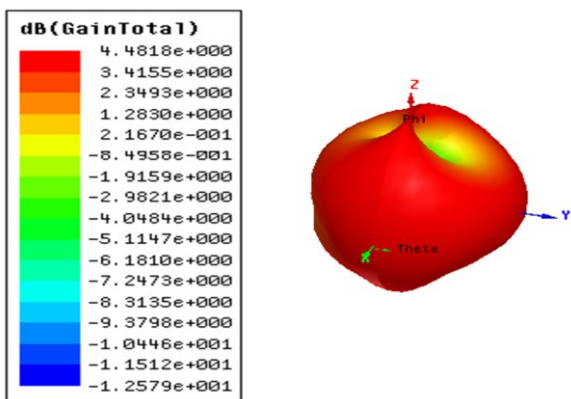

Fig.11. Gain Plot of the Design 4(ON Condition) 4.48 dB

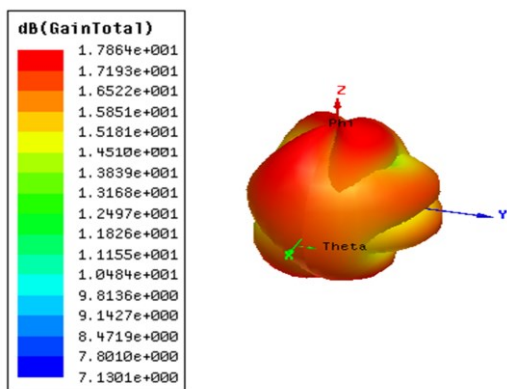

Fig.12. Gain Plot of the Design 4(OFF Condition) 1.7 dB

TABLE II

compariso n parameter of evolution antennaDes	Size in mm ²	Patch (Leaf) Dimensio n (axb)	Notch Band	Notch Bandwidth (GHz)
--	-------------------------	--	------------	-----------------------------

CONCLUSION

A reconfigurable Ultra-wide band leaf antenna has been designed, simulated and analyzed using HFSS. This proposed antenna size is 42 × 32 mm² and has been utilized FR4 substrate material. The simulated S11 returnloss -10dB impedance bandwidth is from 2.1 to 13.0 GHz and band notch characteristics from 2.3-2.7 GHz and 4.6-5.3 GHz. Reconfigurability has been achieved by etching a slot on the ground plane and using a switchable PIN Diode, without increasing the antenna size. The design has stable radiation characteristics and frequency reconfigurability with dual notch bands, and performance has been found satisfactory. The bio-inspired leaf shape design that can meet high-end applications has been developed. Further, in terms of functionality, the bandwidth of the rejection bands can be made more tunable for enhancing the performance.

ACKNOWLEDGEMENTS

We would like to acknowledge the Vignan’s Foundation for Science Technology and Research (VFSTR -deemed to be

ign Number				
1	56 x 46	24x22.5	-	-
2	56x46	24x30	Single	4.64-5.59
3	56x46	22x25	Single	3.8-4.8
4(Proposed work)	42x32	20x18	Dual	2.3-2.7 & 4.6-5.3

There are different researchers involved proposed reconfigurable antenna and based on the existing antenna performance comparison with proposed antenna is reported in table 3. In witnessed proposed antenna in terms overall size, ,no of notch band and bandwidth is good compared to existing work and proved that estimated design is very much essential and most suitable for UWB applications with notch characteristics.

TABLE III

COMPARISON PROPOSED ANTENNA WITH EXISTING ANTENNA

Design Number	Size in mm ²	Notch Band	Notch Bandwidth (GHz)
[16]	60x58	Dual	4.7-5.1 & 5.3-6.0
[13]	47x47	Dual	3.33-3.76 & 4.92-6.14
[17]	42x32	Dual	3.43-3.75 & 4.87-6.4
This work	42x32	Dual	2.3-2.7 & 4.6-5.3

university) and Ansys software company and, which has provided the Centre of Excellence (Keysight –Vignan’s Advanced RF Microwave and Wireless Communications) resources. This paper involved the HFSS Software extensively for the getting of simulations. We would like to thank the engineers and technicians of VFSTR and Ansys Software Company for their continual technical support during this paper.

REFERENCES

- [1] Khandelwal, Mukesh Kumar, Binod Kumar Kanaujia, and Sachin Kumar, “Defected ground structure: fundamentals, analysis, and applications in modern wireless trends,” *International Journal of Antennas and Propagation*, 2017. <https://doi.org/10.1155/2017/2018527>
- [2] De, Arnab, Bappaditya Roy, and Anup Kumar Bhattacharjee, “Design and investigations on a compact, UWB, monopole antenna with reconfigurable band notches for 5.2/5.8 GHz WLAN and 5.5 GHz Wi-MAX bands,” *International Journal of Communication Systems*, 2020. 33, e4323. <https://doi.org/10.1002/dac.4323>
- [3] Ozkaya, Umut, and Levent Seyfi., “A comparative study on parameters of leaf-shaped patch antenna using hybrid artificial intelligence network models,” *Neural Computing and Applications*, 2018, 29, pp.35-45. <https://doi.org/10.1007/s00521-016-2620-1>
- [4] de Moura, Leidiane CM, Josiel do N. Cruz, Andrécia P. da Costa, Paulo H. da F. Silva, and Jefferson C. e Silva., “UWB cotton leaf design

- microstrip-fed printed monopole antenna". *SBMO/IEEE MTT-S International Microwave and Optoelectronics Conference (IMOC)*. IEEE. 2015. pp. 1-4. <https://doi.org/10.1109/IMOC.2015.7369155>
- [5] Lotfi-Neyestanak and Abbas Ali. "Ultra wideband rose leaf microstrip patch antenna". *Progress In Electromagnetics Research*, 2008,86 , pp. 155-168. <http://doi.org/10.2528/PIER08090201>
- [6] Patre, Situ Rani, and S. P. Singh, "Castor leaf-shaped quasi-self-complementary antenna for broadband application". *2015 International Conference on Microwave and Photonics (ICMAP)*. IEEE. 2015, pp. 1-2. <https://doi.org/10.1109/ICMAP.2015.7408782>
- [7] Han, Liping, Gen Cheng, Guorui Han, and Wenmei Zhan. "Reconfigurable ultrawideband monopole antenna with single, dual, and triple band notched functions". *International Journal of RF and Microwave Computer Aided Engineering*, 2019, 29, e21837. <https://doi.org/10.1002/mmce.21837>
- [8] Ojaroudi, Nasser, and Mohammad Ojaroudi. "A novel design of reconfigurable small monopole antenna with switchable band notch and multi resonance functions for UWB applications". *Microwave and Optical Technology Letters*, 55, 2013 pp.652-656. <https://doi.org/10.1002/mop.27376>
- [9] Srivastava, Gunjan, Santanu Dwari, and Binod Kumar Kanaujia. "A compact UWB antenna with reconfigurable dual notch bands". *Microwave and Optical Technology Letters*, 57, 2015, pp. 2737-2742. <https://doi.org/10.1002/mop.29424>
- [10] Alam, Md Shahidul, and Amin Abbosh. "Reconfigurable band-rejection antenna for ultra-wideband applications". *IET Microwaves, Antennas & Propagation*, 12, 2017 pp.195-202. <https://doi.org/10.1049/iet-map.2017.0442>
- [11] Sharma, Manish, Yogendra Kumar Awasthi, and Himanshu Singh. "Compact multiband planar monopole antenna for Bluetooth, LTE, and reconfigurable UWB applications including X-band and Ku-band wireless communications". *International Journal of RF and Microwave Computer Aided Engineering*, 2019. 29, e21668. <https://doi.org/10.1002/mmce.21668>
- [12] Magray, M. Idrees, Khalid Muzaffar, Zamir Wani, Rajesh K. Singh, G. S. Karthikeya, and Shibani K. Koul. "Compact frequency reconfigurable triple band notched monopole antenna for ultrawideband applications". *International Journal of RF and Microwave Computer Aided Engineering*, 2019,29, e21942. <https://doi.org/10.1002/mmce.21942>
- [13] Ojaroudi, Sajjad, Yasser Ojaroudi, and Nasser Ojaroudi. "Novel design of reconfigurable microstrip slot antenna with switchable band notched characteristic". *Microwave and Optical Technology Letters*, 2015,57, pp. 849-853. <https://doi.org/10.1002/mop.28980>
- Sun, Xiaolei L., S. W. Cheung, and T. I. Yuk. "Generating a reconfigurable notch band for planar UWB monopole antennas". *Microwave and Optical Technology Letters*, 2013, 55, pp. 2906-2910. <https://doi.org/10.1002/mop.27968>
- [14] Tripathi, Shrivishal, Akhilesh Mohan, and Sandeep Yadav. "A compact fractal UWB antenna with reconfigurable band notch functions". *Microwave and Optical Technology Letters*, 2016, 58, pp.509-514. <https://doi.org/10.1002/mop.29609>
- [15] Lakrit, Soufian, Sudipta Das, Ali El Alami, Debaprasad Barad, and Sraddhanjali Mohapatra. "A compact UWB monopole patch antenna with reconfigurable Band-notched characteristics for Wi-MAX and WLAN applications". *AEU-International Journal of Electronics and Communications*, 2019,105,pp.106-115. <https://doi.org/10.1016/j.aeue.2019.04.001>
- [16] Abolfazl Falahati, and R. M. Edwards. "A novel compact fractal UWB antenna with triple reconfigurable notch reject bands applications". *AEU-International Journal of Electronics and Communications*, 2019, 101, pp.1-8. <https://doi.org/10.1016/j.aeue.2019.01.018>
- [17] Rajeshkumar, V., and S. Raghavan. "A compact metamaterial inspired triple band antenna for reconfigurable WLAN/WiMAX applications". *AEU-International Journal of Electronics and Communications*, 2015,69, pp.274-280. <https://doi.org/10.1016/j.aeue.2014.09.012>
- [18] Naser Moghadasi, Mohammad, Mohammad Reza Haraty, Seyed Majid Seyed Momeni, and Bal S. Virdee. "Novel compact UWB antenna with reconfigurable dual band notches using pin diode switches actuated without $\lambda/4$ DC bias lines". *Microwave and Optical Technology Letters*, 2012. 54, pp. 2392-2397. <https://doi.org/10.1002/mop.27066>
- [19] L. Sumana, E. F. Sundarsingh, and S. Priyadarshini, "Shape memory alloy-based frequency reconfigurable ultrawideband antenna for cognitive radio systems," *IEEE Trans. Compon., Packag., Manuf. Technol.*, vol. 11,no. 1, pp. 3–10, Jan. 202. <https://doi.org/10.1109/TCPMT.2020.3042738>
- [20] K. Sharma, A. Karmakar, M. Sharma, A. Chauhan, S. Bansal, M. Hooda, S. Kumar, N. Gupta, and A. K. Singh, "Reconfigurable dual notch band antenna on Si-substrate integrated with RF MEMS SP4T switch for GPS, 3G, 4G, bluetooth, UWB and close range radar applications," *AEU Int.J. Electron. Commun.*, vol. 110, pp. 1–9, Oct. 2019. <https://doi.org/10.1016/j.aeue.2019.152873>
- [21] S. Lakrit, S. Das, A. El Alami, D. Barad, and S. Mohapatra, "A compactUWB monopole patch antenna with reconfigurable band-notched characteristics for Wi-MAX and WLAN applications," *AEU Int. J. Electron. Commun.*, vol. 105, pp. 106–115, Jun. 2019. <https://doi.org/10.1016/j.aeue.2019.04.001>
- [22] B. Kim, R. Bairavasubramaian, S. Nikolaou, Y. S. Kim, J. Papapolymerou, and M. M. Tentzeris, "A novel single-feed circular microstrip antenna with reconfigurable polarization capability," *IEEE Trans. Antennas Propag.*, vol. 56, no. 3, pp. 630–638, 2008. <https://doi.org/10.1109/TAP.2008.916894>
- [23] B. R. Holland, R. Ramadoss, S. Pandey, and P. Agrawal, "Tunable coplanar patch antenna using varactor," *Electron. Lett.*, vol. 42, no. 2, pp. 319–321, 2006. <https://dx.doi.org/10.1049/el:20063554>
- [24] Y. J. Sung, "Simple tunable dual-band microstrip patch antenna," *Electron. Lett.*, vol. 45, no. 13, pp. 666–667, 2009. <https://dx.doi.org/10.1049/el.2009.0504>
- [25] Z. H. Hu, P. S. Hall, J. R. Kelly, and P. Gardner, "UWB pyramidal monopole antenna with wide tunable band-notched behavior," *Electron. Lett.*, vol. 46, no. 24, pp. 1588–1590, 2010.
- [26] D. Peroulis, K. Sarabandi and L. P. B. Katehi, "Design of reconfigurable slot antennas," *IEEE Trans. Antennas Propag.*, vol. 53, pp. 645–654, 2005. <https://doi.org/10.1109/TAP.2004.841339>
- [27] J. Perruisseau-Carrier, P. Pardo-Carrera, and P. Miskovsky, "Modeling, design and characterization of a very wideband slot antenna with reconfigurable band rejection," in *IEEE Trans. Antennas Propag.*, vol. 58, no. 7, pp. 2218–2226, 2010. <https://doi.org/10.1109/TAP.2010.2048872>
- [28] E. Antonino-Daviu, M. Cabedo-Fabres, M. Ferrando-Bataller, and A. Vila-Jimenez, "Active UWB antenna with tunable band-notched behavior," *Electron. Lett.*, vol. 43, no. 18, pp. 959–960, 2007. <http://dx.doi.org/10.1049/el:20071567>
- [29] W.-S. Jeong, D.-Z. Kim, W.-G. Lim, and J. W. Yu, "Tunable bandnotch ultra wideband planar monopole antenna using varactor," *Microw. Opt. Technol. Lett.*, vol. 51, no. 12, 2009.