



# Procedure for detoxication of linuron contaminated soil based on ozonation and fluidization process

Radosław Józefczyk<sup>1</sup>, Piotr Antos<sup>2</sup>, Marcin Pieniążek<sup>1</sup>, Maciej Balawejder<sup>1\*</sup>

<sup>1</sup>University of Rzeszów, Poland

<sup>2</sup>Rzeszow University of Technology, Poland

\*Corresponding author's e-mail: [mbalawejder@ur.edu.pl](mailto:mbalawejder@ur.edu.pl)

**Keywords:** linuron degradation, soil contamination, detoxication, earthworms, *Eisenia foetida*

**Abstract:** The linuron contaminated soil was subjected to remediation using ozone as an oxidant. The experiments were performed both in laboratory and pilot plant installations. Kinetics of linuron degradation was determined for both systems. Moreover, main linuron metabolites were identified, and possible degradation pathway was proposed. The soil remediation was found to be successful, which was verified by chemical and biological tests. The half-life time of linuron in the pilot scale installation was no more than 7.5 h. To verify the efficiency of soil detoxification, a toxicity test was performed, which utilized *Eisenia foetida* earthworm. The test organisms were exposed for 14 days to the linuron contaminated soil prior and after the remediation procedure. It was observed that in the control group and the group of organisms exposed to the ozonated soil, the survivability was 100%, whereas the earthworms exposed to the linuron contaminated soil that was not ozonated did not survive at all.

## Introduction

Linuron (3-(3,4-dichlorophenyl)-1-methoxy-1-methylurea) is an example of an urea-based herbicide. It has been in use since 1966, when it was firstly registered as a pesticide. It is an odorless, colorless solid crystal, characterized by a good solubility in water, and to some extent in other solvents. In soil environment, linuron is moderately persistent, its half-life in soil can reach from 37 to 67 days (Buleandra et al., 2019; Spirhanzlova et al., 2017; Swarczewicz et al., 2013).

Although in the European countries Linuron was banned in 2017, there are still locations in the world, e.g., Cameroon, where this particular pesticide is the source of contamination and presents risk to soil organisms including microorganisms and cultivated plants, which results in significant impact on soil fertility (Assokeng 2021).

Linuron is considered as a possible threat to ground water by the United States Environmental protection Agency (US EPA – Spirhanzlova et al., 2017). Therefore, a number of experiments have been made for the removal of linuron from aqueous solutions, e.g., electrochemical degradation (Abu Ghalwa et al., 2016), photocatalytic degradation (Fenoll et al., 2013), ultrasound assisted photo-fenton (Katsumata et al., 2011), catalytic ozonation (Rosal et al., 2010) UV irradiation, ozonation or a mixed process (Rao and Chu 2010).

However, the primary source of water contamination is the application of pesticides directly to crops where they are taken up by targeted and non-targeted organisms, or they can

be absorbed by soil components or undergo transformation into other compounds which may be even more toxic (Brachańska et al., 2020). In the literature, there are no reports on the procedures for remediation of linuron contaminated soil, however, it is possible to treat linuron contaminated soil with a variety of remediation methods, that were successfully utilized in cases of other toxic agents, including oxidation using ozone alone or hydroxyl radicals (Antos et al. 2012; Balawejder et al. 2014; Balawejder 2016a,b) or photocatalytic degradation (Quan et al., 2005).

Ozone is an allotropic form of oxygen whose molecules consist of three atoms. It is a very potent oxidant that was successfully utilized in various decontamination procedures ranging from sewage treatment to food protection. Ozone molecules may react directly with targeted compounds or can act indirectly as they may as well be responsible for generation of highly reactive hydroxyl radicals that in turn react with the targeted compounds, which is an indirect route of oxidation. Though, feeding of the oxidants to soil results in a problem with mass transfer limitations during the degradation procedure. That problem can be overcome by use of fluidized bed technology to provide optimal conditions for mass transfer (Balawejder 2016a,b).

The progress of linuron degradation in soil matrix can be monitored by chemical analysis. However, in order to unequivocally verify the efficacy of utilized soil detoxication procedure the results of chemical analysis should be supplemented with the measurement of stress caused by a toxic factor. Such a method should give reliable information about

acute toxicity, but also a more subtle data on the impact of toxic factors on living organisms.

A standard recommendation of OECD for determination of acute toxicity of chemical agents in soil is a test using *Eisenia fetida* or *Eisenia Andrei* as a test organism (OECD, 1984; Sforzini et al., 2015). Earthworms are good test organisms due to their large availability in the environment as well as favorable characteristics, i.e., short life cycle, high reproductive rate and ease of breeding. This enables precise manipulation of breeding conditions and utilization of populations of known age and history (Lowe et al, 2005, Lowe et al, 2007). The test recommended by OECD allows for the determination of LC<sub>50</sub> (lethal concentration, 50%).

Chronic toxicity can be determined by the utilization of reproductive toxicity test. In particular, the count of cocoons is the parameter that is most used for this purpose (OECD, 2004).

Although changes on the population level, i.e., organisms weight (Liu et al., 2020), lethality or reproductive disorders are good indicators that reveal any toxic properties of particular pollutants towards soil organisms, it should be considered that the first changes, if any, which occur in any living organisms can be observed on the sub cellular level (Sforzini et al., 2015). Therefore, a sub cellular assessment of environmental burden gives an early insight into sub lethal changes within indicator organism.

Biomarkers are an important tool for the assessment of various effects of chemicals on organisms in the environment. They can integrate chemical observations and the corresponding environmental response. This allows for the assessment of environmental pressure on the ecosystems in polluted areas (Svendsen et al 2004).

A simple and successful approach allowing the determination of chronic toxicity is a biochemical assay that originates from ecotoxicology. The neutral red retention time assay (NRR-t) is a method based on the measurement of the retention of a microscopic dye (the neutral red) in lysosomes of the organisms that were exposed to a xenobiotic agent. This is a nonspecific assay that was introduced for the first time as an indicator of the condition of sea ecosystem using *Bivalvia* as test subjects (Moore et al., 1976). This test was later successfully transferred to soil environment, where response of earthworms to the presence of heavy metals and various organics in soil was analyzed (Svendsen et al., 1996; Svendsen et al., 2004; Hankard et al., 2004; Sforzini et al., 2015; Boughattas et al., 2016; Zhao et al., 2021).

Taking the mentioned methods into consideration, it seems reasonable to use an acute toxicity test known from the OECD recommendation and enhance it with the biochemical assay based on the measurement of NRR-t.

The great advantage of the utilization of lysosomal membrane stability as a biomarker for toxic impact of chemical pressure on environmental biota is that it is a simple assay, that can be used as a nonspecific indicator for various types of pollutants. Also neutral red retention time (NRR time) can reveal complex effects of pollutants even when each of particular compounds is below detection limits. Furthermore, measurement of lysosomal membrane stability is a validated method that is nonspecific (Svensen et al., 1996).

In the presented research the soil contaminated with linuron was exposed to ozone treatment using a laboratory and a pilot scale fluidized bed reactors. To verify the efficiency of

remediation, chemical method based on extraction and GC-MS analysis was supplemented by research method involving test organism *Eisenia Foetida*.

## Materials and methods

### Chemicals

Linuron was obtained from CIECH S.A. (Sarzyna, Poland), acetone (pure p.a.) used for the extraction procedure was obtained from (Chempur Piekary Śląskie, Poland), and dichloromethane (pure p.a.) was supplied by Chempur (Piekary Śląskie, Poland). Anhydrous magnesium sulfate, potassium chloride, sodium chloride (all pure p.a.), ethanol with 96% purity, EDTA, solution of potassium dichromate in sulfuric acid and Mohr's salt from POCH S.A (Gliwice, Poland) were utilized. Silver sulphate, dimethyl sulfoxide (DMSO), neutral red chromotropic acid, phosphate-buffered saline (PBS) and ortho-phenanthroline were purchased from Sigma-Aldrich. Phosphate buffer for pH-metric analysis at pH 7.0 and salt concentration of 3.54 g/l KH<sub>2</sub>PO<sub>4</sub> and 14.7 g/L Na<sub>2</sub>HPO<sub>4</sub> was obtained from Scharlau.

### Analytical devices

For the determination of pesticide concentration and detection of their metabolites in soil, Varian GC-450 chromatograph coupled with mass spectrometer MS-240 (Santa Clara, CA, USA) was used. The analysis of the degradation processes of linuron was carried out on a capillary column 30 × 0.25 × 0.39 – L (m) × ID (mm) × OD (mm), stationary phase: VF-17ms, film thickness 0.25 μm. Temperature of the column oven was 50–300°C, with 10°C/min temperature gradient (20 min isotherm at 300°C). The 1079 PTV injector was used (split ratio 1:5), temperature of injection was 200°C, injection volume was 1 μL. The MS detector settings were: scan mode 50–500 m/z. Gas flow rate was 1 mL/min (He).

### Fluidized bed reactor

A laboratory scale reactor allowing for the remediation of 200g of pesticide active ingredient spiked soil (the acetone solution of active ingredient was used) was fed with ozone generated from ambient air. The device had been earlier used for remediation of the DDT contaminated soil (Balawejder et al., 2014), however, in the case of remediation of linuron contaminated soil, no source of water vapor was utilized (Balawejder et al., 2014). The device was scaled up and a pilot scale fluidized bed reactor (see Fig. 1) (reactor cross-section of 15 cm, load mass 3000g) was designed and constructed. The pilot scale device was filled with linuron spiked soil and later the detoxification procedure was launched. The reactor was fed with ozone generated from concentrated oxygen by a TS-30 ozone generator (Ozone Solutions, Hull, IA, USA) with maximal efficacy of 30 g O<sub>3</sub>/h. The ozone concentration in gas streams fed into both reactors was analyzed with a medium range Ozone Analyzer UV – 106M (0–1000 ppm) (Ozone Solutions, Hull, IA, USA) and was constant at 10 ppm.

### Determination of the linuron concentration in soil

The procedure for extraction of pesticides was analogous to that presented in (Balawejder et al. 2014). After extraction using acetone and methylene chloride, the samples were analyzed using Varian GC-450 chromatograph coupled with

mass spectrometer MS-240 (Santa Clara, CA, USA). The estimated limit of quantification (LOQ) was 1 mg/kg, and the limit of detection (LOD) was 0.03 mg/kg.

#### Determination of soil pH and nitrate ions concentration

Soil pH was measured using a CP-315 pH-meter. The analysis was conducted as follows. A soil suspension was prepared by mixing soil with demineralized water in mass ratio 1:5. Another soil suspension was prepared by mixing soil with a solution of 1 M KCl, in mass ratio 1:5. The measurement of pH was conducted after 24 hours of leaching, using a potentiometric method.

After ozonation, a 50 g soil sample was acquired from the reactor and mixed with 100 mL of deionized water. After 12 hours of stirring, the mixture was transferred into ion chromatograph Dionex ICS-1000, with a conductometric detector and a suppressor ASRS 300 4 mm to estimate the nitrate content. Analytes were separated on a IonPack AS14A 4×250 column and a IonPack AG14A 4×50 precolumn. The mobile phase contained 8 mM sodium carbonate and 1 mM hydro carbonate, flow rate: 1 mL/min.

#### Determination of TOC for the remediated soil

A 0.1 g of analyzed soil was weighed in a conical flask of 100 mL. Then, 10 mL of 0.068 M solution of potassium dichromate ( $K_2Cr_2O_7$ ) in sulfuric acid and 0.05 g of the  $Ag_2SO_4$  catalyst were added. Subsequently, the flask was heated up, and then kept at gentle reflux for 5 minutes. After cooling, the flask was cooled down to room temperature (25°C). The remaining

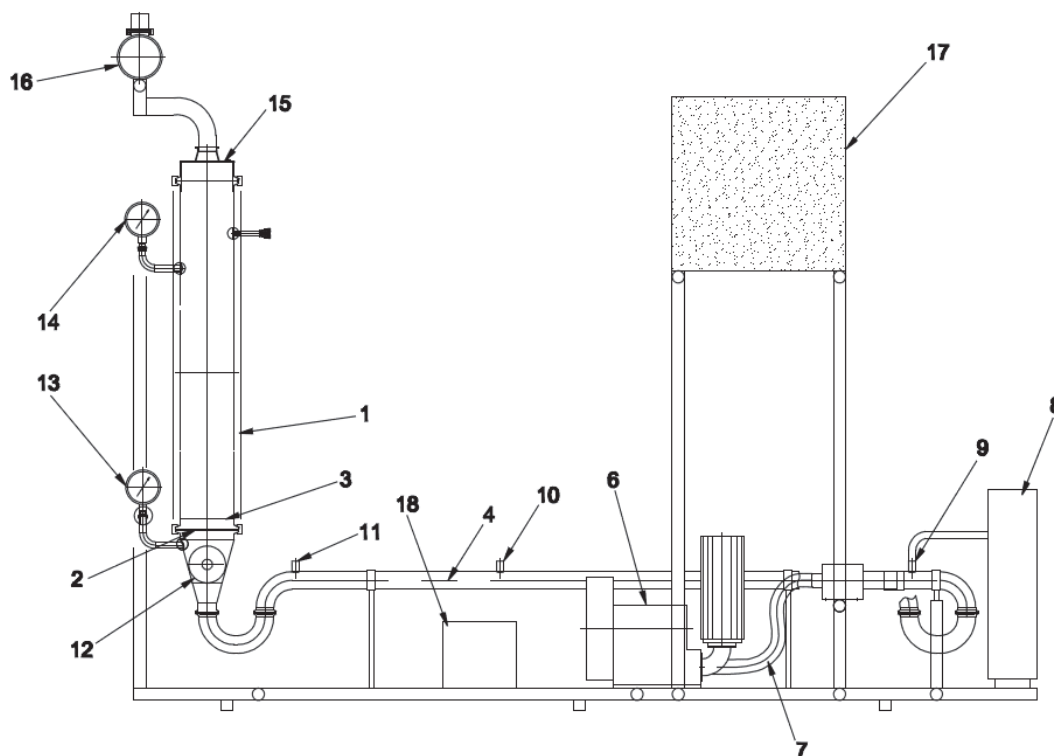
$K_2Cr_2O_7$  was titrated with 0.1 M solution of the Mohr's salt. As an indicator ortho-phenanthroline was used. On the basis of differences in the volumes of Mohr's salt used for titration of the blank and the test sample, the organic carbon content and organic matter in soil was determined.

#### Determination of possible changes of organic carbon forms within the soil

Prior to the determination of the presence of transformed organic carbon forms in soil, such as formaldehyde, a calibration curve was prepared. For this purpose, a volumetric flask with the volume of 1 L was filled with formalin that contained 1 g of formaldehyde. The flask was filled with distilled water, and then 10 mL of the solution was transferred into the 100 mL volumetric flask, and the flask was filled with distilled water. The final working solution contained 1 mg of formaldehyde in 1 mL. Next, 0.5 to 5 mL of the working solution was transferred into series of volumetric flasks with the volume of 100 mL and filled with distilled water. From each flask 1 mL sample was taken and mixed with 5 mL of sodium salt of chromotropic acid in sulfuric acid. The prepared mixture was heated in water bath at the temperature of 60°C for 20 min. Next, the mixtures were left at room temperature for cooling down for 1 hour. Finally, the absorbance of the solutions was measured for wavelength of  $\lambda = 565$  nm.

#### Breeding conditions of the test organisms

Toxicity tests were carried out using mature organisms of *Eisenia foetida* from breeding culture. A stock culture was held in plastic boxes with perforated cover. The soil environment



**Fig. 1.** Scheme of fluidized bed reactor: 1) reactor chamber, 2) wire netting supporting the bed, 3) bed (soil or other solid particles), 4) pipeline supplying the mixture of ozone and air to the reactor, 6) air pump, 7) pipeline connecting the pump with the installation, 8) ozone generator, 9) ozone inlet, 10) mass flow meter, 11) valve for monitoring the ozone concentration, 12) thermometer, 13, and 14) differential manometer, 15) outlet of the reactor chamber, 16) canister filled with activated carbon, 17) control device, 18) ultrasonic air humidifier (Balawejder 2016b)

consisted of the control or ozonated soil (prepared in accordance of OECD recommendations (Sforzini et al., 2015) and later spiked with linuron) mixed with a commercial flower bed and digested horse manure in proportions 1:1:1. The stock culture of earthworms was kept in a dark room at 20°C. The soil, in which the culture was kept, was moistured with distilled water.

#### **Exposition of test organisms on the contaminated soil**

The toxicity tests were carried out in the same room in plastic boxes with perforated cover. Into each box, 600 g of tested soil and 10 mature organisms were placed. Before transferring into the boxes, the earthworms were washed, dried on tissue-paper and weighed. The earthworms were fed at the start of the experiment and in 7th day of the experiment. Food consisted of 6 g of fermented horse manure moisture with 20 mL of water and wheat flour. After 14 days, the organisms that were exposed to the contaminated soil before and after the ozone treatment and also those taken from the control soil were counted and weighed. The average difference in mass of the organisms before and after they were subjected to the various soil types (control, contaminated and remediated) was determined. Additionally, for the organisms that had survived the experiments, the coelomocytes were collected to determine the amount of ameobocytes and eleocytes.

#### **Collection of coelomocytes**

The earthworms which were taken from the soil were washed and dried on tissue-paper. Next, they were placed onto the Petrie dish with 3 mL of the solution for suspending of coelomocytes that was prepared according to the procedure developed in (Weeks and Svendsen 1996). A solution consisted of 0.8 g NaCl, 0.27 g EDTANa<sub>2</sub>·2H<sub>2</sub>O, 5 mL of phosphate buffer at concentration 1.806% v/v? and distilled water that was used to fill up the volumetric glass with the volume of 100 mL. The coelomocytes were collected using a noninvasive method based on ejection of coelomic fluid through pores of the earthworm body due to electro shock caused by a battery that allowed for the generation of tension of 5 V. The collected celomocytes were instantly transferred onto microscopic glass for tests on NRR-t and Bürker hemocytometer.

#### **Counting of eleocytes and ameobocytes**

The Bürker chamber was utilized in order to count the amount of coelomic cells collected from the earthworms. The coelomocytes present in 10µl of the solution were transferred into the chamber by a semiautomatic pipette. Next the amount of ameobocytes and eleocytes was determined.

#### **Conducting of the test of the lysosomal membrane stability in earthworm coelomocytes**

The preparation of the neutral red, microscopic preparation and counting of dyed cells were conducted according to Svendsen et al., 1996. The observation and counting of the dyed cells were conducted after having taken photos with a camera.

#### **Preparation of the neutral red dye**

20 mg of neutral red dye was dissolved in 1 mL of DMSO. Next 10 µL of the prepared solution was dissolved in 2.5 mL of PBS

buffer. In such way, the prepared working solution of neutral red had a concentration of 80 µL/mL. To avoid crystallization of the neutral red dye, the solution was prepared separately for each test.

#### **Microscopic preparation**

A volume of 10 µL of coelomic fluid with coelomocytes was collected from Petri dishes using a semi-automatic pipette. The sample was then transferred onto the microscope slide. After 30 seconds, while coelomocytes were allowed to sediment and adhere to microscope slide, a 10 µL portion of neutral red solution was transferred onto the microscope slide to achieve a final dye concentration of 40 µg/mL. Next, the solution of coelomocytes and neutral red dye was covered with a coverslip. The preparation was then transferred into a higrstatic chamber. The chamber prevented the preparation from drying. On this stage, the dye was being absorbed by lysosomes of coelomocytes. From each individual earthworm organism, one or two preparations were prepared.

#### **Determination of the neutral red retention time**

During the microscopic analysis of the preparations, the coelomatic cells (both dyed and undyed) were counted. The observation was stopped as soon as 50% of coelomocytes got dyed with neutral red. Time that has passed since the addition of the dye till the end of the observation is considered the retention time of neutral red inside the lysosomes of the coelomocytes.

## **Results and Discussion**

#### **Degradation of linuron in soil**

The linuron contaminated soil was exposed to ozone in laboratory and pilot scale fluidized bed reactors. In the laboratory scale reactor, the soil was exposed to ozone generated directly from air, whereas the pilot scale installation was fed with ozone generated from oxygen. The exposition of linuron contaminated soil to ozone conducted in laboratory scale resulted in the reduction of over 90% of the initial linuron concentration (Fig. 2).

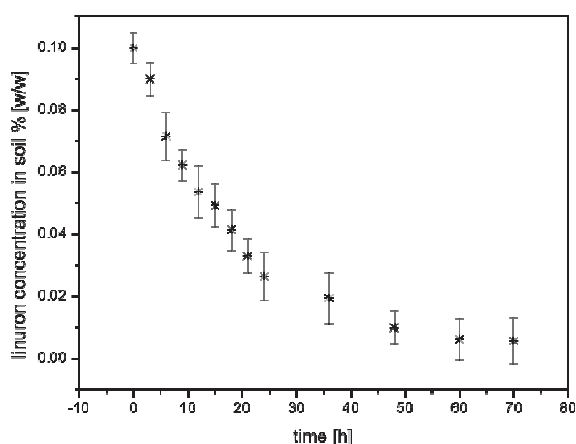
Positive results of the laboratory scale experiments were followed by a scaling up to pilot scale. The degradation kinetics is presented in Fig. 3.

To describe the course of the degradation process, pseudo first-order reaction kinetics was adopted (Figs 4 and 5), which is a common approach in the literature (Quan et al 2005). An almost linear correlation of  $\ln c/c_0$  versus time was observed for the degradation experiments both on the laboratory and pilot scale (Tab. 1).

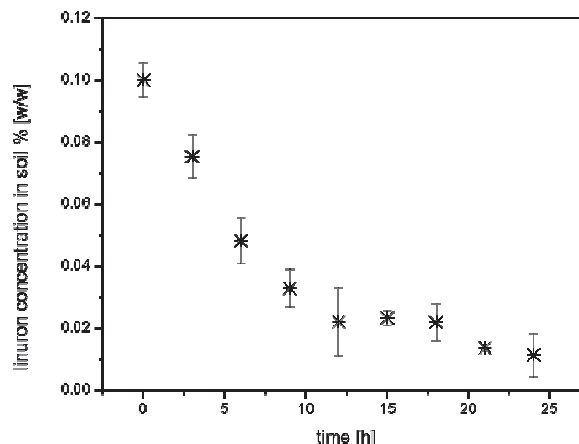
On the basis of the course of  $\ln c/c_0$  versus time, the reaction rate constant of the linuron degradation during ozonation in the laboratory and in pilot scale reactors and the half-life of the herbicide in soil during the process were calculated. The half-life of the linuron during the degradation experiments and under natural conditions are summarized in Table 1.

The differences in the half life time of linuron during remediation procedures result directly from the reactors construction. The reactor utilized in the pilot scale allowed for better conditions of fluidization process which resulted in better parameters of mass exchange and therefore shortened the reaction time.

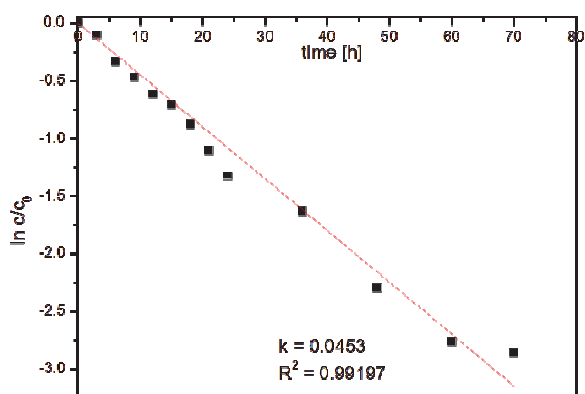




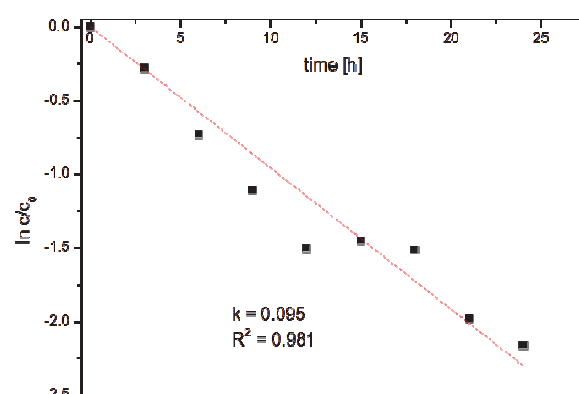
**Fig. 2.** Course of the linuron degradation conducted in the laboratory scale fluidized bed reactor. The results obtained are presented as a mean ( $\pm$ SD) from three independent experiments



**Fig. 3.** Course of the linuron degradation experiment conducted in the pilot scale fluidized bed reactor. The results obtained are presented as a mean ( $\pm$ SD) from three independent experiments.



**Fig. 4.** Determination of the reaction rate constant for the linuron degradation in the laboratory scale fluidized bed reactor



**Fig. 5.** Determination of the reaction rate constant for the linuron degradation in the quarter technical scale fluidized bed reactor

**Table 1.** Half-life time of linuron in soil exposed to the air and ozone mixture and in soil during natural degradation

Reactor type	Ozone concentration (ppm)	R <sup>2</sup>	Half-life time (h)
Laboratory	10	0.991	15.30
¼ technical	10	0.981	7.29
Natural degradation in soil	21–150 days		

### Degradation pathway of linuron during ozonation procedure

During the degradation process, a few metabolites of linuron were detected. Those products were: 3,4-dichloroaniline, 1,2-dichloro-4-nitro-benzene, and 4,5-dichloro-2-nitroaniline. Those chemical compounds appeared in a low concentration and subsequently underwent degradation (which is depicted in Fig. 6), therefore, the contaminated soil was efficiently purified.

The depicted changes in the values of the metabolites' concentrations during the ozonation process, are characteristic for the consecutive reactions. The analysis of the chemical structure of the degradation products detected during the ozonation of the linuron contaminated soil allowed for the

deduction of a possible pathway for the linuron degradation, which is presented in Fig. 7.

The first stage of the degradation process observed in laboratory scale reactor was linuron dealkylation, which led to the generation of (3,4-dichloroaniline). Another product of linuron transformation is 4,5-dichloro-2-nitroaniline, which presumably is generated due to impact of nitrogen oxides that are formed as a byproduct during the ozone generation from air. After scaling up the degradation procedure from laboratory to pilot scale, no degradation products were detected. Such an observation can indicate a more rapid linuron degradation in the case of the pilot scale reactor. On the other hand, the products identified during the ozonation of linuron contaminated soil in the laboratory scale reactor may be a result of the reactions

with the nitrogen oxides that were generated from ambient air during the ozone generation (Balawejder et al., 2016b). In the laboratory scale experiment the ozone was generated from air, whereas in pilot scale reactor, the ozone that was fed into the reaction chamber was generated from oxygen.

### Results of the investigations of soil characteristics before and after ozonation

To evaluate the impact of ozonation on the soil properties, pH of soil before and after the ozonation procedure was determined (see Table 2).

A possible cause of the reduction of the soil pH might be a result of transformation of soil organic matter. However, total organic carbon value was constant before and after the degradation experiments and it amounted 5% w/w. This observation excluded the losses of the organic carbon due to mineralization. However, the phenomena of the transformation of the organic carbon in other forms could not be excluded. It is known that as a result of ozonation of unsaturated compounds ozonides are generated. They then might decompose to aldehydes and ketones (Mussatto 2016). Indeed, as a result of the ozonation procedure of linuron contaminated soil, formaldehyde was generated. Its concentration was determined to be 20 mg in 1 kg of soil. The presence of this compound may pose a threat to living organisms, which was verified using of the *Eisenia fetida* earthworm. It should be noted that remedied soil kept organic carbon mostly in unchanged form. Due to a high concentration of Si, Al, and other elements, which are basic compounds in glass, waste such as contaminated soil, is a very good material for vitrification (Kuo and Wu 2021). Such a procedure results in transformation of toxic compounds in an anoxic environment. Thus, the formation of toxic metabolites, such as dioxins and furans, can be prevented. However, this method causes complete transformation of treated soil. This is not a desired effect from the agronomic perspective. Therefore, less destructive (in terms of preservation of soil properties) methods based on utilization of various oxidants may be more attractive. Moreover, thanks to fluidization there is better accessibility of ozone to treated soil matrix than in the case of in situ technologies. The efficacy of remediation technology was already tested with some harmful substances such as DDT or simazine.

The applied technology of fluidization coupled with ozonation is an emergency exit for soil detoxification in cases of heavy contamination occurring during accidents or inadequately protected disposals of hazardous waste. The proposed technology was initially developed in order to tackle the problem of burials in Poland where a number of insufficiently protected containers with the obsolete pesticides were kept in holes in soil, which often resulted in consecutive soil contamination. This problem was severe, in particular, in the case of pesticides with active ingredients characterized by a long half life time such as DDT. Similar level of contamination was achieved in soil as a result of illegal activity of Port Service company which was supposed to incinerate toxic waste but instead they disposed them nearby Gdansk in northern Poland. High concentration of pesticides, such as atrazine, were leaching to ground water posing a serious threat to local ecosystem. The applied technology is cheaper than incineration or vitrification, moreover it does not destroy the soil and leaves no residues as Fenton systems or utilization

of sorbents, due to ozone degradation into pure oxygen. Also although it is possible to abandon cultivation for several seasons in order to allow the pesticide to slowly dissipate, the acute toxicity may cause deaths of many organisms exposed to this agent. Abandoned soil where no cultivation takes place may still cause contamination of underground water.

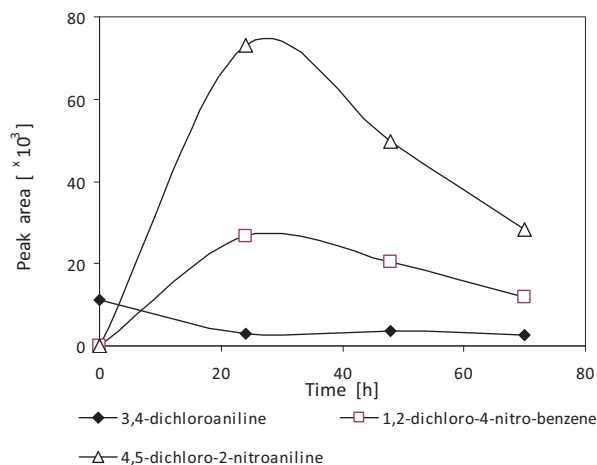


Fig. 6. Generation and degradation of linuron metabolites during the degradation procedure in laboratory scale reactor

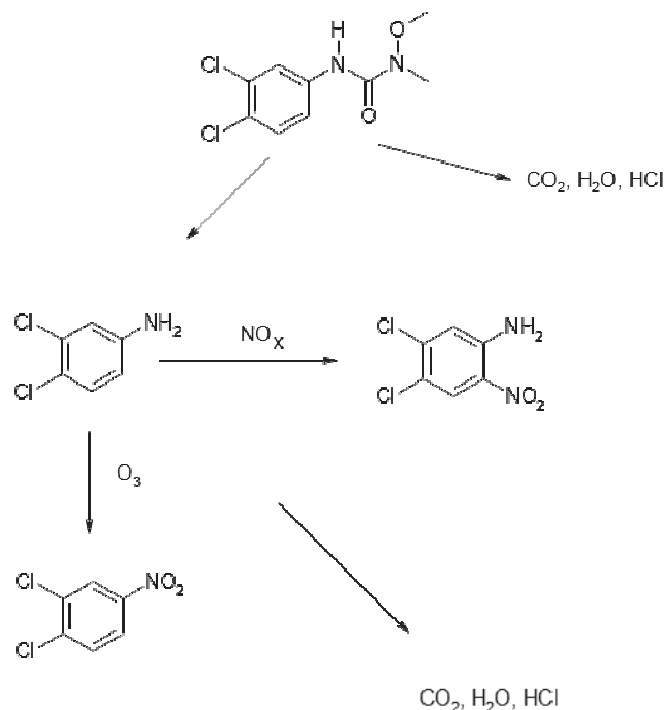


Fig. 7. Possible pathway of the linuron degradation in soil during the ozonation procedure

Table 2. Impact of ozonation on the soil pH and the nitrates concentration in soil

	Nitrates content [mg/L]	pH <sub>H2O</sub>	pH <sub>KCl</sub>
Soil before ozonation	109.88	7.13	6.52
Soil after ozonation	691.38	6.42	5.9

### Results of the tests on living organisms

Mature earthworms of *Eisenia fetida* species were exposed to control soil and soil contaminated with linuron before and after the remediation procedure. The control sample consisted of 10 mature organisms of *Eisenia fetida* not exposed to the pesticide. Each organism was weighed since the possible sublethal effects on earthworm conditions (Liu et al., 2020), coelomocytes were harvested, counted and the NRR-time was estimated. 40 organisms were exposed to the linuron contaminated soil (linuron concentration was 0.1% w/w) for 14 days. After a few days of exposition, symptoms of bad shape of the test organisms were observed. They were numb and showed limited reaction to mechanic stimulation with tweezers. The bodies of earthworms became thinner and, then the animals were fragmented and died. At the 7th day of exposition most of the earthworms population was dead and after 14th day no living organisms could be found. The results are illustrated in Fig. 8.

Due to a high degree of damage to the organism, the dead individuals were not extracted from the soil and therefore they

were not weighed. The experiment was repeated with another portion of test organisms (40 earthworms) and analogous results were observed.

The exposition of *Eisenia fetida* to the linuron contaminated soil after the remediation process resulted in an increase in the earthworm survival rate from 0 to 100%. Visual evaluation allowed us to conclude that the earthworms were in good shape, no body narrowing or numbness was observed. The survivability of the earthworms in the case of the control soil and the soil after the remediation procedure was 100%. The survivability of the earthworms that were exposed to the linuron contaminated soil was 0. The body mass of the earthworms exposed to the linuron contaminated soil after remediation was 6.6% higher than body mass of the same earthworms before they were exposed to the remediated soil (see Fig. 8). The number of coelomocytes and the estimated NRR-t before and after the remediation procedure is presented in Figs 9 and 10.

The mean value of coelomocytes count harvested from the control group of the earthworms was slightly higher than

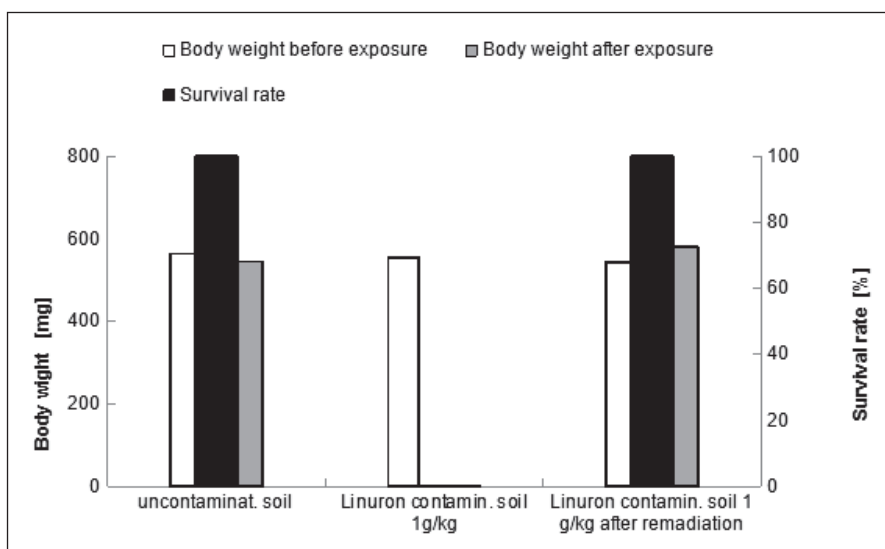


Fig. 8. Survival rate and body weight (mean  $\pm$  SD) of *Eisania fetida* before and after exposure to uncontaminated soil, soil contaminated with linuron and linuron contaminated soil after remediation

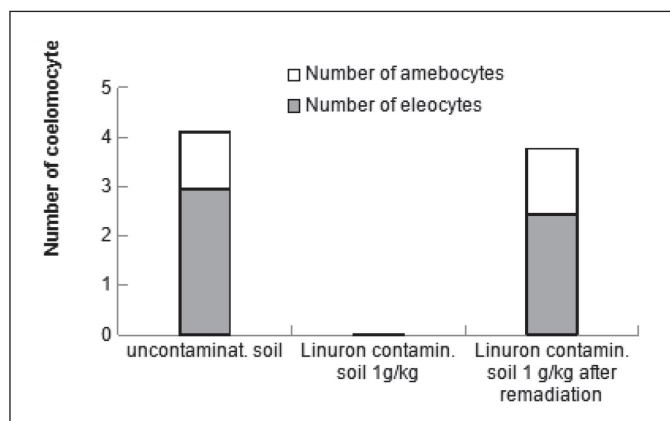


Fig. 9 The mean values ( $\pm$  SD) of count of coelomic cells harvested from *Eisenia fetida* exposed to uncontaminated soil, soil contaminated with linuron, and linuron contaminated soil after remediation

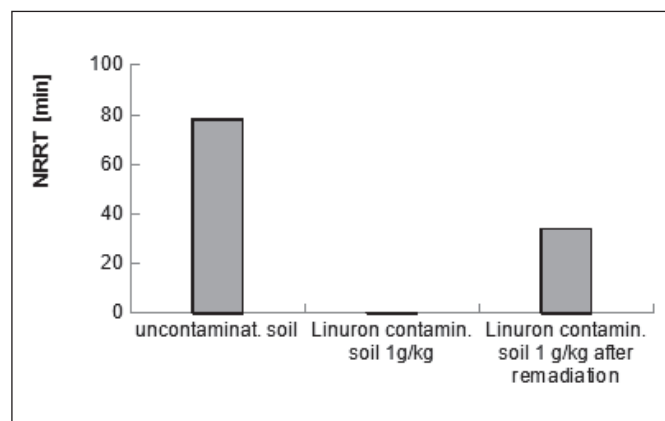


Fig. 10. The mean values ( $\pm$  SD) of neutral red retention time (min) of celomocytes harvested from *Eisenia fetida* exposed to uncontaminated soil, soil contaminated with linuron, and linuron contaminated soil after remediation.

the count of coelomocytes harvested from the organisms that were exposed to the linuron contaminated soil after the remediation procedure. Moreover, the proportion of eleocytes to amebocytes in both groups were different.

The mean value of the NRR-t observed in the control group was twice as long as the NRR-t observed in case of the earthworms exposed to linuron contaminated soil after the soil remediation process. This observation allows for drawing conclusion that the condition of the earthworms organisms exposed to the linuron contaminated soil after the ozonation procedure is worse than the condition of control organisms. An analogous observation was reported by Svendsen et al. 1996 where an increase of the xenobiotic concentration (cupper ions) resulted in the shortening of the neutral red retention time. Also in more recent studies by Zhao et al., 2021, a decrease of NRR-t in earthworm cells was observed after exposure to xenobiotic agent.

## Conclusions

Our experiments aimed at the determination of the efficacy of ozone treatment of linuron contaminated soil and at the evaluation of the impact of ozonation of the linuron contaminated soil on the *Eisenia foetida* earthworms. The conducted research involved laboratory and pilot scale soil remediation. It was observed that in the case of pilot scale reactor the pesticide degradation was more rapid and the half life time was between 7 and 8 hours. The possible pathway of linuron degradation in the case of laboratory scale device was proposed. The toxicity tests combined two approaches, e.g., the acute toxicity tests with ecotoxicity tests. It was shown that the remediation procedure has a positive impact on the quality of soil and thus *Eisenia foetida* earthworm health. The survivability of the test organisms in the control group and the group exposed to the soil after ozonation procedure was 100%, whereas the survivability of the organisms exposed to the linuron contaminated soil was 0. A more subtle tests, e.g., counting the coelomocytes and the measurement of the neutral red retention time showed a slight decrease of the earthworm condition within the contaminated soil after the ozonation procedure in comparison to control organisms. This may be a result of the transformation of organic carbon within the soil or an decrease of pH due to generation of nitrates. In general, it could be observed that the soil after ozonation was significantly less toxic than contaminated soil without remediation procedure.

## References

- Abu Ghalwa, N., Hamada, M., Abu Shawish, H.M. & Shubair O. (2016). Electrochemical degradation of linuron in aqueous solution using Pb/PbO<sub>2</sub> and C/PbO<sub>2</sub> electrodes. *Arabian Journal of Chemistry* 9, pp. 821–828, DOI: 10.1016/j.arabjc.2011.08.006
- Antos, P., Józefczyk, R., Kisała, J. & Balawejder, M. (2012). Remediation of imidacloprid contaminated soil – comparison of two different reactors for the ozone treatment. *Xenobiotics, Soil, Food and Human Health Interactions*, Rzeszów ISBN 978-83-7338-785-0, pp. 147–158
- Assokeng, T., Noumi, G.B., Adjia, H.Z. & Sieliechi, J.M. (2021). Assessment of the Risk of Contaminating Soil Cultivation Fruits and Vegetables by Linuron Residues in the Market Gardening Zone in Marza in Ngaoundere – Cameroon. *Resources and Environment* 11(1): pp. 1–8, DOI: 10.5923/j.re.20211101.01
- Balawejder, M., Antos, P., Czyjlit Kuryło, S., Józefczyk, R. & Pieniążek, M. (2014). A novel metod for remediation of DDT contaminated soil. *Ozone Science&Engineering*, 36, pp. 166–173, DOI: 10.1080/01919512.2013.861324
- Balawejder, M., Antos, P., Józefczyk, R. & Pieniążek, M. (2016a). A method for remediation of soil contaminated with simazine. *Archives of Environmental Protection*, 42(3), pp. 41–46, DOI: 10.1515/aep-2016-0024
- Balawejder, M., Józefczyk, R., Antos, P. & Pieniążek, M. (2016b). Pilot-scale Installation for Remediation of DDT-contaminated soil. *Ozone: Science & Engineering*, 38, pp. 272–278, DOI: 10.1080/01919512.2015.1136556
- Barchańska, H., Czaplicka, M. & Kyzioł-Komosińska, J. (2020). Interaction of selected pesticides with mineral and organic soil components. *Archives of Environmental Protection*, 46 (3), pp. 80–91, DOI: 10.24425/aep.2020.134538
- Boughattas, I., Hattab, S., Boussetta, H., Sappin-Didier, V., Viarengo, A., Banni, M. & Sforzini, S. (2016). Biomarker responses of *Eisenia andrei* to a polymetallic gradient near a lead mining site in North Tunisia. *Environmental Pollution*, 218 pp. 530–541, DOI: 10.1016/j.envpol.2016.07.033
- Buleandra, M., Popa, D.E., David, I.G., Bacalum, E., David, V. & Ciucu, A.A. (2019). Electrochemical behavior study of some selected phenylurea herbicides at activated pencil graphite electrode. Electrooxidation of linuron and monolinuron. *Microchemical Journal*, 147, pp. 1109–1116, DOI: 10.1016/j.microc.2019.04.042
- Fenoll, J., Martínez-Menchón, M., Navarro, G., Vela, N. & Navarro, S. (2013). Photocatalytic degradation of substituted phenylurea herbicides in aqueous semiconductor suspensions exposed to solar energy. *Chemosphere*, 91, pp. 571–578, DOI: 10.1016/j.chemosphere.2012.11.067
- Hankard, P.K., Svendsen, C., Wright, J., Weinberg, C., Fishwick, S.K., Spurgeon, D.J. & Weeks, J.M. (2004). Biological assessment of contaminated land using earthworm biomarkers in support of chemical analysis. *Sci. Total Environ.*, 330, pp. 9–20, DOI: 10.1016/j.scitotenv.2003.08.023
- Katsumata, H., Kobayashi, T., Kaneco, S., Suzuki, T. & Ohta, K. (2011) Degradation of linuron by ultrasound combined with photo-Fenton treatment. *Chemical Engineering Journal*, 166, pp. 468–473, DOI: 10.1016/j.cej.2010.10.073
- Kuo, S.L. & Wu, E.M.-Y. (2021). Remediation Efficiency of the In Situ Vitrification Method at an Unidentified-Waste and Groundwater Treatment Site. *Water*, 13, 3594, DOI: 10.3390/w13243594
- Liu, T., Liu, Y., Fang, K., Zhang, X. & Wang, X. (2020). Transcriptome, bioaccumulation and toxicity analyses of earthworms (*Eisenia fetida*) affected by trifloxystrobin and trifloxystrobin acid. *Environmental Pollution*, 265, Part B, 115100, DOI: 10.1016/j.envpol.2020.115100
- Lowe, C.N. & Butt, K.R. (2007). Earthworm culture, maintenance and species selection in chronic ecotoxicological studies: A critical review. *European Journal of Soil Biology*, 43, pp. 281–288, DOI: 10.1016/j.ejsobi.2007.08.028
- Lowe, C.N. & Butt, K.R. (2005). Culture techniques for soil dwelling earthworms: a review. *Pedobiologia*, 49 (5), pp. 401–413, DOI: 10.1016/j.pedobi.2005.04.005
- Moore, M.N. (1976). Cytochemical demonstration of latency of lysosomal hydrolases in the digestive cells of the common mussel, *Mytilus edulis*, and changes induced by thermal stress. *Cell. Tissue Res.* 175, pp. 279–287, DOI: 10.1007/BF00218706
- Mussatto, S.I. (2016). *Biomass Fractionation Technologies for a Lignocellulosic Feedstock Based Biorefinery*, ISBN 978-0-12-802323-5, pp. 410–411



- OECD Guideline For Testing Of Chemicals No. 207: Earthworm, Acute Toxicity Tests (*Eisenia fetida*/*Eisenia Andrei*), OECD 1984, DOI: 10.1787/9789264070042-en
- OECD Guideline For Testing Of Chemicals No. 222: Earthworm Reproduction Test (*Eisenia fetida*/*Eisenia Andrei*), OECD 2004 <https://www.oecd.org/env/ehs/testing/Draft-Updated-Test-Guideline-222-Earthworm-reproduction-Test.pdf>
- Quan, X., Zhao, X., Chen, S., Zhao, H., Chen, J. & Zhao, Y. (2005). Enhancement of p,p'-DDT photodegradation on soil surfaces using TiO<sub>2</sub> induced by UV-light, *Chemosphere*, 60, pp. 266–273, DOI: 10.1016/j.chemosphere.2004.11.044
- Rao, Y.F. & Chu, W. (2010). Degradation of linuron by UV, ozonation, and UV/O<sub>3</sub> processes – Effect of anions and reaction mechanism. *Journal of Hazardous Materials*, 180, pp. 514–523, DOI: 10.1016/j.jhazmat.2010.04.063
- Rosal, R., Gonzalo, M. S., Rodríguez, A., Perdigón-Melón, J.A. & García-Calvo, E. (2010). Catalytic ozonation of atrazine and linuron on MnOx/Al<sub>2</sub>O<sub>3</sub> and MnOx/SBA-15 in a fixed bed reactor. *Chemical Engineering Journal*, 165, pp. 806–812, DOI: 10.1016/j.cej.2010.10.020
- Sforzini, S., Moore, M.N., Boeri, M., Bencivenga, M. & Viarengo, A. (2015). Effects of PAHs and dioxins on the earthworm *Eisenia andrei*: A multivariate approach for biomarker interpretation. *Environmental Pollution*, 196 pp. 60–71, DOI: 10.1016/j.envpol.2014.09.015
- Svendsen, C., Spurgeon, D.J., Hankard, P.K. & Weeks, J.M. (2004). A review of lysosomal membrane stability measured by neutral red retention: is it a workable earthworm biomarker?. *Ecotoxicology and Environmental Safety*, 57, pp. 20–29, DOI: 10.1016/j.ecoenv.2003.08.009
- Svendsen, C., Meharg, A.A., Freestone, P. & Weeks, J.M. (1996). Use of an earthworm lysosomal biomarker for the ecological assessment of pollution from an industrial plastics fire. *Soil Ecology*, 3, pp. 99–107, DOI: 10.1016/0929-1393(95)00085-2
- Spirhanzlova, P., De Groef, B., Nicholson, F.E., Grommen, S.V.H., Marras, G., Sébillot, A., Demeneix, B.A., Pallud-Mothré, S., Lemkine, G.F., Tindall, A.J. & Du Pasquier, D. (2017). Using short-term bioassays to evaluate the endocrine disrupting capacity of the pesticides linuron and fenoxycarb. *Comparative Biochemistry and Physiology, Part C*, 200, pp. 52–58, DOI: 10.1016/j.cbpc.2017.06.006
- Swarcewicz, M., Gregorczyk, A. & Sobczak, J. (2013). Comparison of linuron degradation in the presence of pesticide mixtures in soil under laboratory conditions. *Environ Monit Assess*, 185, pp. 8109–8114, DOI: 10.1007/s10661-013-3158-7
- Zhao, S., Wang, Y. & Duo, L. (2021). Biochemical toxicity, lysosomal membrane stability and DNA damage induced by graphene oxide in earthworms. *Environmental Pollution*, 269, 116225, DOI: 10.1016/j.envpol.2020.116225

## Metoda oczyszczania gleby zanieczyszczonej linuronem poprzez ozonowanie w fazie fluidalnej

**Streszczenie:** Zanieczyszczoną linuronem glebę poddano remediacji z użyciem ozonu jako utleniacza. Eksperymenty przeprowadzono zarówno w instalacji laboratoryjnej, jak i instalacji pilotażowej. Dla obu systemów wyznaczono kinetykę degradacji linuronu. Ponadto zidentyfikowano główne produkty rozkładu linuronu i zaproponowano możliwy szlak degradacji. Remediacja gleby okazała się skuteczna, co zweryfikowano testami chemicznymi i biologicznymi. Okres półtrwania linuronu w instalacji w skali pilotażowej nie przekraczał 7,5 godziny. W celu sprawdzenia skuteczności detoksykacji gleby przeprowadzono test toksyczności, w którym wykorzystano dżdżownicę *Eisenia foetida*. Organizmy testowe były wystawione na działanie gleby skażonej linuronem przez 14 dni przed i po procedurze remediacji. Zaobserwowano, że w grupie kontrolnej i grupie organizmów narażonych na kontakt z glebą poddaną remediacji przeżywalność wyniosła 100%, natomiast dżdżownice narażone na kontakt z glebą skażoną linuronem nie przeżyły.