

An Interactive Graphical User Interface Module for Soldier Health and Position Tracking System

Wesam F. Swedan, Huthifa A. Al_Issa, Ayat Aloqoul, Hadeel Alkofahi, and Rahaf Obeidat

Abstract—Soldiers are the backbone of any armed force. They usually lose their lives due to the lack of medical assistance in emergency situations. Furthermore, army bases face problems due to the inability to track soldiers' locations in the field. Hence, this paper proposes an interactive graphical user interface module (IGUIM) for soldiers' bioinformatics acquisition and emergency reaction during combat, a global positioning system (GPS) is used to track soldiers' locations through a device carried by the soldier. Soldiers' bioinformatics are gathered using health monitoring biosensors, bidirectional communication between the soldiers and the army base is established via a global system for mobile (GSM). The proposed interactive module aims to enumerate the soldiers on the battlefield within a database that easily facilitates health monitoring, position tracking and bidirectional communication with each soldier through their identification number. The proposed IGUIM will increase the rate of soldiers' survival in emergencies, which contributes to preserving the human resources of the army during combat.

Keywords—graphical user interface; global positioning system; global system for mobile; bioinformatics; tracking system

I. INTRODUCTION

THE lives of soldiers are of great importance to the country and its security. This paper proposes an easy-to-use IGUIM for monitoring and tracking to preserve it. The tracking system uses a device that consists of vital sensors; which consist of a temperature sensor that measures the soldier's temperature, and a heart rate sensor. The proposed approach tracks the location of the soldier through GPS. It also allows the soldier to send a message to the army base in case of an emergency and enables the army base personal to send the closest possible aid to any soldier in need. This device also contains a GSM modem to provide wireless bidirectional communication between soldiers and the army base.

The proposed IGUIM-based soldier health and position tracking system design is cost-effective, reliable, and has the capability of accurate tracking. The main feature of the system is the interactive bidirectional communication between the army base and the mobile unit carried by the soldier, done with simple design and easy implementation. It is completely integrated so that once it is implemented it can be used by all soldiers. The tracking and navigation of soldiers, as well as their current health status during combat, will be displayed in the module's interface which was programmed using LabVIEW. The module's interface is located in the army's base control room, empowers army leaders to interact with various emergencies to take appropriate action and plan war strategies more efficiently.

The rest of the paper is organized as follows: Section II of the paper addresses research motivation and related work. The

problem statement is stated in section III, while the main components of the proposed system are introduced in section IV. Section V explains the research methodology and implementation. Section VI presents the proposed IGUIM. Section VII presents the research findings. Finally, section VIII provides the conclusion and future work.

II. RELATED WORK

During past wars, armies lost soldiers without knowing their fate due to difficulty in communicating with the army base, which led to considerable human and material losses. Soldiers can also be injured and sometimes lost during wars and military search operations. Lim et al. [1] discussed recent advances in various wearable, portable, lightweight and small sensors, that have been developed for monitoring of the human physiological parameters. Sailesh et al. [2] introduced a system that gives the ability to track soldiers at any moment and used a LabVIEW based interface for wireless interaction with soldiers. Also, Nikam et al. [3] introduced an idea for the protection of soldiers, through GPS based soldier tracking and health indication system with soldier information displayed using visual basic software on the computers at the base station, and Limbu and Kale [4] attempted to improve soldiers' communication with control room personnel and used visual basic 6.0 software in its base unit to monitor soldiers' status. Meerabi et al. [5] focused on tracking the location of soldiers using GPS and proposed the use of wireless bio-medical sensors as triggers for GSM to establish a connection with the base unit and to send the current location and health status to the receiver via an alert message. Ranjini et al. [6] introduced a system for monitoring the position of soldiers and their health status and any detected abnormalities are a trigger for GSM to send the soldier's information to the base unit. Cotton and Scanlon [7] proposed a methodology on the topic of millimetre-wave soldier-to-soldier communications for covert battlefield operation. Rantakokko et al. [8] suggested an approach on accurate and reliable soldier and first responder indoor positioning multi-sensor systems and cooperative localization. Pereira et al. [9] offered a method for modelling a multipath environment using copulas for particle filtering based on GPS navigation. Kumar and Vijay [10] planned a procedure on health monitoring and tracking of soldiers using GPS that can be used in critical conditions with their location displayed on a map at the base station. Serag et al. [11] designed a smart soldier health and location monitoring system using a web server user interface. Gondalia et al. [12] used the internet of things (IoT) and machine learning to monitor the health and position of soldiers.

All authors are with the Department of Electrical Engineering, Al-Huson University College, Al Balqa Applied University, Jordan (e-mails:

wesam76@bau.edu.jo, h.alissa@bau.edu.jo, ayataliayat2@gmail.com, hadeelalkofahi0@gmail.com, Rahaffobeidat1998@gmail.com).



III. PROBLEM STATEMENT

Many soldiers lost their lives due to the lack of aid in a timely manner. Also, the army bases are unable to determine the exact geographical location of soldiers during combat. Hence, this paper proposes an IGUIM at the army base that enables the remote monitoring of soldier bioinformatics for fast emergency response during combat and emergencies. GPS is used to track soldier locations and GSM is used to establish bidirectional communication between the soldiers and their commanders.

IV. PROPOSED SYSTEM DESIGN

The proposed system was designed using hardware components such as the Arduino NANO and MEGA [13–15], liquid crystal display (LCD) [16], bioinformatics such as heart rate sensor [17] and temperature sensor [18], as well as an interface that was programmed through LabVIEW language [19]. The system was divided into two units, the soldier mobile unit (SMU) and the monitoring station unit (MSU).

A. The soldier mobile unit

This is a mobile unit carried by the soldier and is composed by combining the following elements:

- 1) Microcontroller (Arduino Mega 2560) [20].
- 2) 16×2 LCD screen [21].
- 3) GSM-general packet radio service (GPRS) module (A6 GSM/GPRS Module) [22].
- 4) Mini GPS module (GY-NEOMV2 GPS module) [23].
- 5) Temperature sensor (MLX90614) [24].
- 6) Heart rate sensor (pulse sensor) [25].
- 7) Push Button [26].
- 8) Light-emitting diode (LED) [27].

In this unit, the soldier's vital information such as temperature and heart rate in addition to the soldier's location are collected. This information is sent periodically (at set intervals) to the army base that monitors the soldier's condition. In case of changes in a soldier's health status or an emergency, he can press a button that is on the device for help. Figure 1 below shows the block diagram that represents the SMU.

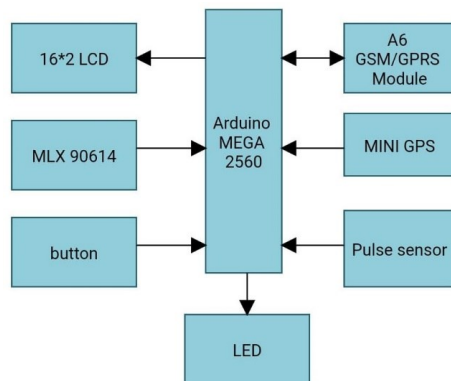

Fig. 1. The block diagram of the soldier mobile unit

B. The monitoring station unit

This unit is installed at the army base station and is built using the following parts:

- 1) Microcontroller (Arduino NANO) [28].
- 2) A6 GSM/GPRS Module [22].
- 3) Personal Computer (PC) [29].

In this unit, the soldier's health status and geographical location are monitored through the developed IGUIM. An

identification (ID) number is assigned for each soldier and this ID is associated with his vitals data and location tracking. The information is extracted and decoded by the IGUIM. Data is sent to the army base via GSM using an encrypted message from the SMU. This message includes the situation in which it was sent; an emergency (press of the emergency button) or normal periodical update. Figure 2 below shows the block diagram that represents the MSU.

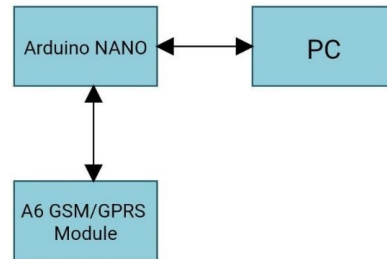

Fig. 2. The block diagram of the monitoring station unit

V. METHODOLOGY AND IMPLEMENTATION

Initially, when the SMU is turned on, the communication process takes place between the Arduino and GSM and it appears on the display screen that the connection has been established. After successfully establishing the connection, sensors begin to take readings from the soldier's body, and the GPS determines the geographical location of the soldier. This information will be presented to the soldier on the device's display. The soldier's data is sent periodically through GSM to the MSU every three minutes in the form of a short message service (SMS), and this message is encrypted by doubling the values in the SMU and is decoded by the MSU. A message can be sent urgently without waiting for the specified three minutes if the emergency button is used. Figure 3 shows the flow chart diagram of the SMU and Fig. 4 shows the flow chart diagram of the MSU.

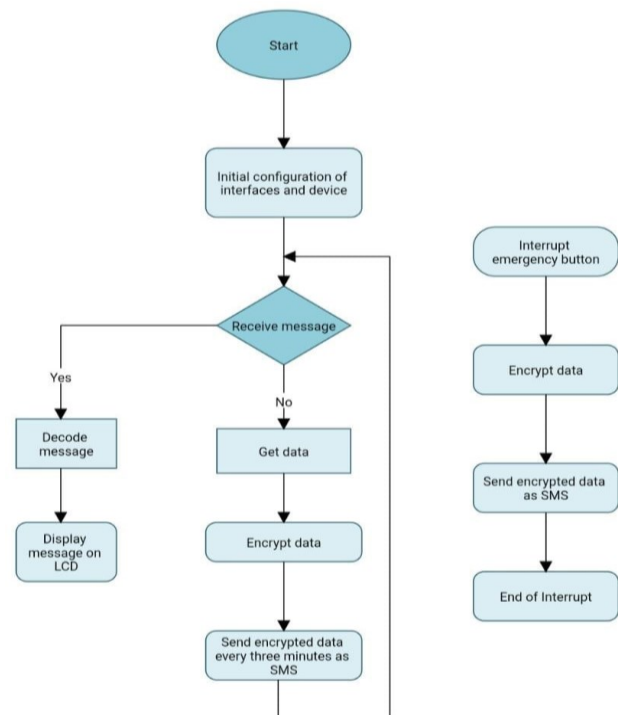

Fig. 3. Flow chart diagram of the soldier mobile unit

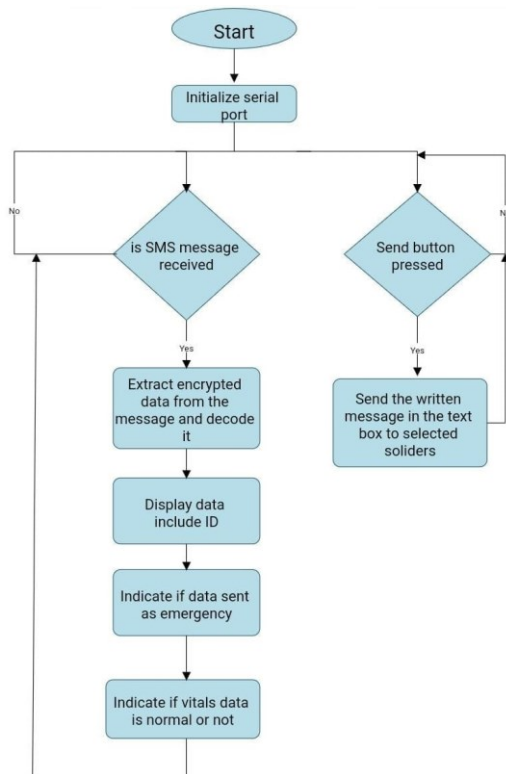

Fig. 4. Flow chart diagram of the monitoring station unit

VI. THE PROPOSED INTERACTIVE GRAPHICAL USER INTERFACE MODULE

In the MSU; at the army base the control room computer is connected to the GSM modem through an Arduino NANO circuit and runs the proposed interactive module's interface designed in LabVIEW language. All soldiers' data are displayed and stored in a database by the module using the soldiers' assigned ID. Figure 5 shows the IGUIM for the soldier health and position tracking system (SHAPTS). The main feature of the proposed IGUIM is that it's interactive, offers continuous monitoring of the soldiers' health and position and allows bidirectional communication between the soldiers and the army base in emergency situations.



Fig.5. The IGUIM for SHAPTS

The front panel of the IGUIM for SHAPTS consists of two main panels; a connection panel, and a control and monitoring panel.

A. The connection panel

This panel is divided into two parts as shown in Fig. 6:

- 1) *The connection between Arduino and LabVIEW consists of:*
 - Communication (Com) port: It is used to determine which com is connected to the Arduino.
 - Baud rate: It is used to determine the connection speed (9600 bps).
 - Available: Indicates that selected com is available to use and not busy.
- 2) *The connection between Arduino and GSM consists of three indicator LEDs.*
 - Check: Lights up green if GSM is connected to Arduino correctly.
 - Protocol data unit (PDU): This LED indicates that GSM is in text mode.
 - CNMI: This LED indicates that GSM will forward the message directly to the Arduino without storing it on GSM.

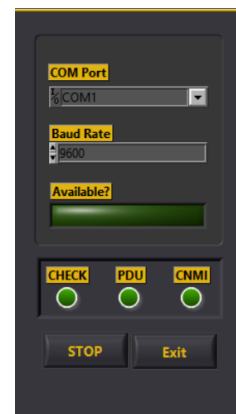

Fig. 6. The connection panel of the IGUIM for SHAPTS

B. The control and monitoring panel

This panel is divided into two parts as shown in Fig. 7:

1) *The soldier's data panel*

It includes a text box to display (ID number of the soldier, latitude, longitude, temperature and heart rate), three indication LEDs, and a check box used to select the soldier who needs help to send his location.

2) *The sending panel*

It includes the send button and the recipient list box to select the recipient soldiers. When the "Choose Recipient" button is pressed it will show four choices (the ID of the first, second, third and all soldiers, respectively as "SD1", "SD2", "SD3", "All"). When the send button is pressed the message will be sent to the selected recipient soldier that includes the location for the selected soldiers.

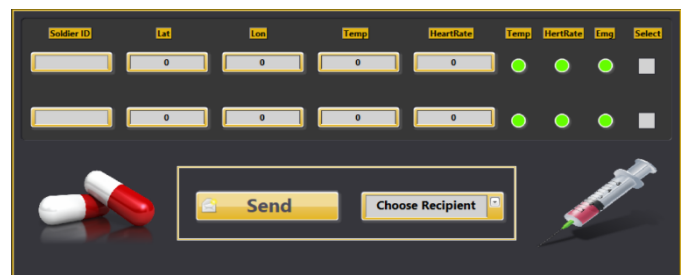

Fig. 7. The control and monitoring panel of the IGUIM for SHAPTS

VII. RESULTS AND DISCUSSION

Figure 8 demonstrates the SMU prototype after assembly.



Fig. 8. The assembled soldier mobile unit prototype

When the connection is made between the Arduino and the GSM, the Arduino begins to take readings from the GPS; longitude and latitude, as shown in Fig. 9, and vitals data from the bioinformatics as shown in Fig. 10, note that the shown readings on the LCD in Fig. 10 were taken before the temperature sensor calibration. These readings are displayed on the LCD and sent periodically to the MSU. The MSU displays the information on the IGUIM for SHAPTS.



Fig. 9. The soldier's geographical location



Fig. 10. The soldier's vital information

In the MSU, the Arduino NANO is connected to the computer, as shown in Fig. 11. The Arduino NANO operation is divided into two parts: Firstly, it receives the message via GSM and extracts the soldier's number and the content of the message, and then stores extracted data from the message. Secondly, it sends data from the soldiers to the computer which displays it on the application. In cases of an emergency, it will send a message that contains the ID numbers of the soldiers who need help and their locations to select recipients.

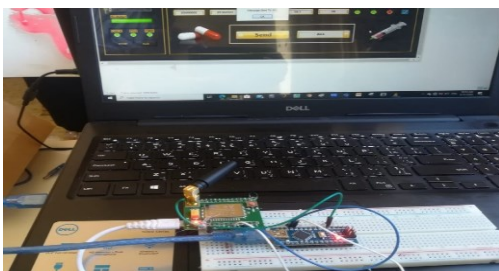

Fig. 11. The assembled monitoring station unit prototype

Figure 12 shows the IGUIM for SHAPTS when a soldier's information is sent periodically and there is no emergency.



Fig. 12. The IGUIM for SHAPTS when soldier information is sent periodically

If the vitals data of one of the soldiers are abnormal, a red colour will be displayed on the IGUIM for SHAPTS along with the information of the relevant soldier, as shown in Fig. 13, or in the case of an emergency button being pressed, as shown in Fig. 14; The control room personnel can select the soldiers who need help and select the recipient soldiers who are nearest in terms of geographical location.

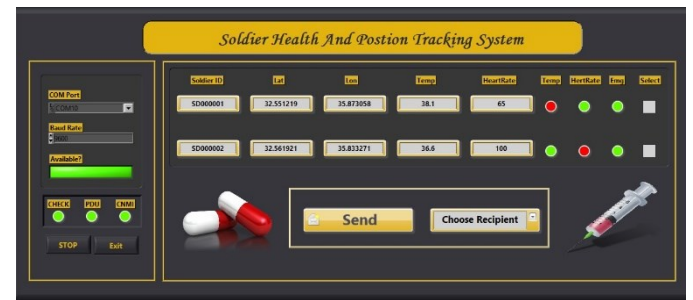

Fig. 13. The IGUIM for SHAPTS when there are abnormal soldier readings

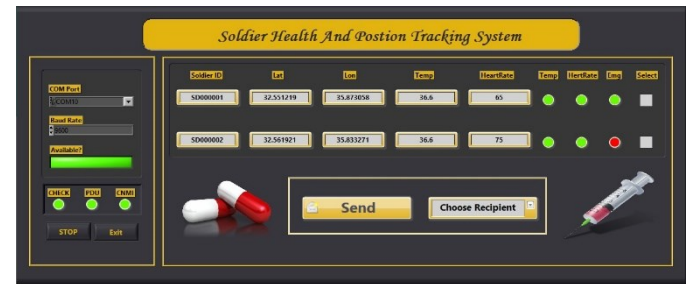

Fig. 14. The IGUIM for SHAPTS when a soldier presses the emergency button

A message will be sent to the soldier, who will provide aid, bearing the ID and location of the soldier who needs help as shown in Fig. 15 and 16, respectively. When the message successfully reaches the soldier, a message will appear on the application as shown in Fig. 17.



Fig. 15. Emergency soldier's ID



Fig. 16. Emergency soldier's location



Fig. 17. The IGUIM for SHAPTS when a message is sent to soldier SD1 correctly

VIII. CONCLUSION

The proposed IGUIM for soldier health and position tracking system is enabled by advancements in wireless and embedded technology. It can improve the soldiers' safety and improve the security of countries. The communication hurdles between soldiers and personnel at the army base were utilized by using GSM, the precise location and health parameters were gathered using GPS and bioinformatics, respectively. The bidirectional communication via GSM enables rapid response to critical and life-threatening situations.

The system components were assembled out with off-shelf resources. The system could be further improved with better capabilities. In future work, the soldier mobile unit can be integrated into a hand watch, with additional functionality like image capturing and voice commands.

REFERENCES

- [1] H. B. Lim, D. Ma, B. Wang, Z. Kalbarczyk, R. K. Iyer, and K. L. Watkin, "A soldier health monitoring system for military applications," *2010 International Conference on Body Sensor Networks, BSN 2010*, pp. 246–249, 2010, <https://doi.org/10.1109/BSN.2010.58>
- [2] C. V. K. B. C. B. M. M. D. P. S. M. Pranav Sailesh*, "Smart Soldier Assistance using WSN," in *International Conference on Embedded Systems - (ICES 2014)*, Jul. 2014, pp. 244–249.
- [3] S. Nikam, S. Patil, P. Powar, and V. S. Bendre, "GPS Based soldier tracking and health indication system," *International Journal of Advanced Research in Electrical, Electronics and Instrumentation Engineering*, vol. 2, 2013, [Online]. Available: www.ijareeie.com
- [4] M. R. Limbu and V. Kale, "GPS Based soldier tracking and health monitoring system," *International Journal For Technological Research In Engineering*, vol. 1, 2014, [Online]. Available: www.ijtre.com
- [5] C. C. Meerabi, G. Navya, K. Priyanka, and C. H. Sai Priya, "Soldier Health and Position Tracking System," *ICONIC RESEARCH AND ENGINEERING JOURNALS*, vol. 3, no. 10, pp. 116–120, Apr. 2020.
- [6] D. J. Ranjini, S. Raj, and Dr P. B. D., "Soldier Health and Position Tracking System using GPS and GSM Modem.," *International Journal of Engineering Research & Technology*, vol. 6, no. 13, Apr. 2018, [Online]. Available: www.ijert.org
- [7] S. L. Cotton, W. G. Scanlon, and B. K. Madahar, "Millimeter-wave soldier-to-soldier communications for covert battlefield operations," *IEEE Communications Magazine*, vol. 47, no. 10, pp. 72–81, 2009, <https://doi.org/10.1109/MCOM.2009.5273811>

- [8] J. Rantakokko *et al.*, "Accurate and reliable soldier and first responder indoor positioning: Multisensor systems and cooperative localization," *IEEE Wireless Communications*, vol. 18, no. 2, pp. 10–18, Apr. 2011, <https://doi.org/10.1109/MWC.2011.5751291>
- [9] V. Pereira, A. Giremus, and E. Grivel, "Modeling of Multipath Environment Using Copulas for Particle Filtering Based GPS Navigation," *IEEE Signal Processing Letters*, vol. 19, no. 6, pp. 360–363, 2012, [Online]. Available: <https://hal.archives-ouvertes.fr/hal-00772294>
- [10] G. R. V. P. V. A. B. S. V. M. V. N. R. Pavan Kumar, "Health Monitoring and Tracking of Soldier Using GPS," *International Journal of Research in Advent Technology*, vol. 2, no. 4, Apr. 2014.
- [11] E. Serag, M. M. A. Sayed, and M. Hanafy, "Smart Monitoring for Soldier Health and Location," <http://www.sciencepublishinggroup.com>, vol. 5, no. 6, p. 48, Jan. 2018, <https://doi.org/10.11648/J.AJESA.20170506.12>
- [12] A. Gondalia, D. Dixit, S. Parashar, V. Raghava, A. Sengupta, and V. R. Sarobin, "IoT-based Healthcare Monitoring System for War Soldiers using Machine Learning," *Procedia Computer Science*, vol. 133, pp. 1005–1013, Jan. 2018, <https://doi.org/10.1016/J.PROCS.2018.07.075>
- [13] "Arduino - Introduction." <https://www.arduino.cc/en/guide/introduction> (accessed Sep. 26, 2021).
- [14] "Arduino Boards Are Getting Cuter (and Cheaper) | Tom's Hardware." <https://www.tomshardware.com/news/arduino-nano-boards-specs-every-iot-ble-sense,39371.html> (accessed Sep. 26, 2021).
- [15] L. Louis, "WORKING PRINCIPLE OF ARDUINO AND USING IT AS A TOOL FOR STUDY AND RESEARCH," *International Journal of Control*, vol. 1, no. 2, 2016, <https://doi.org/10.5121/ijcaes.2016.1203>
- [16] "16x2 LCD Pinout Diagram | Interfacing 16x2 LCD with Arduino." <https://www.electronicsforu.com/technology-trends/learn-electronics/16x2-lcd-pinout-diagram> (accessed Sep. 26, 2021).
- [17] P. Srinivasan, A. Ayub Khan, T. Prabu, M. Manoj, M. Ranjan, and K. Karthik, "Heart beat sensor using fingertip through Arduino," *Journal of Critical Reviews*, vol. 7, no. 7, pp. 1058–1060, 2020, <https://doi.org/10.31838/JCR.07.07.192>
- [18] "What is a temperature sensor? | FierceElectronics." <https://www.fierceelectronics.com/sensors/what-a-temperature-sensor>
- [19] "Benefits of Programming Graphically in NI LabVIEW - NI." <https://www.ni.com/en-lb/innovations/white-papers/13/benefits-of-programming-graphically-in-ni-labview.html>
- [20] "Arduino Mega 2560 Rev3 — Arduino Official Store." <https://store.arduino.cc/products/arduino-mega-2560-rev3?queryID=undefined>
- [21] "Interface an LCD with an Arduino - Projects." <https://www.allaboutcircuits.com/projects/interface-an-lcd-with-an-arduino/> (accessed Sep. 26, 2021).
- [22] "In-Depth: Send & Receive SMS & Call with A6 GSM Module & Arduino." <https://lastminuteengineers.com/a6-gsm-gprs-module-arduino-tutorial/> (accessed Sep. 26, 2021).
- [23] "How to Interface Arduino Mega with NEO-6M GPS Module - Arduino Project Hub." <https://create.arduino.cc/projecthub/ruchir1674/how-to-interface-arduino-mega-with-neo-6m-gps-module-1b7283>
- [24] "MLX90614 Contactless IR Temperature Sensor Interfacing with Arduino." <https://microcontrollerslab.com/mlx90614-contactless-ir-temperature-sensor-pinout-interfacing-arduino/>
- [25] "Pulse Checking Sensor Using Arduino Mega 2560." <https://www.c-sharpcorner.com/UploadFile/7d4524/pulse-checking-sensor-using-arduinomega2560/>
- [26] "Arduino - Pushbutton." <https://www.arduino.cc/en/tutorial/pushbutton>
- [27] "LED Blinking with Arduino MEGA 2560 - Arduino Project Hub." <https://create.arduino.cc/projecthub/Mozahid/led-blinking-with-arduino-mega-2560-4dae35> (accessed Oct. 29, 2021).
- [28] "Arduino Nano — Arduino Official Store." <https://store.arduino.cc/products/arduino-nano>
- [29] "Instruction on how to connect your Arduino board to a computer and make it work | Open Source Photonics." <https://osphotonics.wordpress.com/2014/08/13/instruction-on-how-to-connect-your-arduino-board-to-a-computer-and-make-it-work/comment-page-1/>