

## DYNAMIC MODELLING OF BACTERIOPHAGE PRODUCTION PROCESS

Maciej Konopacki<sup>1,2\*</sup> , Bartłomiej Grygorcewicz<sup>1,2</sup> , Marta Gliźniewicz<sup>2</sup> ,  
Dominika Miłek<sup>2</sup> , Marian Kordas<sup>1</sup> , Rafał Rakoczy<sup>1</sup> 

<sup>1</sup>West Pomeranian University of Technology in Szczecin, Faculty of Chemical Technology and Engineering, Department of Chemical and Process Engineering, al. Piastów 42, 71-065 Szczecin, Poland

<sup>2</sup>Pomeranian Medical University in Szczecin, Chair of Microbiology, Immunology and Laboratory Medicine, Department of Laboratory Medicine, al. Powstańców Wielkopolskich 72, 70-111 Szczecin, Poland

Bacteriophages, viruses that can infect bacteria, are promising alternatives for antibiotic treatment caused by antibiotic-resistant bacteria strains. For that reason, the production of bacteriophages is extensively studied. Mathematical modelling can lead to the improvement of bioprocess by identification of critical process parameters and their impact on the demanded product. Dynamic modelling considers a system (i.e. bioreactor or bioprocess) as a dynamic object focusing on changes in the initial and final parameters (such as biomass concentration and product formation) in time, so-called signals and treats the studied system as a “black box” that processes signals. This work aimed to develop a mathematical model that describes bacteriophage production process. As result, we created a dynamic model that can estimate the number of bacteriophages released from cells as plaque-forming units at specific time points based on the changes in the bacteria host-cell concentration. Moreover, the proposed model allowed us to analyze the impact of the initial virus concentration given by multiplicity of infection (MOI) on the amount of produced bacteriophages.

**Keywords:** bacteriophages, mathematical modelling, dynamic modelling, bioprocess engineering, Simulink

### 1. INTRODUCTION

Bacterial infections cause a real problem in the global healthcare system. It is estimated that every year about 25,000 EU citizens die due to infection with antibiotic-resistant bacteria strains because the common treatment is very hard or nearly impossible (Ackermann, 2012). Microorganisms becoming highly resistant to antibiotics such as *Enterococcus faecium*, *Staphylococcus aureus*, *Klebsiella pneumoniae*, *Acinetobacter baumannii*, *Pseudomonas aeruginosa*, *Enterobacter spp.* were described as the “ESKAPE” group. Those bacteria cause high morbidity and mortality (Santajit and Indrawattana, 2016). A published report estimates that even 50 million people can die every year because of such infections if no worldwide protection action will be taken (O’Neill, 2014). In this reality, novel methods of bacterial infection treatment are being

\* Corresponding author, e-mail: [mkonopacki@zut.edu.pl](mailto:mkonopacki@zut.edu.pl)

<https://journals.pan.pl/cpe>

Presented at 3rd Seminar on Practical Aspects of Chemical Engineering PAIC 2022, 7–8 June 2022, Zaniemyśl, Poland.



sought. One of the promising alternatives is the bacteriophage treatment, which uses viruses infecting bacteria cells, due to its high specificity, ability to form a bacteria film (Basu et al., 2015; Drilling et al., 2014; Parasion et al., 2014), and potential safety in human treatment applications (Bruttin and Brüßow, 2005; Sarker et al., 2012).

Bacteriophages (or commonly phages) have more potential applications in the industry than in medicine. First of all, phages can be used in livestock breeding as an alternative to prohibited EU antibiotic growth stimulators. Moreover, in veterinary bacteriophages can be utilized as a preventive and therapeutic measure (Lim et al., 2012; Wang et al., 2006a; Wang et al., 2016b). Some reports show the potential of phage therapy applications in aquacultures (Crothers-Stomps et al., 2010; Kalatzis et al., 2016; Luo et al., 2015). Sanitation of post-production wastes originating from animal farms can be also cheaper by using bacteriophages with common chemical and thermal sanitation (Grygorcewicz et al., 2017; Heringa et al., 2010; Otawa et al., 2012). Additionally, phages can be employed in biosensors (Bhardwaj et al., 2017; Byeon et al., 2015; Hiremath et al., 2015), nanoparticle synthesis (Ahiwale et al., 2017; Brun et al., 2017; Chen et al., 2015), and battery electrodes (Winton, 2015). For that reason, improvement or novel methods of phage production are being sought.

Bacteriophages on the industrial scale are commonly produced in batch fermenters with small working volumes, but this method is characterized by limited efficiency (De Czekala et al., 1972; Sargeant, 1970; Sargeant et al., 1968; Siquet-Descans et al., 1973; Warner et al., 2014). One of the key parameters to obtain high phage titers and high volumetric throughput are the concentration of bacteria host-cell biomass, a moment of phage infection (phase of bacteria growth when viruses are introduced), and the initial concentration of phages given by the multiplicity of infection (MOI). MOI is the ratio of the number of phage particles to the bacteria host cells in a fermentor working volume. Proper control of those parameters can lead to a high improvement in bacteriophage production. Mathematical modelling is a very useful tool for selecting such process parameters. First of all, modelling can be used to better understand physical phenomena. For example, the dynamics of the contractile injection machinery of phage T4 was described with a nonlinear dynamic model (Maghsoodi et al., 2017). This model might be used to estimate the energy, time scales, and pathway of T4 injection process as well as the maximum amiable force for cell rupture. Moreover, the mathematical model can help in the evaluation of process development by predicting results that could be achieved. For example, previous studies have reported that the dynamic model of photosynthesis can give accurate predictions in photobioreactors (Brindley et al., 2016). It should be highlighted that no previous work has studied the application of the mathematical model to the bacteriophage production process.

This work aims to analyze the bacteriophage production process using the dynamic modelling approach. First of all, the bacteria growth curves (biomass vs. time) with the addition of phages will be described mathematically, resulting in a model input function. Then the mathematical description of the received amount of viruses in time, given by the plaque formation units, will be used as a model output function. Then the Laplace transform approach will be used to establish a transfer function and create a dynamic model. Finally, a proposed model will be used to the prediction of the initial MOI impact on the final concentration of the produced bacteriophages.

## 2. MATERIALS AND METHODS

### 2.1. Cell cultivation and bacteriophage growth

*Escherichia coli* ATCC® 11775™ (gram-negative) bacteria strain was employed as the phage host cells. For the determination of bacteriophage lysis, wild-type T4-like bacteriophage was used. The bacteria growth curves and bacteriophage lytic curves were prepared using an En-Vision®2105 multimode plate

reader (Perkin–Elmer), by measuring the optical density at 600 nm wavelength. Bacteria cultures of a given strain were cultivated overnight. Then cell suspension was diluted at 1:100 in a Luria–Bertani medium and incubated in shaken flasks (150 rpm) at 37 °C. Incubation was carried on until the high rate of bacteria cell multiplication occurred (the early logarithmic phase, optical density of about 0.1). In the current study, it was observed after about 60 min of the process. Following, bacteriophage suspension was added to the bacterial culture at different initial MOIs (0.01, 0.1, and 1). The optical density at 600 nm of each culture was monitored at 60 min intervals for at least 4 hours after phage addition, until the end of the lysis process. Each experiment was triplicated.

For selected processes, the amount of produced bacteriophages was evaluated every 1h with the use of the standard double layer method described elsewhere. Obtained data were presented as plaque-forming units (PFU/mL) (Augustyniak et al., 2018; Grygorcewicz et al., 2022; Konopacki et al., 2020; Roszak et al., 2022).

## 2.2. Dynamic modelling of bacteriophage production

Bacteria growth curve, as model input, was firstly described by a polynomial equation of fourth-order:

$$q(t) = a_1t^4 + b_1t^3 + c_1t^2 + d_1t + e_1 \quad (1)$$

where:  $a_1, b_1, c_1, d_1, e_1$  – parameters of Eq. (1).

The amount of produced bacteriophages was described by the following exponential function:

$$f(t) = p_1 \exp\left(\frac{t}{p_2}\right) + p_3 \quad (2)$$

where:  $p_1, p_2, p_3$  – parameters of Eq. (2).

To establish the transfer function both above formulas were transferred from the time to the  $s$  domain (the complex number domain) using the Laplace transform definition given by:

$$X(s) = \mathcal{L}[x(t)] = \int_0^{\infty} x(t)e^{-st} dt \quad (3)$$

where:  $x(t)$  – function in the time domain,  $X(s)$  – function in the complex domain.

Therefore, the input and output functions given by Eq. (1) and Eq. (2) in the complex domain will be defined as follows:

$$Q(s) = \frac{24a_1}{s^5} + \frac{6b_1}{s^4} + \frac{2c_1}{s^3} + \frac{d_1}{s^2} + \frac{e_1}{s} \quad (4)$$

$$F(s) = \frac{p_1}{s - \frac{1}{p_2}} + \frac{p_3}{s} \rightarrow \frac{(p_1 + p_3)s - \frac{p_3}{p_2}}{s^2 - \frac{s}{p_2}} \quad (5)$$

Transfer function  $H(s)$  is a ratio between model output  $F(s)$  and input  $Q(s)$ . Commonly, it is presented in the form of two simple polynomial equations. Combining Eq. (4) and Eq. (5) and simplifying the result, we will get the following form of transfer function:

$$H(s) = \frac{F(s)}{Q(s)} = \frac{Z_5s^5 + Z_4s^4 + Z_3s^3 + Z_2s^2 + Z_1s + Z_0}{P_7s^7 + P_6s^6} \quad (6)$$

where:  $Z_1-Z_5$  – numerator parameters,  $P_7, P_6$  – denominator parameters of Eq. (6).

It should be noted that the roots of the numerator of the transfer function are called zeros while the roots of the denominator of the transfer function are called poles of the transfer function. The transfer function is casual when the number of poles is equal to or greater than the number of zeros. This means that the output of the model and its internal states depend only on current and previous input values. As presented in Eq. (6) the order of denominator polynomial is higher than the order of numerator polynomial, so this requirement is fulfilled in the current study. In such a case, the transfer function is called strictly proper.

Transfer function  $H(s)$  allows for the prediction of the model response (in this case the amount of produced bacteriophages) by introducing various input (forcing) functions (in this case amount of bacteria host-cell biomass). Firstly, forcing function  $q(t)$  should be transferred from the time to the complex domain using Eq. (3) to receive function  $Q(s)$ . Then, based on the transfer function  $H(s)$  it is possible to predict the output function  $f(t)$  using the formula:

$$H(s) = \frac{F(s)}{Q(s)} \rightarrow F(s) = H(s)Q(s) \quad (7)$$

To switch back function  $F(s)$  to the time domain the inverse Laplace transform operation is required, which is defined as follows:

$$\mathcal{L}^{-1} [F(s)] \rightarrow f(t) = \frac{1}{2\pi i} \int_{R-i\omega}^{R+i\omega} F(s)e^{st} ds \quad \text{for } t > 0 \quad (8)$$

where:  $R$  – real value,  $i$  – imaginary number.

Combining Eq. (7) and Eq. (8) we will get the final form:

$$f(t) = \frac{1}{2\pi i} \int_{R-i\omega}^{R+i\omega} [H(s)Q(s)] e^{st} ds \quad \text{for } t > 0 \quad (9)$$

### 3. RESULTS AND DISCUSSION

The growth of *E. coli* cells was monitored using optical density (OD). A typical growth curve has the shape of a sigmoid, with clearly highlighted growth phases: lag, exponential and stationary. An addition of bacteriophages in the early part of the exponential phase changed this curve making it decay again. This is because of the virus infection on bacteria cells and the lysis process which finally freed new virus particles. A typical growth curve with and without the addition of bacteriophages is presented in Fig. 1.

In the current study, bacteriophages were added after 1 hour of the process. We can observe that the bacterial growth after the next 60 min is not changed (relating to control process without bacteriophages), but the next time point (3h) indicates clear bacterial growth inhibition due to virus activity. During the next few hours the amount of bacterial cells dropped at an approximately constant rate. From the second hour of the process, we were measuring the number of released bacteriophages in form of plaque-forming units (PFU). Typical changes of PFU during the process are shown in Fig. 2.

It could be noted that the amount of phages changed rapidly between 2 and 3 h and then changes were rather small, reaching the final concentration of about  $1.5 \cdot 10^{10}$  PFU/ml.

Experimental data presented in Figs. 1 and 2 were described by the mathematical functions given by Eq. (1) and Eq. (2), respectively. Using the Laplace transform (Eq. (3)) we were able to find out those function formulas in the complex domain  $s$ , which are given by Eq. (4) and Eq. (5). Finally, a transfer function

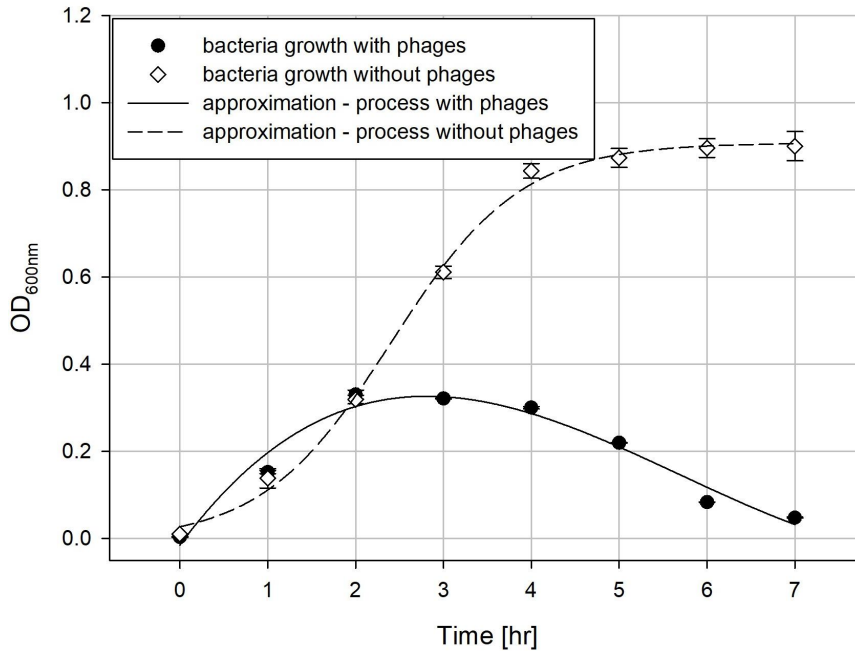

Fig. 1. The typical bacterial growth curve in the current study with and without the addition of bacteriophages

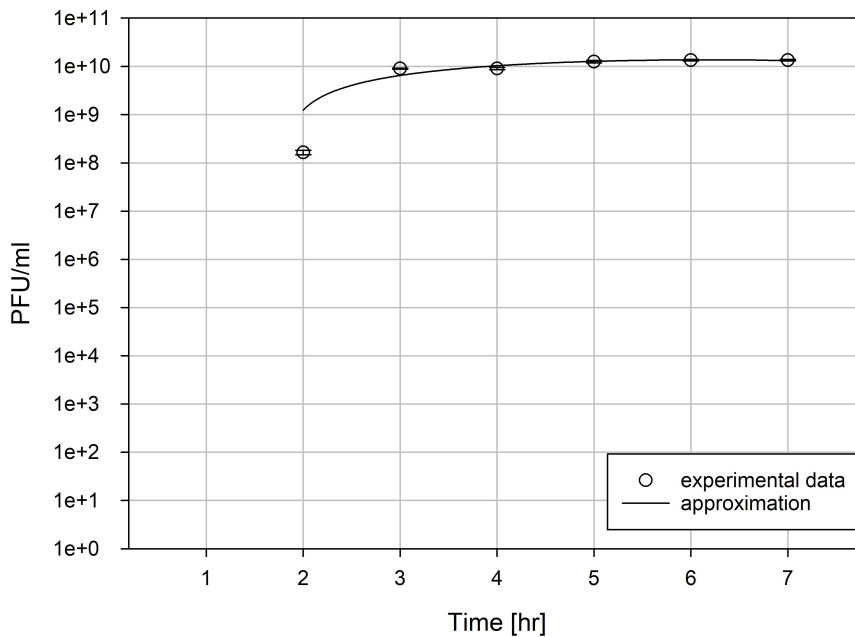

Fig. 2. Amount of released bacteriophages during the process

$H(s)$  was calculated as the ratio between the output and input function, as stated in Eq. (6). This transfer function gives us a dynamic model of bacteriophage multiplication that depends on the bacteria biomass changes given by the growth curve. The growth curve can be described by the more complex function, which could be treated as the model forcing function. It should be highlighted, that the adjustment of the forcing function to the real data has a big impact on the accuracy of the result. In the current studies we used the following formula of a double-logistic function:

$$q(t) = \frac{L}{1 + b_2 \exp(-kt) + c_2 \exp(ht)} \quad (10)$$

where:  $L, b_2, c_2, k, h$  – parameters of Eq. (10).

The adjustment of forcing function  $q(t)$  (given by Eq. (10) to the experimental data of bacterial growth with the addition of bacteriophages is depicted in Fig. 3.

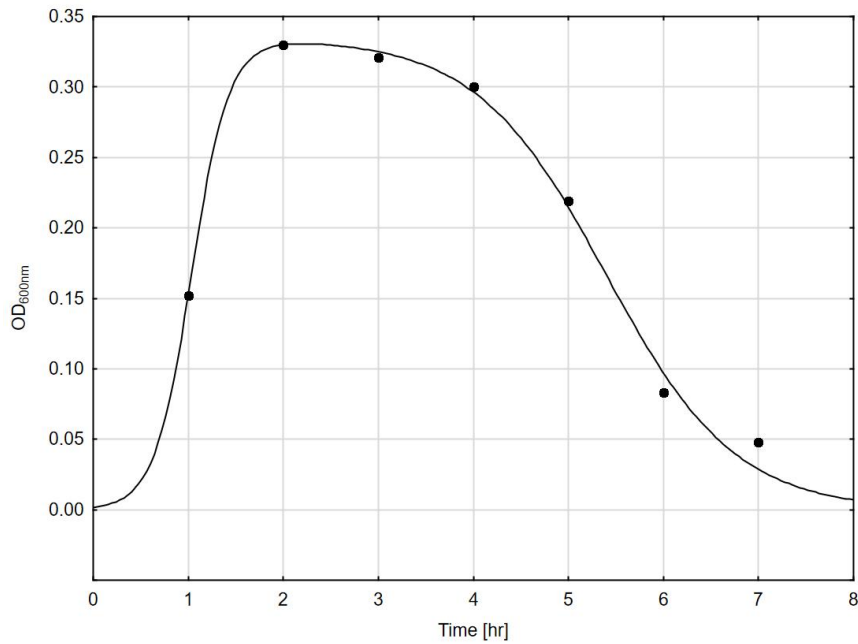

Fig. 3. Forcing function fitted to the experimental data of bacterial growth

Having both forcing and transfer functions allowed us to build a dynamic model. We created a block structure model using Matlab Simulink (MathWorks, USA). Each block of this model represents some mathematical operation, such as sum or multiplication. The created dynamic model structure is presented in Fig. 4.

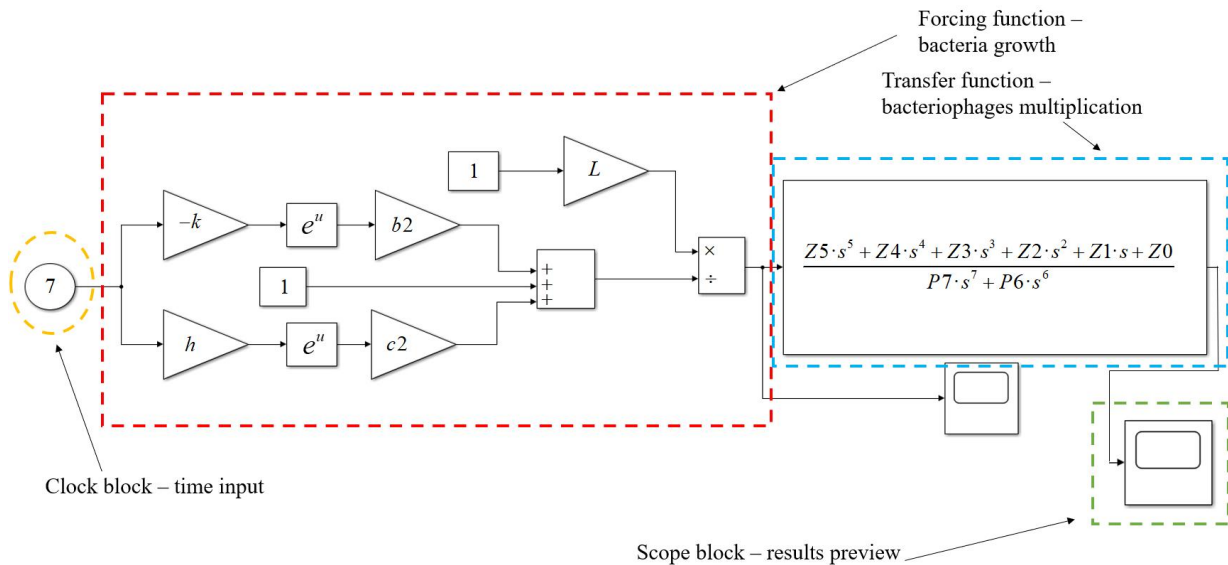

Fig. 4. Dynamic model structure created in Matlab and Simulink software representing Eq. (6) and Eq. (10)

The dynamic model presented in Fig. 4 treats mathematical formulas as continuous signal operations. As the initial signal a time input, simulating running time (up to 7 hours), was created which is connected to the forcing function simulating the bacteria growth with the addition of bacteriophages. Then the signal was introduced to the transfer function block which simulated the bacteriophage multiplication process. As a result, we received a continuous change of bacteriophage amount. We limited the result to start from the



second hour, to validate the dynamic model response, and compare it with the experimental data, which is presented in Fig. 5.

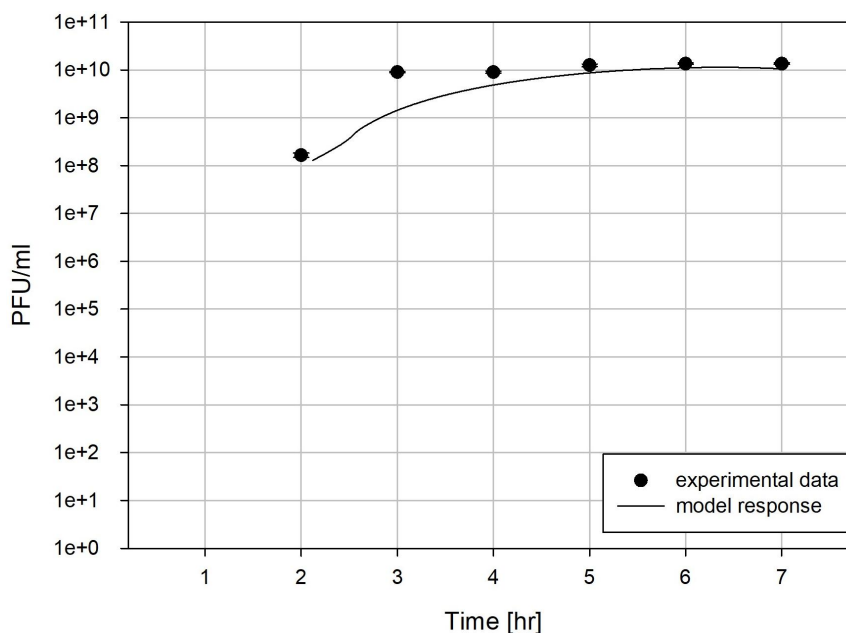

Fig. 5. Response of the created dynamic model

Obtained results indicate that the proposed dynamic model has good agreement with the experimental data. It allows to predict the final concentration of bacteriophages at the end of the process. The only difference with the experimental data is the slower adaptation of the model curve to the rapid changes, which could be seen at the third hour of the process. Nevertheless, the proposed dynamic model can estimate the produced amount of bacteriophages after a few hours of the process with high accuracy, based only on the bacterial growth curve behaviour. It gives a very important opportunity to predict the phage production process using only the optical density measurement of the bacteria host cells. Moreover, this allows for the optimization of the process parameters to find out the highest yield of bacteriophage concentrations.

To verify the model's usefulness, we decided to test the proposed dynamic model on a few various bacteriophage production processes. For this purpose, we used the growth curves for *E. coli* with the addition of phages we received previously (Konopacki et al., 2020). First of all, using the forcing function formula (Eq. (10)) we described the bacterial growth with the addition of phages and then we made an extrapolation to have 7 hour long input signal. These curves are presented in Fig. 6.

Obtained data show that the seven hours of the process is enough to almost totally reduce the produced amount of bacterial biomass. It should be noted that the data presented in Fig. 6 were received by introducing bacteriophages at the first hour of the process with various initial MOIs in the range from 0.01 to 1. For the presented data we did not measure the amount of produced phages previously. Therefore, we can use the model to make such prediction and verify which initial MOI can yield the highest amount of phages. For this purpose, we introduced to the dynamic model all three forcing functions received for the growth curves with various MOI. Results are illustrated in Fig. 7.

The obtained results show that the initial MOI value has a significant impact on the amount of bacterial biomass but also the produced bacteriophages. The highest concentration of phages was received for the lowest initial MOI. This could be connected with a relatively higher amount of remaining bacterial biomass at the process with lower MOI (see Fig. 6), thus more available host cells for virus multiplication. In other cases, bacteria may be killed too fast to reach a higher concentration of bacteriophages, which are dying when no more host cells are present. The delicate interaction between the virus concentration

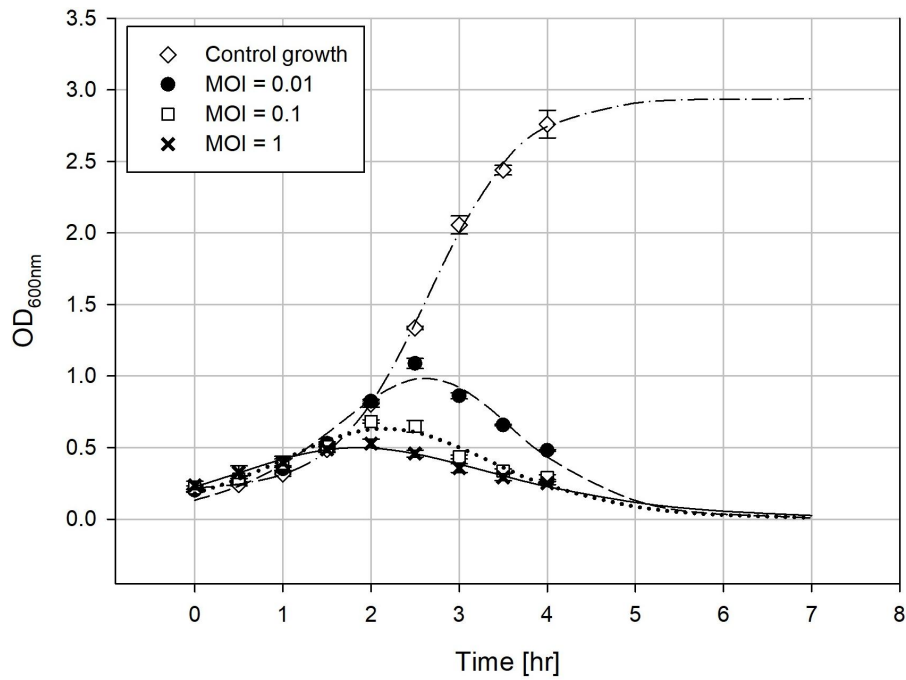

Fig. 6. Growth curves of *E. coli* with the addition of phages at various MOIs

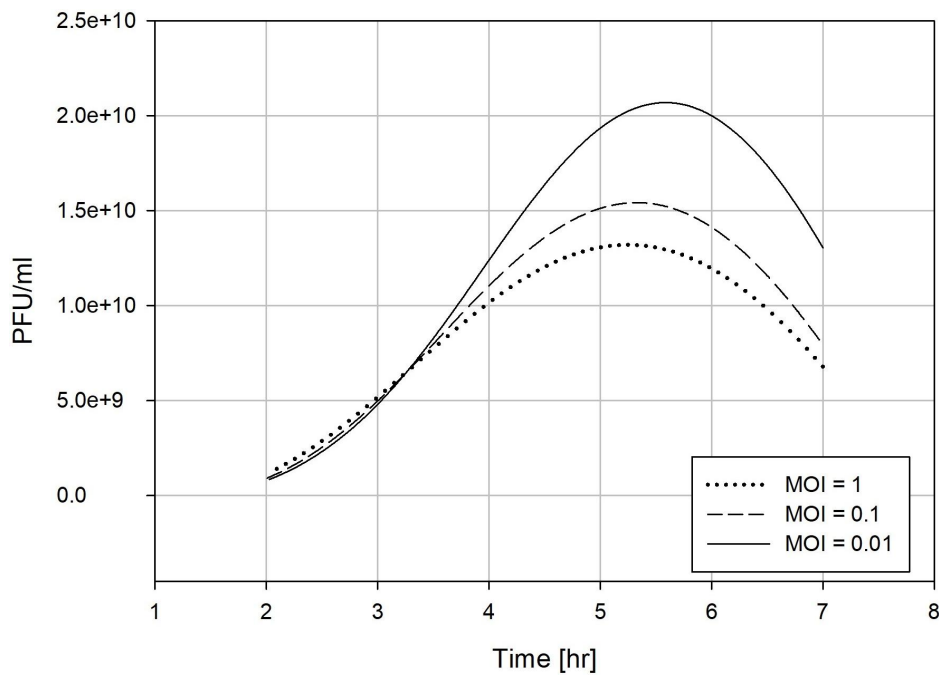

Fig. 7. Model response for various MOIs forcing functions (Eq. 10)

and the number of bacteria must be closely monitored, even the slightest fluctuations in it may affect the effectiveness of bacteriophage production (Ali et al., 2019; Mancuso et al., 2018; Siquet-Descans et al., 1973). Modeling results suggest that the highest amount of bacteriophages is possible to be achieved after 5–5.5 hours of the process for the studied conditions. After this time the amount of bacteriophages decreased. This is connected to the very low amount of remaining bacteria host cells in the last 6 and 7 hours which caused the death of phages.



#### 4. CONCLUSIONS

Bacteriophages could be a promising alternative for antibiotic treatment and provide many other valuable applications. However, the production methods are still in development and should be improved. In the current study, we proposed a novel dynamic model that describes bacteriophage production based on the bacterial host-cell growth curve. Measuring such growth is simple, so using the model can provide important information, such as the impact of various parameters like initial MOI, a moment of phage addition, and temperature at a low cost. We proposed a dynamic model created in Matlab Simulink that was validated against experimental data with good agreement. Moreover, we proved that this model can be used to predict bacteriophage production for various process parameters. In the current study, we tested the impact of initial MOI on the number of phages. Using the proposed dynamic model we found that the lowest MOI resulted in the highest final concentration of bacteriophages and we estimated the optimum time for given conditions to be around 5–5.5 hours to maximize bacteriophage production.

*This study was supported by the National Science Centre, Poland [OPUS 16, Project No. UMO-2018/31/B/ST8/03170, granted to Rafał Rakoczy].*

#### SYMBOLS

$a$	function parameter
$b$	function parameter
$c$	function parameter
$d$	function parameter
$e$	function parameter
$F(s)$	output signal in complex domain
$f(t)$	output signal in time domain
$h$	function parameter
$H(s)$	transfer function
$i$	imaginary number
$k$	function parameter
$L$	function parameter
$p$	function parameter
$P$	transfer function denominator parameter (pole parameter)
$Q(s)$	input signal in complex domain (forcing function)
$q(t)$	input signal in time domain (forcing function)
$R$	real part of complex number
$s$	complex (Laplace) domain
$t$	time (domain), h
$X(s)$	function in complex domain
$x(t)$	function in time domain
$Z$	transfer function numerator parameter (zero parameter)

#### *Mathematical operators*

$\mathcal{L}$	Laplace operator
---------------	------------------

#### *Subscripts*

1, 2	number of parameters
------	----------------------

## REFERENCES

- Ackermann H.-W., 2012. Who went into phage research? *Bacteriophage*, 2, 55–59. DOI: [10.4161/bact.18680](https://doi.org/10.4161/bact.18680).
- Ahiwale S.S., Bankar A.V., Tagunde S., Kapadnis B.P., 2017. A bacteriophage mediated gold nanoparticles synthesis and their anti-biofilm activity. *Indian J. Microbiol.*, 57, 188–194. DOI: [10.1007/s12088-017-0640-x](https://doi.org/10.1007/s12088-017-0640-x).
- Ali J., Rafiq Q., Ratcliffe, E., 2019. A scaled-down model for the translation of bacteriophage culture to manufacturing scale. *Biotechnol. Bioeng.*, 116, 972–984. DOI: [10.1002/bit.26911](https://doi.org/10.1002/bit.26911).
- Augustyniak A., Grygorcewicz B., Nawrotek P., 2018. Isolation of multidrug resistant coliforms and their bacteriophages from swine slurry. *Turk. J. Vet. Anim. Sci.*, 42, 319–325. DOI: [10.3906/vet-1710-102](https://doi.org/10.3906/vet-1710-102).
- Basu S., Agarwal M., Bhartiya S.K., Nath G., Kumar Shukla V., 2015. An in vivo wound model utilizing bacteriophage therapy of pseudomonas aeruginosa biofilms. *Ostomy Wound Manage.*, 61(4), 16–23.
- Bhardwaj N., Bhardwaj S.K., Mehta J., Kim K.-H., Deep A., 2017. MOF–Bacteriophage biosensor for highly sensitive and specific detection of *Staphylococcus aureus*. *ACS Appl. Mater. Interfaces*, 9, 33589–33598. DOI: [10.1021/acsami.7b07818](https://doi.org/10.1021/acsami.7b07818).
- Brindley C., Jiménez-Ruiz N., Ación F.G., Fernández-Sevilla J.M., 2016. Light regime optimization in photobioreactors using a dynamic photosynthesis model. *Algal Res.*, 16, 399–408. DOI: [10.1016/J.ALGAL.2016.03.033](https://doi.org/10.1016/J.ALGAL.2016.03.033).
- Brun C., Elchinger P.-H., Nonglaton G., Tidiane-Diagne C., Tiron R., Thuairé A., Gasparutto D., Baillin X., 2017. Metallic conductive nanowires elaborated by PVD metal deposition on suspended DNA bundles. *Small*, 13, 1700956. DOI: [10.1002/sml.201700956](https://doi.org/10.1002/sml.201700956).
- Bruttin A., Brüssow H., 2005. Human volunteers receiving *Escherichia coli* phage T4 orally: A safety test of phage therapy. *Antimicrob. Agents Chemother.*, 49, 2874–2878. DOI: [10.1128/AAC.49.7.2874-2878.2005](https://doi.org/10.1128/AAC.49.7.2874-2878.2005).
- Byeon H.M., Vodyanoy V.J., Oh J.-H., Kwon J.-H., Park M.-K., 2015. Lytic Phage-based magnetoelastic biosensors for on-site detection of methicillin-resistant *Staphylococcus aureus* on spinach leaves. *J. Electrochem. Soc.*, 162, 8, B230. DOI: [10.1149/2.0681508jes](https://doi.org/10.1149/2.0681508jes).
- Chen J., Duncan B., Wang Z., Wang L.-S., Rotello V.M., Nugen S.R., 2015. Bacteriophage-based nanoprobe for rapid bacteria separation. *Nanoscale*, 7, 16230–16236. DOI: [10.1039/c5nr03779d](https://doi.org/10.1039/c5nr03779d).
- Crothers-Stomps C., Høj L., Bourne D.G., Hall M.R., Owens L., 2010. Isolation of lytic bacteriophage against *Vibrio harveyi*. *J. Appl. Microbiol.*, 108, 1744–1750. DOI: [10.1111/j.1365-2672.2009.04578.x](https://doi.org/10.1111/j.1365-2672.2009.04578.x).
- De Czekala A., Luk D., Bartl P., 1972. Large-scale production of lambda bacteriophage and purified lambda deoxyribonucleic acid. *Appl. Microbiol.*, 23, 791–795. DOI: [10.1128/aem.23.4.791-795.1972](https://doi.org/10.1128/aem.23.4.791-795.1972).
- Drilling A., Morales S., Jardeleza C., Vreugde S., Speck P., Wormald P.-J., 2014. Bacteriophage reduces biofilm of *Staphylococcus aureus* ex vivo isolates from chronic rhinosinusitis patients. *Am. J. Rhinol. Allergy*, 28, 3–11. DOI: [10.2500/ajra.2014.28.4001](https://doi.org/10.2500/ajra.2014.28.4001).
- Grygorcewicz B., Roszak M., Rakoczy R., Augustyniak A., Konopacki M., Jabłońska J., Serwin N., Cecerska-Heryć E., Kordas M., Galant K., Dołęgowska B., 2022. PhageScore-based analysis of *Acinetobacter baumannii* infecting phages antibiotic interaction in liquid medium. *Arch. Microbiol.*, 204, 421. DOI: [10.1007/S00203-022-03020-7](https://doi.org/10.1007/S00203-022-03020-7).
- Grygorcewicz, B., Grudziński M., Wasak A., Augustyniak A., Pietruszka A., Nawrotek P., 2017. Bacteriophage-mediated reduction of *Salmonella Enteritidis* in swine slurry. *Appl. Soil Ecol.*, 119, 179–182. DOI: [10.1016/j.apsoil.2017.06.020](https://doi.org/10.1016/j.apsoil.2017.06.020).
- Heringa S.D., Kim J.K., Jiang X., Doyle M.P., Erickson M.C., 2010. Use of a mixture of bacteriophages for biological control of *Salmonella enterica* strains in compost. *Appl. Environ. Microbiol.*, 76, 5327–5332. DOI: [10.1128/AEM.00075-10](https://doi.org/10.1128/AEM.00075-10).
- Hiremath N., Guntupalli R., Vodyanoy V., Chin B.A., Park M.K., 2015. Detection of methicillin-resistant *Staphylococcus aureus* using novel lytic phage-based magnetoelastic biosensors. *Sens. Actuators, B*, 210, 129–136. DOI: [10.1016/J.SNB.2014.12.083](https://doi.org/10.1016/J.SNB.2014.12.083).
- Kalatzis P.G., Bastías R., Kokkari C., Katharios P., 2016. Isolation and characterization of two lytic bacteriophages,  $\phi$ St2 and  $\phi$ Grn1; phage therapy application for biological control of *Vibrio alginolyticus* in aquaculture live feeds. *PLoS One*, 11, e0151101. DOI: [10.1371/journal.pone.0151101](https://doi.org/10.1371/journal.pone.0151101).

- Konopacki M., Grygorcewicz B., Dołęgowska B., Kordas M., Rakoczy R., 2020. PhageScore: A simple method for comparative evaluation of bacteriophages lytic activity. *Biochem. Eng. J.*, 161, 107652. DOI: [10.1016/j.bej.2020.107652](https://doi.org/10.1016/j.bej.2020.107652).
- Lim T.H., Kim M.S., Lee D.H., Lee Y.N., Park J.K., Youn H.N., Lee, H.J., Yang, S.Y., Cho Y.W., Lee J.B., Park S.Y., Choi I.S., Song C.S., 2012. Use of bacteriophage for biological control of *Salmonella* Enteritidis infection in chicken. *Res. Vet. Sci.*, 93, 1173–1178. DOI: [10.1016/J.RVSC.2012.06.004](https://doi.org/10.1016/J.RVSC.2012.06.004).
- Luo Z.-H., Yu Y.-P., Jost G., Liu W.-H., Huang X.-L., Gu L., 2015. Characterization of two bacteriophages for specific treatment of biofilm formed by a *Vibrio* sp. isolated from an abalone farm. *Aquac. Res.*, 47, 3964–3972. DOI: [10.1111/are.12846](https://doi.org/10.1111/are.12846).
- Maghsoodi A., Chatterjee A., Andricioaei I., Perkins N.C., 2017. Dynamic model exposes the energetics and dynamics of the injection machinery for bacteriophage T4. *Biophys. J.*, 113, 195–205. DOI: [10.1016/J.BPJ.2017.05.029](https://doi.org/10.1016/J.BPJ.2017.05.029).
- Mancuso F., Shi J., Malik D.J., 2018. High throughput manufacturing of bacteriophages using continuous stirred tank bioreactors connected in series to ensure optimum host bacteria physiology for phage production. *Viruses*, 10, 537. DOI: [10.3390/v10100537](https://doi.org/10.3390/v10100537).
- O'Neill J., 2014. Antimicrobial resistance: Tackling a crisis for the health and wealth of nations. *Review on Antimicrobial Resistance*. London, United Kingdom. Available at: <https://amr-review.org/Publications.html>.
- Otawa K., Hirakata Y., Kaku M., Nakai Y., 2012. Bacteriophage control of vancomycin-resistant enterococci in cattle compost. *J. Appl. Microbiol.*, 113, 499–507. DOI: [10.1111/j.1365-2672.2012.05361.x](https://doi.org/10.1111/j.1365-2672.2012.05361.x).
- Parasion S., Kwiatek M., Gryko R., Mizak L., Malm A., 2014. Bacteriophages as an alternative strategy for fighting biofilm development. *Pol. J. Microbiol.*, 63, 137–145. DOI: [10.33073/pjm-2014-019](https://doi.org/10.33073/pjm-2014-019).
- Roszak M., Dołęgowska B., Cecerska-Heryć E., Serwin N., Jabłońska J., Grygorcewicz B., 2022. Bacteriophage-ciprofloxacin combination effectiveness depends on *Staphylococcus aureus* – *Candida albicans* dual-species communities' growth model. *Microb. Drug Resist.*, 28, 613–622. DOI: [10.1089/mdr.2021.0324](https://doi.org/10.1089/mdr.2021.0324).
- Santajit S., Indrawattana N., 2016. Mechanisms of antimicrobial resistance in ESKAPE pathogens. *Biomed Res. Int.*, 2016, 2475067. DOI: [10.1155/2016/2475067](https://doi.org/10.1155/2016/2475067).
- Sargeant K., 1970. Large-scale bacteriophage production. *Adv. Appl. Microbiol.*, 13, 121–137. DOI: [10.1016/S0065-2164\(08\)70402-7](https://doi.org/10.1016/S0065-2164(08)70402-7).
- Sargeant K., Yeo R.G., Lethbridge J.H., Shooter K.V., 1968. Production of bacteriophage T7. *Appl. Microbiol.*, 16, 1483–1488. DOI: [10.1128/aem.16.10.1483-1488.1968](https://doi.org/10.1128/aem.16.10.1483-1488.1968).
- Sarker S.A., McCallin S., Barretto C., Berger B., Pittet A.-C., Sultana S., Krause L., Huq S., Bibiloni R., Bruttin A., Reuteler G., Brüßow H., 2012. Oral T4-like phage cocktail application to healthy adult volunteers from Bangladesh. *Virology*, 434, 222–232. DOI: [10.1016/j.virol.2012.09.002](https://doi.org/10.1016/j.virol.2012.09.002).
- Siquet-Descans F., Calberg-Bacq C.M., Delcambe L., 1973. Large scale production of bacteriophage  $\Phi \times 174$ . *Biotechnol. Bioeng.*, 15, 927–932. DOI: [10.1002/bit.260150510](https://doi.org/10.1002/bit.260150510).
- Wang J., Hu B., Xu M., Yan Q., Liu S., Zhu X., Sun Z., Reed E., Ding L., Gong J., Li Q.Q., Hu J., 2006a. Use of bacteriophage in the treatment of experimental animal bacteremia from imipenem-resistant *Pseudomonas aeruginosa*. *Int. J. Mol. Med.*, 17, 309–317. DOI: [10.3892/ijmm.17.2.309](https://doi.org/10.3892/ijmm.17.2.309).
- Wang S., Zeng X., Yang Q., Qiao S., 2016b. Antimicrobial peptides as potential alternatives to antibiotics in food animal industry. *Int. J. Mol. Sci.*, 17, 603. DOI: [10.3390/ijms17050603](https://doi.org/10.3390/ijms17050603).
- Warner C.M., Barker N., Lee S.W., Perkins E.J., 2014. M13 bacteriophage production for large-scale applications. *Bioprocess Biosyst. Eng.*, 37, 2067–2072. DOI: [10.1007/s00449-014-1184-7](https://doi.org/10.1007/s00449-014-1184-7).
- Winton A., 2015. Polypeptides for bio-tethering and self-assembly of lithium ion battery electrodes. *Biophys. J.*, 108, 630a. DOI: [10.1016/j.bpj.2014.11.3422](https://doi.org/10.1016/j.bpj.2014.11.3422).

Received 11 July 2021

Received in revised form 26 August 2022

Accepted 16 September 2022

APPENDIX

Table A1. Parameters of bacterial growth curves

Figure	Curve	Parameters				
		$L$	$b_2$	$k$	$c_2$	$h$
Fig. 3		0.3345	201.42	5.12365	3.53E-04	1.47384
Fig. 6	MOI = 1	1.056	3.528883	1.089216	0.144768	0.802686
	MOI = 0.1	1.36	6.530341	1.123615	0.048561	1.141313
	MOI = 0.01	2.172	15.34346	1.207997	0.013956	1.406864
		$a$	$b$	$x_0$	$y_0$	
Fig. 6	Control	2.7381	0.5229	2.6566	0.2007	