



Research paper

Investigation of thermal and air efficiency in trombe wall of modular building

Vasyl Zhelykh¹, Malgorzata Ulewicz², Yurii Furdas³,
Volodymyr Shepitchak⁴

Abstract: The proposed Trombe wall design is an innovative and effective solution for addressing issues related to building energy efficiency. The Trombe wall can help reduce a building's energy consumption, provide optimal indoor temperature, and minimize the building's environmental impact by utilizing renewable energy sources. The article deals with the study of the heat-air characteristics of the Trombe Wall, which performs the functions of external protection of a modular house, with the aim of further evaluating the possibility of using it as a hybrid protection with additional heating and ventilation functions assigned to it. The results of experimental research conducted on one of the elements of external protection of a modular house in the form of the Trombe Wall are presented. The experimentally obtained graphic dependences were compared with the calculated data and the convergence was evaluated. The proposed design allows you to organize air exchange in the premises with a multiplicity within $1-1.5 \text{ h}^{-1}$, and also provides an opportunity to provide additional thermal power in the amount of 250 W/m^2 . The article presents the results of experimental studies that allow to evaluate the thermal characteristics of the proposed design of external protection for a modular house. These results indicate that with the given geometric dimensions, in particular with a volume of 14 m^3 , the thermal power utilized by the Trombe wall is within $0.2-0.7 \text{ kW}$.

Keywords: modular house, thermal characteristics, thermosiphon solar collector, Trombe Wall

¹Prof., DSc., Eng., Czestochowa University of Technology, Faculty of Civil Engineering, Dabrowskiego 69, 42-201 Czestochowa, Poland, e-mail: vasyl.zhelykh@pcz.pl, ORCID: 0000-0002-5063-5077

²Assoc. Prof. DSc. Czestochowa University of Technology, Faculty of Civil Engineering, Dabrowskiego 69, 42-201 Czestochowa, Poland, e-mail: malgorzata.ulewicz@pcz.pl, ORCID: 0000-0001-8766-8393

³PhD., Eng., Lviv Polytechnic National University, Department of Heat and Gas Supply and Ventilation 79013 Lviv, Ukraine, e-mail: yurii.v.furdas@lpnu.ua, ORCID: 0000-0002-0572-6236

⁴PhD., Eng., Lviv Polytechnic National University, Department of Heat Engineering and Thermal and Nuclear Power Plants, 79013 Lviv, Ukraine, e-mail: volodymyr.b.shepitchak@lpnu.ua, ORCID: 0000-0001-5883-548X

1. Introduction

In the conditions of the growing shortage of organic fuels, the trend of increasing electricity prices, methods of obtaining alternative renewable energy sources are becoming more and more relevant. And their application to maintain the thermal conditions of buildings. Alternative energy sources and innovative systems of their use make it possible to ensure stability in the operation of energy-saving buildings. Of course, an important aspect of the building's energy efficiency remains its architectural features, in particular the size and orientation of the building block, as well as the efficiency of the operation of internal engineering networks. A smart combination of external protection and receivers of solar energy and converters of it into thermal energy allow to ensure the functioning of heating systems and hot water supply systems [1–7].

At present, there is still a large enough share of the housing stock and industrial facilities built according to the old standards, which require immediate reconstruction, bringing the thermal stability of buildings to the existing requirements and replacing heat supply systems, re-equipping these systems for the possibility of using alternative energy sources [8, 9], including passive systems [10, 11]. Systems using solar energy with the use of solar collectors remain quite effective. There are a number of works devoted to a thorough scientific examination of the methods that give the greatest effect of converting solar energy into thermal energy. Research was carried out by modeling thermal processes in systems with solar collectors [12–15], as well as through wide-parameter experimental studies [10, 17–20]. Modern designs of solar collectors make it possible to choose the type of solar collector and its technical characteristics necessary for heat supply systems should be made on the basis of comparison and in-depth analysis [21–24]. At the same time, the effective operation of such systems, especially in buildings of a high energy efficiency class, is possible thanks to control and regulation systems [25, 26].

Recently, hybrid systems using solar energy have gained particular popularity, in particular, those implemented in building structures or external protection [27–32]. This makes it possible to use solar collectors not only for preparing hot water, but also for ventilation and heating of the premises of the building. Separate attention should be paid to air solar collectors [33–36]. These include systems with passive use of solar energy, namely the Trombe Wall [37, 38]. Although the operation of such devices is affected by external factors, such as wind pressure [39], the intensity of solar radiation, they still remain quite effective from the point of view of energy saving, since they do not require additional mechanisms for transporting the coolant. This is confirmed by a number of scientific works devoted to the modeling of thermal processes in the Trombe Wall [40–44], as well as the results of experimental studies that testify to the effectiveness of such structures throughout the year [45–48]. Currently, the use of such technologies in modular construction remains quite relevant, especially when there is a need to accommodate temporarily displaced people from regions of military operations or natural disasters. The purpose of the study is to establish the peculiarities of the work of the Trombe Wall implemented in the external protection of a modular house. To evaluate the possibility of this structure working as a passive heating and ventilation device, which would make it possible to organize air exchange

in the room and provide its partial heating, and accordingly reduce the load on the main heating and ventilation equipment [49]. The Trombe wall is easy to install, it does not require additional management and can significantly save energy. These designs are often explored in the warm season as well, assessing the possibility of enhancing natural ventilation and providing additional energy savings [50]. So, the Trombe Wall is a thermal solar collector that has several advantages compared to conventional walls: (1) high efficiency: the Trombe Wall can collect intense solar radiation and use it to raise the temperature of the air immediately behind it; this allows you to reduce heating costs and increase the efficiency of the system, (2) durability: the Trombe Wall has a long service life and requires minimal maintenance, and (3) low costs: production and installation of the Trombe Wall can be cheaper compared to conventional heating systems.

2. Study of the thermal characteristics of the Trombe Wall

The average surface temperature in the layer of the air channel is equal:

$$(2.1) \quad \bar{t} = \frac{t_{w1} + t_{w2}}{2} = \frac{70 + 20}{2} = 45^{\circ}\text{C}$$

where t_{w1} – initial temperature on the surface of the channel wall; t_{w2} – final temperature on the surface of the channel wall.

Volumetric expansion of air at $\bar{t} = 45^{\circ}\text{C}$ is determined from the dependence:

$$(2.2) \quad \beta = \frac{1}{\bar{T}}$$

where \bar{T} – absolute average collector temperature, $\beta = 1/(273 + 45) = 3.145 \times 10^{-3}$, K^{-1}

Grashof's number is defined:

$$(2.3) \quad \text{Gr} = g \times \left(\frac{(l_{\text{det}})^3}{\nu^2} \right) \times \beta \times (t_{w1} - t_{w2}) = 4.87 \times 10^8$$

where g – free fall acceleration, $g = 9.81 \text{ m/s}^2$; ν – kinematic viscosity, $\nu = 17.8 \times 10^{-6}$, m^2/s ; l_{det} – defining size, m. This value was taken as the height of the air layer of the Trombe

Wall, scilicet $l_{\text{det}} = h$. Since the results of the analytical evaluation of the thermal and air characteristics of the Trombe Wall were later compared with the data obtained at the experimental installation, the adopted geometric dimensions corresponded to the geometric dimensions of the experimental sample, respectively: $h = 3 \text{ m}$.

Thus, the number $\text{Gr} \times \text{Pr} = 9.36 \times 10^{10} \gg 2 \times 10^7$. For this case, a turbulent flow regime is observed in the boundary layer during natural convection, and accordingly the Nusselt number is determined:

$$(2.4) \quad \overline{\text{Nu}} = c \times (\text{Gr} \times \text{Pr})^n = 0.135 \times (\text{Gr} \times \text{Pr})^{0.33} = 563.5$$

Average heat transfer is:

$$(2.5) \quad \bar{\alpha}_k = \overline{Nu} \times \left(\frac{\lambda}{h} \right) = 5.25$$

where $\lambda = 0.028 \text{ W}/(\text{m}\cdot\text{K})$ – thermal conductivity.

The thermal power of the Trombe Wall Q_k , w can be determined from the dependence and it will be equal:

$$(2.6) \quad Q_k = \bar{\alpha}_k \times F \times (t_{w1} - t_{w2})$$

where F – the area of the heated surface of the thermosiphon solar collector, was defined as:

$$(2.7) \quad F = h \times b$$

where b – the width of the heated surface of the Trombe Wall air channel, m.

This value was taken from the condition of the geometric dimensions of the experimental module and was equal $b = 0.5 \text{ m}$, in accordance $F = 1.5 \text{ m}^2$.

Therefore, the amount of heat that corresponded to the thermal power of the Trombe Wall in the corresponding geometric dimensions of the experimental module was equal to approximately 400 W.

The heat-air balance of the structure was recorded in the form of a system of equations:

$$(2.8) \quad \begin{cases} Q_k = \bar{\alpha}_k \times F \times (t_{w1} - t_{w2}) \\ Q_k = G \times c_p \times (t_{w1} - t_{w2}) \end{cases}$$

where c_p – specific heat capacity of air, $c_p = 1000, \text{ J}/(\text{kg}\cdot\text{K})$; G – the mass flow of air that passes through the air gap of the Trombe Wall, kg/s.

$$(2.9) \quad G = L \times \bar{\rho}$$

in this addition L – volume flow of air, m^3/s ; $\bar{\rho}$ – average air density, kg/m^3 :

$$(2.10) \quad \bar{\rho} = \frac{353}{273 + \bar{t}}$$

From the system of equations (2.8), a dependence was obtained for determining the volume flow of air in the air layer:

$$(2.11) \quad \begin{aligned} \bar{\alpha}_k \times F \times (t_{w1} - t_{w2}) &= L \times \bar{\rho} \times c_p \times (t_{w1} - t_{w2}) \rightarrow \\ \rightarrow L &= \frac{\bar{\alpha}_k \times h \times b}{\bar{\rho} \times c_p} \end{aligned}$$

3. Methodology

Setting the task for conducting research: analytical determination of the heat-air balance for the Trombe Wall in the conditions of operation of a modular house. Construction of graphical dependences of air flow on the width of the construction module and its height,

experimental determination of the regularity of the thermal power of the Trombe Wall at different thicknesses of the air layer. Comparison of graphical dependencies obtained analytically with the results of the experiment, which behaved on an experimental installation made from a part of the external protection with the Trombe Wall implemented in it, when the wall surface was irradiated with a heat flow of different intensity, which corresponded to solar radiation.

Scientific novelty of the work: The proposed design of the hybrid external protection of the modular house with the Trombe Wall implemented in it. The thermal characteristics of the proposed design of external protection for a modular house were experimentally investigated.

At the first stage, an analytical assessment of the heat-air characteristics of the structure of the external protection of the modular house with the Trombe Wall implemented in it was carried out. At the same time, special attention was paid to the fact that when the external protection is exposed to the sun, its surface is heated. The temperature of the outer surface reaches 70°C , while the indoor air temperature of the modular house is 20°C . Thus, the phenomenon of free convection occurs in the Trombe Wall, the physical model of which is shown in Fig. 1. This figure shows the height of the Trombe Wall – h ; the thickness of the air layer is marked – δ ; the initial temperature on the surface of the channel wall is shown – t_{w1} ; the final temperature on the surface of the channel wall is marked – t_{w2} ; the initial air temperature is indicated t_{air1} and the final air temperature is indicated t_{air2} .

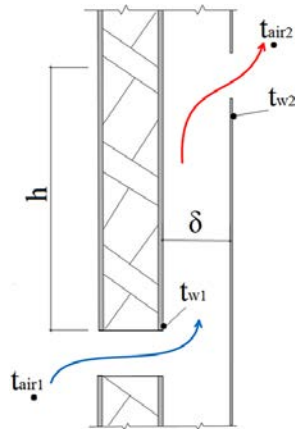

Fig. 1. A simplified model of hot air flows in the Trombe Wall

For the analysis, it was assumed that the temperature of the surfaces of the air channel of the Trombe Wall $t_{w1} = 70^{\circ}\text{C}$ and $t_{w2} = 20^{\circ}\text{C}$ were assumed to be approximately equal to air temperatures t_{air1} and t_{air2} .

Thermophysical properties of air at $\bar{t} = 45^{\circ}\text{C}$:

- thermal conductivity $\lambda = 0.028 \text{ W}/(\text{m}\cdot\text{K})$;
- kinematic viscosity $\nu = 17.8 \times 10^{-6} \text{ m}^2/\text{s}$;
- Prandtl number $\text{Pr} = 0.712$.

By substituting the output data into formula (2.11), in particular, the accepted temperatures of the air environment and the geometric parameters of the external protection of the experimental module with the Trombe Wall implemented in it, a graphical dependence (Fig. 2) of the volumetric air flow was obtained (L , m^3/h), which passes through the air gap depending on the geometric parameters such as the width of the module (b , m) and its height (h , m).

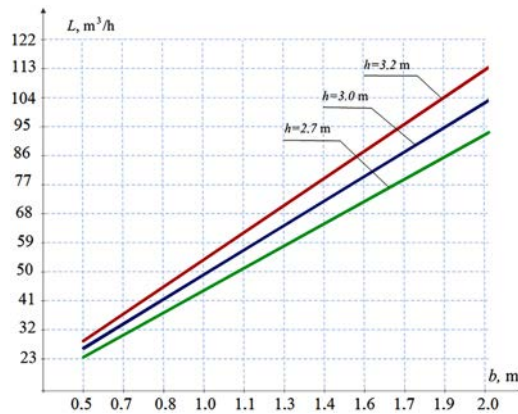

Fig. 2. Dependence of volumetric air flow L , m^3/h in the Trombe Wall

The resulting graphical dependence makes it possible to draw a conclusion that, under the considered conditions, this design allows organizing air flow at costs that meet the requirements for calculated air exchange in residential premises. So, in particular, with a height of external protection of 3 m and a width of the Trombe Wall module of 2 m, the air jet will be equal to more than $100 \text{ m}^3/\text{h}$, so for residential premises of medium size by volume, the air exchange rate will be within the limits $1\text{--}1.5 \text{ h}^{-1}$. In addition, the amount of heat that can be utilized by the Trombe Wall under the considered conditions is approx $250 \text{ W}/\text{m}^2$. At the same time, the ratio of the area of the module F_m to the area of the Trombe wall F_t was ensured, which was $F_m/F_t = 3.6$; and the ratio of the volume of the module V_m to the volume of the Trombe wall layer V_t was in the range of V_m/V_t from 93 to 233.

The second stage was the experimental research, which was carried out in laboratory conditions. It was the determination of the thermal power of the Trombe Wall with a variable thickness of the air layer and the area of the ventilation holes. Experimental studies were conducted with the aim of analyzing the processes of formation of parameters of the thermal regime of the Trombe Wall; determination of the necessary values of the influence factors, in particular the temperature of the environment, air mobility and the intensity of solar radiation.

According to the analysis of the processes of forming the thermal regime, the following experimental research tasks were set: to establish the regularities of the thermal power of the Trombe Wall implemented in the external protection of the module at different thicknesses of the air layer. An experimental study to determine the thermal capacity of the Trombe Wall was carried out based on the planning of the experiment, to consider such factors as

the thickness of the air layer and the area of the inlet and outlet openings. A fragment of the premises of a modular house with a hybrid exterior, in which the Trombe Wall is installed, is presented in Fig. 3.

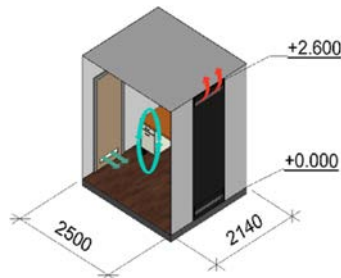

Fig. 3. Premises of a modular house with an integrated Trombe Wall

The Trombe wall uses solar energy to heat and ventilate the premises. This design is used to provide natural ventilation, which ensures air exchange in the room. Proper use of this design can become an effective alternative to traditional ventilation systems. In the ventilation mode, this design works as follows: the sun shines on the surface of the wall, which in turn heats the air that is between the absorbing surface 3 and the inner wall 5. This heated air becomes lighter and rises up, creating draft. This draft is used to ventilate the room by drawing in fresh air from the outside and releasing used air to the outside.

To regulate the flow of air passing through the Trombe wall for ventilation, regulating grids 4 are installed, which provide air supply and removal. It is also important to ensure tightness to preserve heat. Therefore, the possibility of using the Trombe wall for ventilation consists in providing natural ventilation with the help of solar energy.

4. The experimental installation

For conducting research, an experimental installation was developed, which was made in life size from the same structural materials as the external protection of the modular house (Fig. 4b).

4.1. The principle of operation of the installation

Infrared rays heat up the metal plate 3, due to the temperature difference, a “thermosiphon effect” occurs (the phenomenon of free convection), i.e. cold air from the room enters the Trombe Wall through the lower opening, heats up and rises up due to the difference in densities, and returns heated to the room through upper outlet. The speed and volume of air passing through the Trombe Wall housing is equalized by adjusting the distance of the steel plate and dampers.

The proposed system uses thermal stratification of the air and natural convection to provide thermal energy of the internal environment [51]. The Trombe wall changes the

internal average radiation temperature, and in combination with the speed of the air coming out of the ventilation holes, can lead to a deterioration of the thermal comfort conditions in the room. Therefore, it is necessary to control the opening and closing of these openings in order to obtain the greatest thermal effect and not disturb the temperature comfort [52]. The scheme of the experimental setup is shown in Fig. 4, and design of a Trombe Wall in Fig. 5.

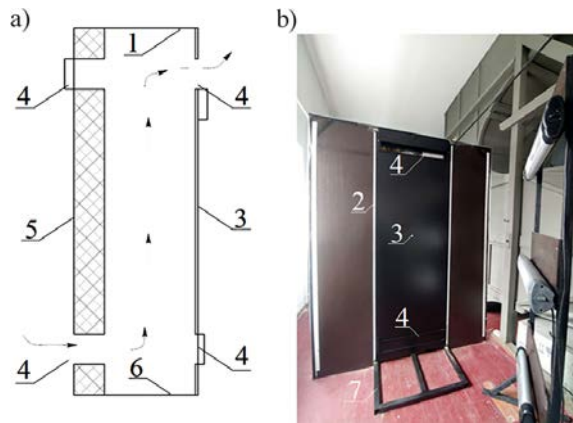

Fig. 4. Scheme of the experimental setup

Figures 4 and 5 show a circuit of a Trombe Wall. In these figures is reflected the upper profile 1 to which it is attached the duty profile (2 pcs.) 2. Facial panel is marked with the number 3, for adjusting the area of the inlet and outlet holes is provided regulating valves 4. Sandwich panel 5 is intended to reduce heat loss. For the stability of the design is provided lower profile 6 and frame 7.

Experimental studies were carried out in a hermetic module with an area $F_m = 5.4 \text{ m}^2$ and volume $V_m = 14 \text{ m}^3$, that imitated a living space.

Thermophysical characteristics of the Trombe wall:

1. The proposed design is completely non-transparent.
2. The heat transfer resistance of the Trombe wall structure is $9.25 \text{ (m}^2 \cdot \text{K)/W}$.
3. The absorption capacity of the absorption plate is 0.91.
4. Heat loss through the Trombe wall is 5 W/m^2 .

The order of research was as follows:

1. First, the infrared (IR) heaters were turned on, and the temperature of the metal plate was measured with a pyrometer.
2. Using a thermal anemometer, every 10 min for 8 h, the temperature and speed of air from the outlet, inlet and in the middle of the installation were measured.
3. The intensity of IR radiation was measured with an albedometer.
4. Depending on the inter-plate distance $\delta \text{ m}$ and radiation intensity $I = \text{const, W/m}^2$ the experiments were repeated.
5. Research results were processed.

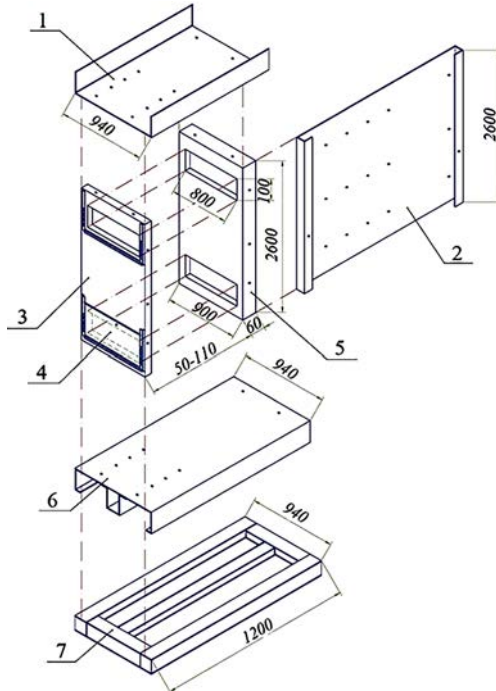

Fig. 5. Design of a Trombe Wall

4.2. Analysis of measurement errors

Determining the error of experimental measurements is an important component of the process of scientific research. The main purpose of error determination is to assess the accuracy of measurement results and ensure their reliability. The measurement error can be caused by various factors, one of which can be the inaccuracy of the device. Determining the error allows, if necessary, to correct the measurement results and ensure their compliance with the required accuracy.

Determination of measurement errors was carried out by calculating the errors of parallel experiments [53].

The arithmetic mean of each of the three parallel randomized experiments is equal to the sum of all n separate results divided by n .

$$(4.1) \quad \bar{y} = \frac{1}{n} \sum_{i=1}^n y_i$$

where y_i – measured values; n – the number of measurements, i – the serial number.

The deviation for all \bar{y} can be represented as the difference $\Delta y = y_i - \bar{y}$. The presence of Δy indicates a variation in the values of repeated experiments. The variance (s_2) is used

to measure this variation.

$$(4.2) \quad s^2 = \frac{1}{n-1} \sum_1^n \Delta y_i^2$$

$$(4.3) \quad s^2 = \frac{1}{n-1} \Delta y_i^2$$

where $n - 1$ is the number of degrees of freedom, which is 1 less than the number of experiments.

The average squared deviation of the value $\sum_{i=1}^n y_i$ from the average value \bar{y} was calculated according to the formula:

$$(4.4) \quad s = \sqrt{s^2} = \sqrt{\frac{1}{n-1} \sum_1^n (y_i - \bar{y})^2} \pm \Delta \sum$$

where s – the average square deviation, or a quadratic error; $\Delta \sum$ – the total absolute error of measuring systems was determined by the formula:

$$(4.5) \quad \Delta \sum = \pm \sqrt{\sum_i \Delta^2}$$

where $\Delta \sum$ – the total number of errors on all elements of the measuring system; \sum_i – a total error of the i -th element of the system.

Measuring systems presented in Table 1. The maximum permissible measurement error was taken by the permanent value of the average error:

$$(4.6) \quad \Delta n_p = 3s$$

Table 1. Measuring systems

The name of the measured element	Absolute error	Relative error	
		minimal, %	maximal, %
The intensity of thermal radiation (Piranometer M-80M)	$\pm 20 \text{ W/m}^2$	0.20	0.37
Air temperature in the installation zone (ATT thermonemameter – 1004)	$\pm 0.13^\circ\text{C}$	0.18	1.70
Surface temperature (Nimbus – 530/1 pirometer)	$\pm 0.08^\circ\text{C}$	0.14	0.78
Air mobility (ATT thermonemameter – 1004)	$\pm 0.005 \text{ m/s}$	0.60	1.25

If the error exceeded Δn_p , which was calculated $\Delta n_p = 0.17$, then the measurement error was excluded from the calculations and the experiment was repeated. The total error of all measuring systems was 2.1%. Experimental studies to determine the thermal power of the thermosyphon collector for operation in the ventilation mode were carried out in the

range of areas of the ventilation grilles F , m^2 from $0.012 m^2$ to $0.08 m^2$, the thickness of the air layer of the collector δ , m from $0.04 m$ to $0.1 m$, air temperature at the inlet to the collector t_{w1} , $^{\circ}C$ from 19 to $22^{\circ}C$.

Typical results presented in Fig. 6, F_g , m^2 – area of ventilation grilles; Q , kW – the amount of heat received with the help of the Trombe Wall. Where $F_{\delta-1}$ – the area of the ventilation layer $0.036 m^2$; $F_{\delta-2}$ – the area of the ventilation layer $0.063 m^2$; $F_{\delta-3}$ – the area of the ventilation layer $0.09 m^2$; F_g – dimensions of ventilation grilles, m^2 . In Fig. 6 shows the amount of heat received through the Trombe Wall depending on the area of the openings of the ventilation grilles. For the thickness of the ventilation layer of $40 mm$ ($F_{\delta-1}$) with the area of the ventilation opening of $0.056 m^2$, the amount of heat received with the help of the Trombe Wall will be $Q_1 = 546 W$. For the thickness of the ventilation layer of $70 mm$ ($F_{\delta-2}$) with the area of the ventilation hole of $0.056 m^2$, the amount of heat received with the help of the Trombe Wall will be $Q_2 = 432 W$. For the thickness of the ventilation layer of $100 mm$ ($F_{\delta-3}$) with the area of the ventilation opening of $0.056 m^2$, the amount of heat received with the help of the Trombe Wall will be $Q_3 = 663 W$.

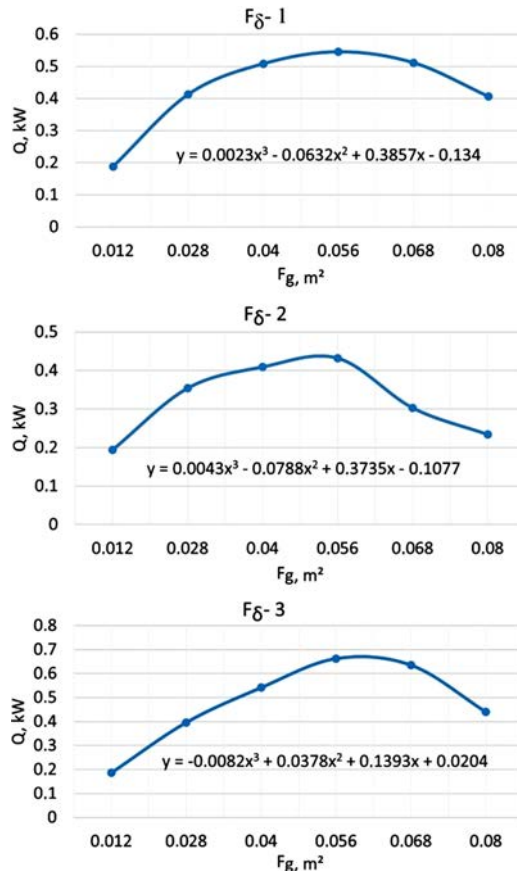

Fig. 6. The amount of heat received with the help of the Trombe Wall

It is clear from the figure that the design has the greatest efficiency with the area of the ventilation grills 0.056 m^2 , namely with overall dimensions $70 \times 800 \text{ mm}$, and at the thickness of the ventilation layer 100 mm .

In addition, the effectiveness of this design was experimentally verified for room ventilation. Thus, in Fig. 7 presents the graphical dependence of air flow L , m^3/h at the area of the ventilation grill $F_g = 0.012 \text{ m}^2$ and the area of the ventilation layer F_δ , m^2 , which made it possible to compare the obtained results with analytical research. Air circulation between the room and the air gap was observed, which confirms heat transfer by convection [54].

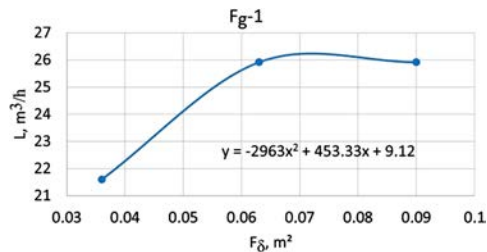

Fig. 7. Dependence of volumetric air flow L , m^3/h from the area of the air layer F_δ , m^2

It can be seen from the figure that with a thickness of the ventilation layer of 0.065 m^2 , the volumetric air consumption is $L = 25.9 \text{ m}^3/\text{h}$, and an increase in this thickness does not affect the change in the amount of ventilation air and will not increase the efficiency of the Trombe Wall.

5. Conclusions

1. The proposed design of the hybrid external protection of the modular house with the Trombe Wall implemented in it confirmed its effectiveness and the ability to perform the functions of an additional heating and ventilation device for systems providing the necessary parameters in the premises of the module. At the same time, this design has no additional operating costs. These systems have the same service life as the house itself. The efficiency of such a heating system, as a rule, is 25–30%, but in particularly favorable climatic conditions it can be much higher and reach 60%.
2. The presented physical model of the phenomenon of free convection, which occurs in the Trombe Wall as a result of its heating by solar radiation, made it possible to draw up a heat-air balance and analytically determine the volume flow of air, which allows you to organize air exchange in the premises by multiples within $1\text{--}1.5 \text{ h}^{-1}$. To generalize with similar models the thermal power of the structure, which is within the limits, is also determined $250 \text{ W}/\text{m}^2$.
3. The thermal characteristics of the proposed design of external protection for a modular house were experimentally investigated and it was established that for the given geometric dimensions, in particular, the volume 14 m^3 the amount of instantaneous heat utilized by Wall Trombe is within the limits $0.2\text{--}0.7 \text{ kW}$.

4. A comparison of graphical dependencies obtained analytically and experimentally confirmed their convergence, which confirms the adequacy of the conducted experiment. The most effective operation of the Trombe Wall, with a working surface of 2.3 m^2 , will be observed for the thickness of the ventilation layer of 100 mm ($F_{\delta-3}$) with the area of the ventilation hole 0.056 m^2 , while the amount of heat received will be $Q_3 = 663 \text{ W}$.
5. The calculation of the measurement error was made, it was established that the total error of all measuring systems was 2.1%.

References

- [1] F. Bre and V.D. Fachinotti, "A computational multi-objective optimization method to improve energy efficiency and thermal comfort in dwellings", *Energy and Buildings*, vol. 154, pp. 283–294, 2017, doi: [10.1016/j.enbuild.2017.08.002](https://doi.org/10.1016/j.enbuild.2017.08.002).
- [2] S. Firląg, A. Miszczuk, and B. Witkowski, "Analysis of climate change and its potential influence on energy performance of building and indoor temperatures. Part 2: Energy and thermal simulation", *Archives of Civil Engineering*, vol. 69, no. 2, pp. 195–209, 2023, doi: [10.24425/ace.2023.145263](https://doi.org/10.24425/ace.2023.145263).
- [3] M. Kasynets, K. Kozak, B. Piznak, and I. Venhryn, "Enhancing of efficiency of solar panels combined with buildings coating", in *Lecture Notes in Civil Engineering*, vol. 290. Springer, 2023, pp. 136–149.
- [4] V. Zhelykh, P. Shapoval, S. Shapoval, and M. Kasynets, "Influence of orientation of buildings facades on the level of solar energy supply to them", in *Lecture Notes in Civil Engineering*, vol. 100. Springer, 2021, pp. 449–504.
- [5] S. Shapoval, V. Zhelykh, I. Venhryn, K. Kozak, and R. Krygu, "Theoretical and experimental analysis of solar enclosure as part of energy-efficient house", *Eastern-European Journal of Enterprise Technologies*, vol. 2, no. 8(98), pp. 38–45, 2019, doi: [10.15587/1729-4061.2019.160882](https://doi.org/10.15587/1729-4061.2019.160882).
- [6] T. Salem, N. Metni, M. Kazma, and H. Hanna, "Numerical investigation of the impact of integrating solar collectors under stagnation", presented at the 2020 5th International Conference on Renewable Energies for Developing Countries, REDEC 2020.
- [7] B. Koua, P.M.E. Koffi, and P. Gbaha, "Comparative study of the thermal performance of two thermosiphon solar water heaters system", *International Journal of Renewable Energy Development*, vol. 9, no. 3, pp. 401–410, 2020, doi: [10.14710/ijred.2020.30575](https://doi.org/10.14710/ijred.2020.30575).
- [8] F. Peci, F. Taboas, F. Comino, and M. Ruiz de Adana, "Experimental study of a modular unglazed transpired collector façade for building refurbishment", *Solar Energy*, vol. 201, pp. 247–258, 2020, doi: [10.1016/j.solener.2020.02.103](https://doi.org/10.1016/j.solener.2020.02.103).
- [9] A. Hamburg, K. Kuusk, A. Mikola, and T. Kalamees, "Realisation of energy performance targets of an old apartment building renovated to nZEB", *Energy*, vol. 194, art. no. 116874, 2020, doi: [10.1016/j.energy.2019.116874](https://doi.org/10.1016/j.energy.2019.116874).
- [10] P. Bevilacqua, R. Bruno, J. Szyszka, D. Cirone, and A. Rollo, "Summer and winter performance of an innovative concept of Trombe Wall for residential buildings", *Energy*, vol. 258, art. no. 124798, 2022, doi: [10.1016/j.energy.2022.124798](https://doi.org/10.1016/j.energy.2022.124798).
- [11] L. Moosavi, S. Alidoost, F. Norouzi, S. Sattary, and S. Banihashemi, "Trombe Wall's thermal and energy performance – A retrofitting approach for residential buildings in arid climate of Yazd, Iran", *Journal of Renewable and Sustainable Energy*, vol. 14, no. 4, 2022, doi: [10.1063/5.0089098](https://doi.org/10.1063/5.0089098).
- [12] S.M. Tabarhoseini and M. Sheikholeslami, "Modeling of evacuated tube solar collector involving longitudinal fins and nanofluids", *Sustainable Energy Technologies and Assessments*, vol. 53, art. no. 102587, 2022, doi: [10.1016/j.seta.2022.102587](https://doi.org/10.1016/j.seta.2022.102587).
- [13] S. Awani, R. Chargui, and B. Tashtoush, "Experimental and numerical evaluation of a new design of a solar thermosiphon water heating system with phase change material", *Journal of Energy Storage*, vol. 41, art. no. 102948, 2021, doi: [10.1016/j.est.2021.102948](https://doi.org/10.1016/j.est.2021.102948).

- [14] A.R. Kalair, M. Seyedmahmoudian, M.S. Saleem, N. Abas, S. Rauf, and A. Stojcevski, "A comparative thermal performance assessment of various solar collectors for domestic water heating", *International Journal of Photoenergy*, vol. 2022, art. no. 9536772, pp. 1–17, 2022, doi: [10.1155/2022/9536772](https://doi.org/10.1155/2022/9536772).
- [15] M. Kunelbayev, T. Ormanov, T. Sundetov, and M. Amirgaliyev, "Mathematical substantiation of principal parameters of thermosiphon effect for solar heating", presented at 2nd International Conference on Electrical, Communication and Computer Engineering, ICECCE 2020.
- [16] H. Biglarian, M.M. Sharfabadi, M. Alizadeh, and H. Gharaei, "Performance investigation of solar thermal collector with auxiliary heater for space heating", *Journal of Central South University*, vol. 28, no. 11, pp. 3466–3476, 2021.
- [17] M. Eltaweel, A.A. Abdel-Rehim, and H. Hussien, "Indirect thermosiphon flat-plate solar collector performance based on twisted tube design heat exchanger filled with nanofluid", *International Journal of Energy Research*, vol. 44, no. 6, pp. 4269–4278, 2020, doi: [10.1002/er.5146](https://doi.org/10.1002/er.5146).
- [18] O.R. Alomar, H.M. Abd, and M.M. Mohamed Salih, "Efficiency enhancement of solar air heater collector by modifying jet impingement with v-corrugated absorber plate", *Journal of Energy Storage*, vol. 55, art. no. 105535, 2022, doi: [10.1016/j.est.2022.105535](https://doi.org/10.1016/j.est.2022.105535).
- [19] S.A.M. Burek and A. Habeb, "Air flow and thermal efficiency characteristics in solar chimneys and Trombe Walls", *Energy and Buildings*, vol. 39, no. 2, pp. 128–135, 2007, doi: [10.1016/j.enbuild.2006.04.015](https://doi.org/10.1016/j.enbuild.2006.04.015).
- [20] G. He, "A general model for predicting the airflow rates of a vertically installed solar chimney with connecting ducts", *Energy and Buildings*, vol. 229, art. no. 110481, 2020, doi: [10.1016/j.enbuild.2020.110481](https://doi.org/10.1016/j.enbuild.2020.110481).
- [21] C. W. Adihou, A.A. Djossou, E.C. Vodounnou, C. Awanto, C.A. Houngan, and M. Anjorin, "Comparative study of the energy performance of two thermosiphon solar collectors with different water channels: Channel in round tubes and channel under flat plate", presented at the International Conference on Electrical, Computer, and Energy Technologies, ICECET 2021.
- [22] Y. Amirgaliyev, M. Kunelbayev, T. Ormanov, T. Sundetov, and S. Daulbayev, "Comparative analysis of a flat solar collector and flat solar collector with chemical coating", *Thermal Science*, vol. 26, no. 1, pp. 147–156, 2022, doi: [10.2298/TSCI201108173A](https://doi.org/10.2298/TSCI201108173A).
- [23] J. Vera-Medina, C. Fernandez-Peruchena, J. Guasumba, and I. Lillo-Bravo, "Performance analysis of factory-made thermosiphon solar water heating systems", *Renewable Energy*, vol. 164, pp. 1215–1229, 2021, doi: [10.1016/j.renene.2020.10.133](https://doi.org/10.1016/j.renene.2020.10.133).
- [24] M. Eltaweel and A.A. Abdel-Rehim, "Energy and exergy analysis of a thermosiphon and forced-circulation flat-plate solar collector using MWCNT/Water nanofluid", *Case Studies in Thermal Engineering*, vol. 14, 2019, doi: [10.1016/j.csite.2019.100416](https://doi.org/10.1016/j.csite.2019.100416).
- [25] Y. Amirgaliyev, M. Kunelbayev, and T. Sundetov, "Calculation of the energy of a two-circuit solar system with thermosiphon circulation based on the internet of things", in *Computational intelligence techniques for green smart cities. green energy and technology*, M. Lahby, A. Al-Fuqaha, and Y. Maleh, Eds. Springer, 2022, pp. 321–333, doi: [10.1007/978-3-030-96429-0_15](https://doi.org/10.1007/978-3-030-96429-0_15).
- [26] M. Çimen, M. Colakoglu, and A. Güngör, "Overheating limitation of thermosiphon solar collectors by controlling heat pipe fluid in all glass evacuated tubes", *Solar Energy*, vol. 230, pp. 515–527, 2021, doi: [10.1016/j.solener.2021.10.066](https://doi.org/10.1016/j.solener.2021.10.066).
- [27] M. Grosso, G. Fracastoro, M. Simonetti, and G. Chiesa, "A hybrid passive cooling wall system: Concept and laboratory testing results", *Energy Procedia*, vol. 78, pp. 79–84, 2015, doi: [10.1016/j.egypro.2015.11.118](https://doi.org/10.1016/j.egypro.2015.11.118).
- [28] V. Zhelykh, I. Venhryn, K. Kozak, and S. Shapoval, "Solar collectors integrated into transparent facades", *Production Engineering Archives*, vol. 26, no. 3, pp. 84–87, 2020, doi: [10.30657/pea.2020.26.17](https://doi.org/10.30657/pea.2020.26.17).
- [29] S. Manu, G. Brager, and A. Dennis, "Performance evaluation of climate responsive buildings in India: Two case studies from hot-dry and composite climate zones", in *Proceedings of 33rd PLEA International Conference: Design to Thrive – PLEA 2017*, vol. 3. NCEUB, 2017, pp. 4164–4171.
- [30] H. Mastouri, B. Benhamou, H. Hamdi, and E. Mouyal, "Thermal performance assessment of passive techniques integrated into a residential building in semi-arid climate", *Energy and Buildings*, vol. 143, pp. 1–16, 2017, doi: [10.1016/j.enbuild.2017.03.022](https://doi.org/10.1016/j.enbuild.2017.03.022).
- [31] Z.D. Chen, P. Bandopadhyay, J. Halldorsson, C. Byrjalsen, P. Heiselberg, and Y. Li, "An experimental investigation of a solar chimney model with uniform wall heat flux", *Building and Environment*, vol. 38, no. 7, pp. 893–906, 2003, doi: [10.1016/S0360-1323\(03\)00057-X](https://doi.org/10.1016/S0360-1323(03)00057-X).

- [32] M. Sandberg and B. Moshfegh, "Ventilated-solar roof air flow and heat transfer investigation", *Renewable Energy*, vol. 15, no. 1–4, pp. 287–292, 1998.
- [33] M. Ulewicz, V. Zhelykh, K. Kozak, and Y. Furdas, "Application of thermosiphon solar collectors for ventilation of premises", in *Advances in Resource-saving Technologies and Materials in Civil and Environmental Engineering. Proceedings of CEE 2019*. Springer, 2020, doi: [10.1007/978-3-030-27011-7_23](https://doi.org/10.1007/978-3-030-27011-7_23).
- [34] V. Zhelykh, C. Kozak, and O. Savchenko, "Using of thermosiphon solar collector in an air heating wystem of passive house", *Pollack Periodica*, vol. 11, no. 2, pp. 125–133, 2016, doi: [10.1556/606.2016.11.2.11](https://doi.org/10.1556/606.2016.11.2.11).
- [35] Y. Liu, Z. Yu, C. Song, and D. Wang, "Heating load reduction characteristics of passive solar buildings in Tibet, China", *Building Simulation*, vol. 15, no. 6, pp. 975–994, 2022.
- [36] M. Ulewicz, V. Zhelykh, K. Kozak, and Y. Furdas, "Application of thermosiphon solar collectors for ventilation of premises", in *Proceedings of CEE 2019. Lecture Notes in Civil Engineering*, vol. 47. Springer, 2020, pp. 180–187.
- [37] M. Jalalpour and C. Nnaji, "Investigating the impact of Trombe wall on building energy saving and thermal comfort – case study", in *Proceedings of the Canadian Society of Civil Engineering Annual Conference 2021. Lecture Notes in Civil Engineering*, vol. 247. Springer, 2023, pp. 577–586.
- [38] S. Zhou and A.G. Razaqpur, "Efficient heating of buildings by passive solar energy utilizing an innovative dynamic building envelope incorporating phase change material", *Renewable Energy*, vol. 197, pp. 305–319, 2022, doi: [10.1016/j.renene.2022.07.073](https://doi.org/10.1016/j.renene.2022.07.073).
- [39] V. Zhelykh, M. Ulewicz, Y. Furdas, M. Adamski, and M. Rebman, "Investigation of pressure coefficient distribution on the surface of a modular building", *Energies*, vol. 15, no. 13, art. no. 4644, 2022, doi: [10.3390/en15134644](https://doi.org/10.3390/en15134644).
- [40] K.A. Alharbi, O. Aldosari, H. Sina, H.S. Aybar, S. Fuxi, S.E. Alkhatib, and A.A.A Mousa, "Installation of rectangular enclosures filled with phase change nanomaterials on the Trombus walls of a residential building to manage solar radiation in different seasons of the year", *Journal of Building Engineering*, vol. 57, 2022, doi: [10.1016/j.jobe.2022.104732](https://doi.org/10.1016/j.jobe.2022.104732).
- [41] L. Xiao, L. Qin, and S.Y. Wu, "Proposal and application of comprehensive thermal comfort evaluation model in heating seasons for buildings with solar Trombe wall", *Applied Thermal Engineering*, vol. 213, art. no. 118774, 2022, doi: [10.1016/j.applthermaleng.2022.118774](https://doi.org/10.1016/j.applthermaleng.2022.118774).
- [42] F. Abbassi, N. Naili, and L. Dehmani, "Optimum Trombe wall thickness in the Mediterranean Tunisian Context: An energetic and economic study", *Energy Science and Engineering*, vol. 10, no. 8, pp. 2930–2939, 2022, doi: [10.1002/ese3.1179](https://doi.org/10.1002/ese3.1179).
- [43] D. Liang, M. Ibrahim, T. Saeed, A.M. El-Refaey, Z. Li, and M.A. Fagiry, "Simulation of a Trombe wall with a number of semicircular fins placed on the absorber plate for heating a room in the presence of nano-PCM", *Journal of Building Engineering*, vol. 50, art. no. 104173, 2022, doi: [10.1016/j.jobe.2022.104173](https://doi.org/10.1016/j.jobe.2022.104173).
- [44] D. Fidaros, C. Baxevanou, M. Markousi, and A. Tsangrassoulis, "Assessment of various Trombe wall Geometries with CFD Study", *Sustainability*, vol. 14, no. 9, art. no. 4877, 2022, doi: [10.3390/su14094877](https://doi.org/10.3390/su14094877).
- [45] H. Chen, S. Liu, M. Eftekhari, Y. Li, W. Ji, and Y. Shen, "Experimental studies on the energy performance of a novel wavy-shape Trombe wall", *Journal of Building Engineering*, vol. 61, art. no. 105242, 2022, doi: [10.1016/j.jobe.2022.105242](https://doi.org/10.1016/j.jobe.2022.105242).
- [46] M. Rabani, "Experimental comparison of energy and energy analysis of a new Designed and a normal Trombe wall", *Energy*, vol. 260, art. no. 125050, 2022, doi: [10.1016/j.energy.2022.125050](https://doi.org/10.1016/j.energy.2022.125050).
- [47] S.Y. Wu, R.R. Yan, and L. Xiao, "A novel passive solar vertical-finned-thermo catalytic -Trombe wall system for air purification and heating", *Journal of Cleaner Production*, vol. 374, art. no. 134065, 2022, doi: [10.1016/j.jclepro.2022.134065](https://doi.org/10.1016/j.jclepro.2022.134065).
- [48] A. Mokni, A. Lashin, M. Ammar, and H. Mhiri, "Thermal analysis of a Trombe wall in various climatic conditions: An experimental study", *Solar Energy*, vol. 243, pp. 247–263, 2022, doi: [10.1016/j.solener.2022.08.011](https://doi.org/10.1016/j.solener.2022.08.011).
- [49] J. Čurpek and M. Čekon, "A simple Trombe wall enhanced with a phase change material: Building Performance Study", in *Sustainability in Energy and Buildings 2021. Smart Innovation, Systems and Technologies*, vol. 263. Springer, 2022, pp. 281–291.

- [50] P. Bevilacqua, R. Bruno, J. Szyszka, D. Cirone, and A. Rollo, “Summer and winter performance of an innovative concept of Trombe Wall for residential buildings”, *Energy*, vol. 258, art. no. 124798, 2022, doi: [10.1016/j.energy.2022.124798](https://doi.org/10.1016/j.energy.2022.124798).
- [51] J. Szyszka, P. Bevilacqua, and R. Bruno, “An innovative Trombe wall for winter use: The thermo-diode Trombe Wall”, *Energies*, vol. 13, art. no. 2188, 2020, doi: [10.3390/en13092188](https://doi.org/10.3390/en13092188).
- [52] R. Bruno, P. Bevilacqua, D. Cirone, S. Perrella, and A. Rollo, “A calibration of the solar load ratio method to determine the heat gain in PV-Trombe walls”, *Energies*, vol. 15, no. 1, art. no. 328, 2022, doi: [10.3390/en15010328](https://doi.org/10.3390/en15010328).
- [53] O. Voznyak and V. Zhelykh, *Basics of scientific research in construction*. Lviv: Publication of Lviv Polytechnic University, 2003.
- [54] J. Błotny and M. Nemš, “Analysis of the impact of the construction of a Trombe wall on the thermal comfort in a building located in Wrocław, Poland”, *Atmosphere*, vol. 10, no. 12, art. no. 761, 2019, doi: [10.3390/atmos10120761](https://doi.org/10.3390/atmos10120761).

Received: 2023-06-09, Revised: 2023-09-05