

JAN MRÓZ*

INVESTIGATIONS OF FeO REDUCTION FROM LIQUID SLAGS OF CaO-FeO-SiO₂ TYPEBADANIA REDUKCJI FeO Z CIEKLYCH ŻUŻLI TYPU CaO-FeO-SiO₂

The reduction of iron oxides from liquid slags is the fundamental stage of many newly developed, future-oriented technologies of obtaining liquid iron (pig iron), which are referred to as reduction iron smelting processes, whose main distinguishing feature is the use of non-coking coals. The reduction processes in those technologies are heterogeneous processes in which the following phases take part: a solid phase (carbon reducer), a liquid phase (molten iron oxides in the slag), and a gaseous phase (carbon monoxide and carbon dioxide). This is the reason for the complexity of the reduction process mechanism, which makes the kinetic description of these reaction difficult.

In the present study, a methodology of examining the reduction was adopted using the so called graphite rotating disk.

The investigations carried out within the present study were aimed to determine the kinetic area for the reduction of iron oxides in the temperature range of 1350–1420°C in the CaO-FeO-SiO₂ slags and with an FeO content from 20 to 60% by weight, with the use of a graphite reducer, as well as to evaluate the kinetic parameters of the process.

The applied methodology of the rotating disk tests has enabled a conclusion to be drawn of the suitability of this method for identifying the kinetic area of reduction in most of the reduction variants used. It has been found that for slags with a basicity from 0.31 to 1.53 and in the viscosity range from 4.23 to 0.31 dPa·s the reduction rate is determined by the diffusion of FeO to the slag-reducer interface.

Parameters of the kinetic diffusion area have been calculated, such as: FeO diffusion coefficient, the limiting diffusion layer thickness and mass transfer coefficient. The analysis of the calculated values of FeO diffusion coefficients made based on the available literature data indicates that these should be regarded as specific for the diffusion coefficients of oxygen ions in the liquid slag.

The determined mass transfer coefficients have enabled the reduction rate to be calculated for particular variants of reduction. A good agreement with the experimental results has been obtained at low disc rotations.

* WYDZIAŁ METALURGII I INŻYNIERII MATERIAŁOWEJ, POLITECHNIKA CZĘSTOCHOWSKA, 42-200 CZĘSTOCHOWA, AL. ARMII KRAJOWEJ 19

Redukcja tlenków żelaza z ciekłych żużli jest podstawowym etapem wielu nowo rozwijanych, przyszłościowych technologii otrzymywania ciekłego żelaza (surówki), określanych mianem wytapiania redukcyjnego, których główną cechą jest wykorzystanie niekoksujących węgla kamiennych. Procesy redukcji w tych technologiach są procesami heterogenicznymi w których biorą udział następujące fazy: faza stała (reduktor węglowy), faza ciekła (ciekle żelazo i żużel) i faza gazowa (tlenek i dwutlenek węgla). Jest to przyczyną złożoności mechanizmu procesu redukcji i trudności opisu tego mechanizmu.

W obecnych badaniach redukcji FeO z ciekłych żużli zaadoptowano metodykę wirującego dysku, w tym przypadku dysku grafitowego.

Badania przeprowadzone w niniejszej pracy miały na celu określenie obszaru kinetycznego redukcji FeO w zakresie temperatur 1350–1420°C z żużli typu CaO-FeO-SiO₂ z zawartością 20 i 60 % FeO i określenie parametrów kinetycznych procesu.

Zastosowana metodyka wirującego dysku pozwoliła stwierdzić jej przydatność do identyfikacji obszaru kinetycznego redukcji w większości stosowanych wariantów redukcji. Stwierdzono, że w przypadku badanych żużli o zasadowości od 0,31 do 1,53 i zakresie lepkości od 4,23 do 0,31 dPa-s szybkość redukcji jest określona przez dyfuzję FeO w żużlu.

Obliczono takie parametry kinetyczne redukcji jak: współczynniki dyfuzji FeO, grubość granicznej warstwy dyfuzyjnej i współczynniki przenoszenia masy.

Analiza wartości obliczonych współczynników dyfuzji FeO i ich weryfikacja na podstawie dostępnych danych literaturowych wskazuje, że należy je interpretować jako charakterystyczne dla współczynników dyfuzji jonów tlenkowych O²⁻ w ciekłym żużlu.

Określone współczynniki przenoszenia masy pozwoliły obliczyć szybkość redukcji dla poszczególnych wariantów redukcji. Stwierdzono dobrą zgodność wyników obliczonych z wynikami eksperymentalnymi w zakresie niskich obrotów dysku 100 i 400 obr/min.

1. Introduction

The reduction of iron oxides from liquid slags is the basic stage of many newly developed prospective technologies of obtaining liquid iron (pig iron), whose main distinctive feature is the use of non-coking grades of hard coal [1–7]. In this connection, particularly intensive development of research work on the reduction of iron oxides from liquid phases has been observed in the last decade or so. In addition, part of iron oxides (approx. 20–30%) is reduced from liquid slags also in the blast-furnace process; too intensive development of this reaction may, however, lead to disturbances in the flow of gases and the descending of the charge. Investigations on the reduction of iron oxides from liquid slag phases are thus more universal in character, and the results of this work may have a concrete relationship also with the blast-furnace technology of iron production.

The processes of reduction of iron oxides in the liquid state are heterogeneous processes, where the following phases participate: a solid phase (a carbon reducer), a liquid phase (molten iron oxides), and a gaseous phase (carbon monoxide and carbon dioxide). This is the cause of the complexity of the reduction process mechanism and contributes to the difficulty in the kinetic description of those reactions. The results of previously conducted studies have shown that the mass transfer, and chiefly the diffusion of FeO in the slag phase [8–15] and Boudouard's reaction [16–20] are

the most likely factors limiting the reduction of iron oxides from the liquid phase using a solid carbon reducer.

In the case where the reduction process proceeds in the region of control by the diffusion of FeO in the bulk of slag, the quantitative evaluation of the basic kinetic parameters for this region (i.e. the diffusion coefficient and the mass transfer coefficient) as a function of slag viscosity becomes difficult because of the lack of sufficient theoretical principles that would define those relationships. The relationships between the viscosity of the liquid and the diffusion coefficient as given by Stokes-Einstein, Eyring [21], do not yield satisfactory results with regard to metallurgical slags due to the limitations related to the size of diffusing molecules and the average interatomic distances. Hence, the investigation of reduction using the rotating disc theory [22,23] was performed within the works on the reduction of iron oxides from the liquid phase conducted in the Department of Metals Extraction and Recirculation. This theory provides both bases for the unequivocal definition of the kinetic region of the reaction and the capability of determining the diffusion coefficient as dependent on the slag viscosity and the unit reduction rate.

2. Principles of the methodology of investigations using the rotating disc

The rotating disc theory developed by Levich [22] makes it possible to determine the diffusion coefficient of the reagent and the laminar diffusion layer thickness. According to this theory, unit diffusion flux is defined by the following relationship:

$$j_i = 0.62 \cdot D_i^{2/3} \cdot \nu^{-1/6} \cdot \omega^{1/2} \cdot c_o, \quad (1)$$

where:

j_i – unit diffusion flux of the reagent i , mole · cm⁻² · s⁻¹,

D_i – diffusion coefficient of the reagent i , cm²/s,

ν – kinematic viscosity of the solution, cm²/s,

ω – angular velocity, rad/s, while: ($\omega = 2\pi m$, where: m – number of disk rotations per second),

c_o – concentration of the reagent i in the liquid volume, mole/cm³.

Knowing the diffusion coefficient D , the laminar layer thickness, δ , can be determined from relationship (1):

$$\delta = 1.61 \cdot D^{1/3} \cdot \nu^{1/6} \cdot \omega^{-1/2}. \quad (2)$$

Methodology of rotating disc developed by Levich is widely used in the research work in electrochemistry first of all. As the presented relationships are valid in the wide range of Reynolds' number from 10 to 10⁴, (and up to 10⁵ for a well centered and polished disc), this methodology may be adapted in metallurgical investigations too [24–26].

Moreover, this theory enables the direct identification of the kinetic region of the process in the coordinate system process rate – square root of the number of disc

rotations per second. In the diffusion region, the process rate is proportional to the parameter \sqrt{m} , and in the case of activation control the process rate does not depend on the rate of agitation [27].

For the rotating disc, Reynolds' number is defined by the following expression: (3)

$$\text{Re} = \frac{\omega \cdot r^2}{\nu}, \quad (3)$$

where:

r – disc radius, cm;

ω – disc angular speed, $\text{rad} \cdot \text{s}^{-1}$;

ν – liquid kinematic viscosity, $\text{cm}^2 \cdot \text{s}^{-1}$.

3. Experimental investigations of FeO reduction using a graphite rotating disc

The investigations on the reduction of FeO were conducted in the CaO-FeO-SiO₂ ternary slag system at temperatures of 1350°C and 1420°C, and with FeO contents of 20% and 60%. The basicity of slags, as defined by the CaO/SiO₂ ratio, was preset at the level of 0.31, 0.94 and 1.53. The appropriate amounts of CaO and SiO₂ had been previously blended, and then melted in graphite crucibles, while being heated up to the temperature of 1500°C at a rate of 10 K/min. Ferrous oxide was obtained by melting pure Fe₂O₃ with pure analytical iron (powdered carbonyl iron) in the proper proportion in an iron crucible, at 1480°C. According to chemical analysis, the obtained ferrous oxide melt corresponds stoichiometrically to the formula Fe_{0.96}O (in the further text presented as FeO).

The reduction tests were conducted on a research stand shown in Figure 1. A sample of slag with FeO with a total mass of 50 g was placed in the iron crucible with an inner diameter of 40 mm and a height of 80 mm, which was then inserted into the alundum retort of a Tamman furnace. An alundum shield with inner and outer surfaces polished to the accuracy of 0.1 mm was placed on the graphite reducer in the form of a 45 mm-long bar with a diameter of 19.5 mm. The reaction surface is made up in this case by the flat end face of the bar, which in the further part of this article is referred to as the disc. The graphite disc is mounted on a molybdenum rod bearing-seated in a graphite sleeve. This sleeve constitutes, at the same time, a closure of the alundum reaction retort in the Tamman furnace. The rotations of the graphite bar are counted by a photoelectric sensor mounted above the rotating disk of the driving motor.

The experiment was conducted as follows: after the sample had been inserted in the furnace and the alundum retort had been closed using the graphite sleeve with the molybdenum rod and the graphite disc, an argon flow of 118 dcm³/h was passed through the system, and the sample was heated up to desired temperature. After reaching the preset temperature, the sample was kept at that temperature for 10 minutes. Then, the graphite bar was lowered to a depth of 7 mm above the bottom of the iron crucible. For

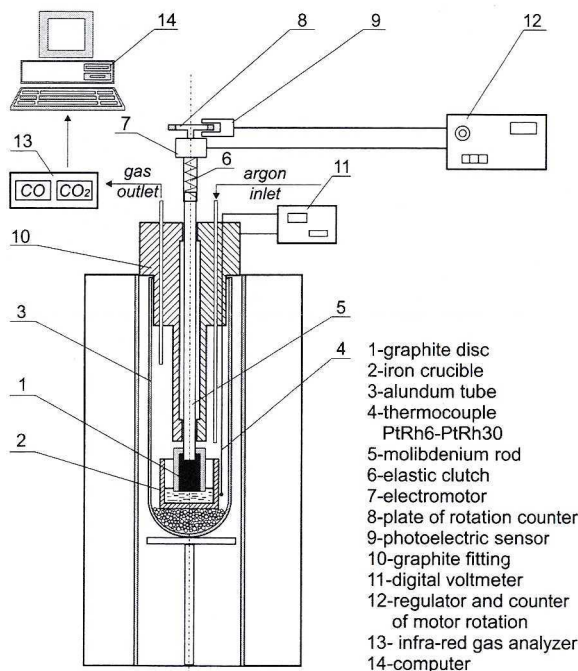

Fig. 1. Schematic diagram of research stand

the first 120 seconds, the reduction was run with the disc in a stationary state, then the reduction conducted using disc rotations of 100, 400, 800, 1200, 1600, and 2000 rev/min. followed at intervals of 120 s. The reduction rate was indicated by an automatic carbon monoxide and dioxide analyser. A computer was connected to the system, that recorded the readings of the analyser in 10 s intervals.

Since the kinematic viscosity of slags is necessary for the elaborating of results according to the rotating disc theory [22], the dynamic viscosity of these slags was calculated using the model proposed by the authors of [28] for the CaO-FeO-SiO_2 system. Figure 2 shows the relationship of dynamic viscosity versus temperature for the slags under consideration.

The density of slag of 20% FeO was calculated according to the model and data as proposed by the authors of [29], and for the slag of 60% FeO was determined using the data given by K. C. Mills and B. J. Keene [21,30]. The density of slag of 20% FeO and of basicity 0.94 was estimated to be 3.01 and 2.99 g/cm^3 at the temperatures of 1350 and 1420°C respectively, whereas for the basicity of 1.53 the density was calculated to be 3.20 and 3.26 g/cm^3 at the same temperatures respectively.

In the case of slags of 60% FeO the density both of slag of basicity 0.31 and 1.53 was estimated to be 3.57 and 3.55 g/cm^3 for the temperatures of 1350 and 1420°C, respectively.

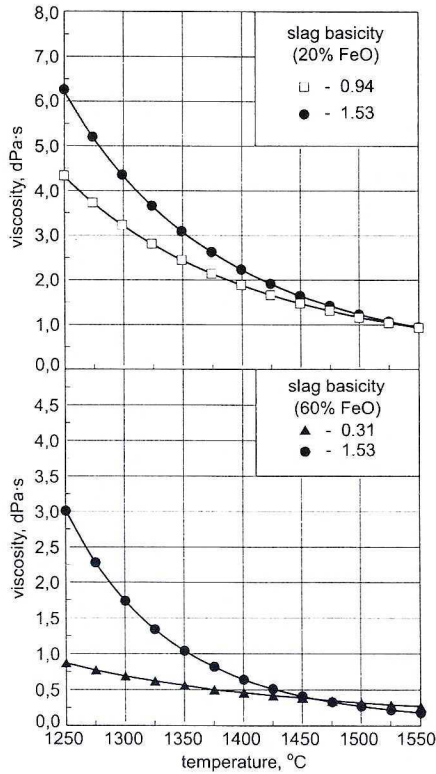

Fig. 2. Calculated viscosity of CaO-FeO-SiO₂ slags as function of temperature for given basicity and FeO contents

3.1. Results and discussion of the research results

3.1.1. Reduction rate as a function of time and disc rotation

The source results of reduction in the form of the concentration of CO and CO₂ in the carrier gas, i.e. argon, were processed into the amount of reduced FeO expressed in mole · cm⁻² · s⁻¹ (slight amounts of carbon dioxide occurred in the reaction system only in the case of reduction from slag with 60% FeO and a basicity of 1.53).

Figures 3 and 4 shows the course of the reduction of FeO from the slags investigated. The diagram depicts the reduction rate as a function of time and as dependent on the disc rotational speed. The first 120 seconds of reduction correspond to the stationary state of the disc and are a reference point for the evaluation of the effect of rotation on the proceeding reduction.

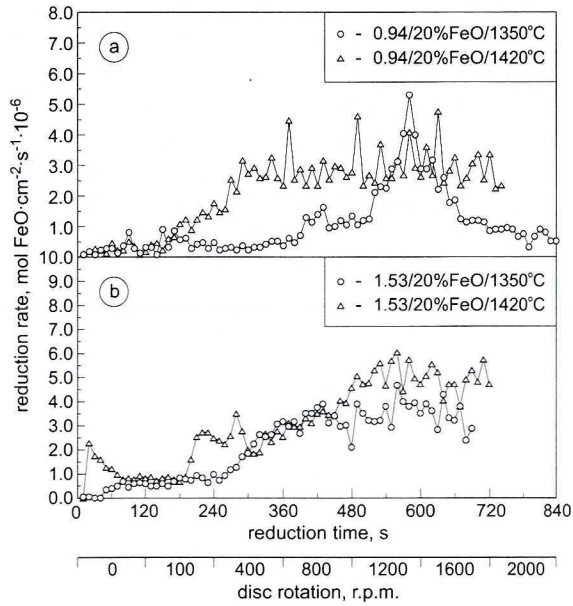

Fig. 3. Reduction rate vs time and disc rotation at temperature 1350 and 1420°C for given slag basicities (20% FeO)

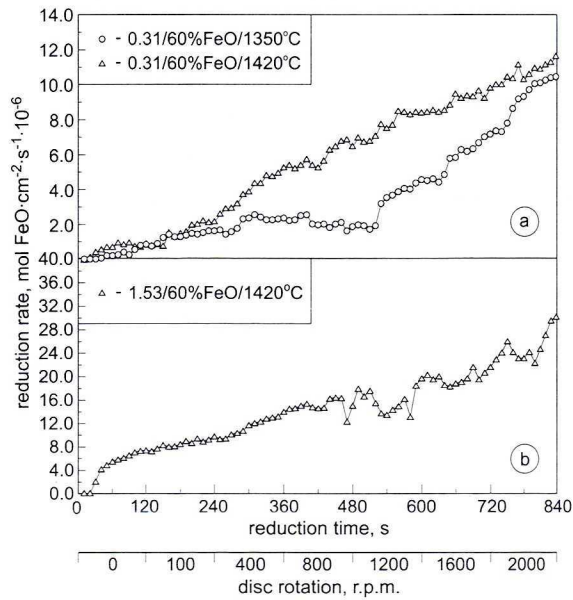

Fig. 4. Reduction rate vs time and disc rotation at temperature 1350 and 1420°C for given slag basicities (60% FeO)

As can be seen from Figure 3, the reduction process is characterized by high variation of the rate, and for this reason the data have also been presented in the form of mean values (Table 1) in each 120-second interval of the reduction. The mean reduction rate was determined in the following manner: of twelve reduction rate data for each 120-second interval, the last 7 measurements were taken in each of those intervals to avoid any possible effect of the reduction conditions from the preceding interval. Of these seven data, two data (the minimum and maximum values) were rejected, and the mean value was determined.

TABLE 1
The average reduction rate ($\text{mol FeO} \cdot \text{cm}^{-2} \cdot \text{s}^{-1} \cdot 10^{-6}$) at given disc rotations, slag basicities, temperatures and FeO contents in slag

Disc rotation r.p.m.	20% FeO				60% FeO		
	1350°C		1420°C		1350°C	1420°C	
	Slag basicity, CaO/SiO ₂				Slag basicity, CaO/SiO ₂		
	0.94	1.53	0.94	1.53	0.31	0.31	1.53
0	0.33	0.87	0.53	1.20	0.54	0.86	6.48
100	0.36	1.82	1.21	3.40	1.57	2.00	9.10
400	0.31	2.62	2.64	4.40	2.42	4.67	12.69
800	1.12	3.25	2.72	3.86	2.02	6.34	14.98
1200	3.34	3.81	2.75	2.71	4.08	8.25	15.46
1600	1.11	–	2.92	2.39	6.55	9.40	20.08
2000	0.58	–	–	–	10.14	10.95	25.65

A characteristic feature of proceeding reduction from the slag with the 20% content of FeO, as compared with reduction from slags containing 60% FeO, is the occurrence of considerable momentary fluctuations in the reduction rates. The explanation of this phenomenon should be sought in the probable difference in the sizes of the bubbles of gaseous reduction products. In the case of FeO reduction from the 20% FeO slag, there should be a tendency to the formation of less numerous but larger bubbles, whereas during reduction from the 60% FeO slag conditions should exist, which will reduce the bubble diameter and increase the number of bubbles. The analysis of basic factors determining the sizes of gas bubbles, i.e. the metal-slag interfacial tension and the slag viscosity, confirm this presumption and is discussed in work [31,32].

3.1.2. Determination of FeO diffusion coefficients in the liquid slag and the limiting thickness of the diffusion layer

As it was mentioned earlier, according to the rotating disk theory [22] the diagram of the relationship of the reduction rate versus the square root of revolutions per second,

\sqrt{m} ($m = \text{rev/s}$), enables the interpretation of the kinetic region of the process under examination. The occurrence of a directly proportional dependence of the reduction rate on the square root of disk revolutions per second implies the existence of a region controlled by diffusion.

The examined dependencies of the reduction rates on \sqrt{m} were evaluated using the linear regression criterion in the domain of monotonically increasing values, that is any areas of decreasing reduction rate were excluded from the evaluation. Moreover, it was assumed for the initial parameter value of $\sqrt{m} = 0$ that also the reduction rate is $r = 0$, and – in accordance with the assumptions of the rotating disk theory for the diffusion region – a linear approximation model of $y = ax$ type passing through the origin on the coordinate system was employed. This assumption (i. e. $r = 0$ if $\sqrt{m} = 0$) results from the fact, that in the diffusion controlled region, with no agitation of reagents, the reaction rate should be equal to zero (specific reaction rate that often occur at the beginning of the process, with any agitation, should be ascribed to the occurrence of some amounts of reagents at the interfacial surface).

Figures 5 and 6 show the dependence of the reduction rate on the parameter \sqrt{m} at the temperatures 1350°C and 1420°C from the slags containing 20 and 60% FeO, respectively. A distinct linear dependence of the reduction rate on the parameter \sqrt{m} is visible on these diagrams, which indicates that the reduction is controlled by mass transfer in the liquid slag, and specifically by the diffusion transfer of FeO. However, in the case of FeO reduction from the slag of basicity 0.94 at temp. 1350°C and 20% FeO content (Fig. 5a), and from the slag of basicity of 0.31 at temp. 1350°C and 60% FeO content (Fig. 6a), there is no bases to make conclusion of linear dependence of the reduction rate on the parameter \sqrt{m} . At present it is difficult to explain this phenomenon unequivocally. As the most probable reason one can assume the momentary occurrence of metallic iron on the reducer surface.

The high degree of linear correlation between the reduction rate and the parameter \sqrt{m} forms grounds for using relationships (1) and (2) to determine the value of the diffusion coefficient, D , and the thickness of the limiting diffusion layer, δ .

Parameters necessary for this purpose, i.e. the unit flux of FeO diffusion, j , the kinematic viscosity of slags, ν , disc angular speed, ω , and the FeO concentration in the bulk of slag, c_0 , are summarized in Tables 2 and 3.

The values of unit diffusions fluxes, j , have been assumed – on the condition of pure diffusion control – to be equivalent to unit reduction rates. The assumption of the exclusive control of the reduction reaction by the diffusion of FeO is justified by the linear character of the relationship between the reduction rate and the parameter \sqrt{m} . The values of unit diffusion fluxes shown in Tables 2 and 3 are not, however, experimental values, since they undergo, as can be seen in Figures 3 and 4, some fluctuations associated most probably with the variable conditions of the formation and release of gaseous reaction products in the form of bubbles. Taking these experimental values for the calculation of the parameters D and δ would carry this experimental

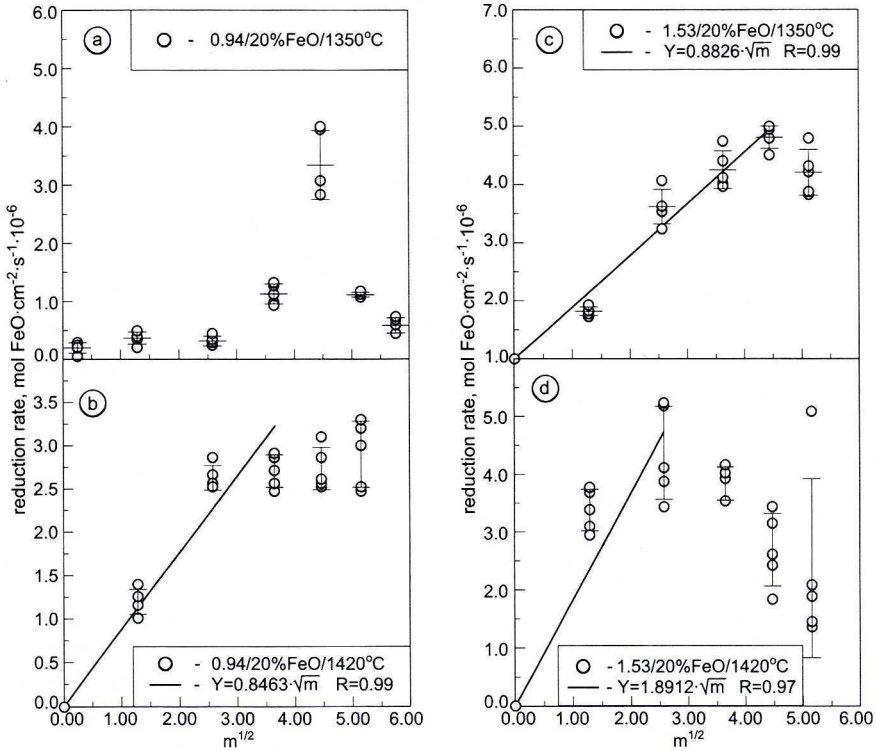

Fig. 5. Reduction rates vs parameter $m^{1/2}$ for given reduction conditions (20% FeO)

TABLE 2

Parameters for calculation of diffusion coefficient, D , and the thicknesses of diffusional boundary layer, δ , for the reaction of reduction of FeO from the slag with a basicity of 0.94, 1.53 at FeO contents of 20% and at the reduction temperatures 1350°C and 1420°C

Slag basicity CaSiO_2	Disc rotation r.p.m.	1350°C				1420°C			
		$j \cdot 10^6$ $\text{mol FeO} \cdot \text{cm}^{-2} \cdot \text{s}^{-1}$	v cm^2/s	ω rad/s	$c_o \cdot 10^3$ $\text{mol FeO}/\text{cm}^3$	$j \cdot 10^6$ $\text{mol FeO} \cdot \text{cm}^{-2} \cdot \text{s}^{-1}$	v cm^2/s	ω rad/s	$c_o \cdot 10^3$ $\text{mol FeO}/\text{cm}^3$
0.94	100	–	0.817	10.47	8.38	1.09	0.581	10.47	8.32
	400	–	0.817	41.89	8.38	2.18	0.581	41.89	8.32
	800	–	0.817	83.78	8.38	3.09	0.581	83.78	8.32
1.53	100	1.14	0.950	10.47	8.91	2.44	0.583	10.47	9.07
	400	2.28	0.950	41.89	8.91	4.88	0.583	41.89	9.07
	800	3.22	0.950	83.78	8.91	–	0.583	83.78	9.07
	1200	3.94	0.950	125.66	8.91	–	0.583	125.66	9.07

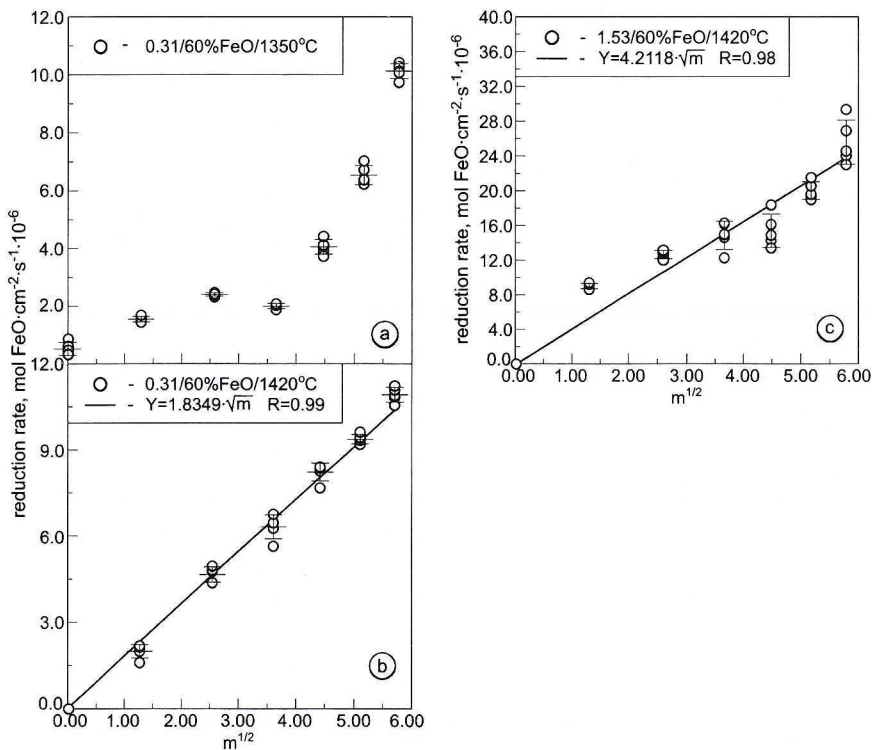

Fig. 6. Reduction rates vs parameter $m^{1/2}$ for given reduction conditions (60% FeO)

burden over to the picture of tendencies to forming these parameters depending on the selected variable parameters of reduction. Therefore, the reduction rate r determined previously for each case of temperature, basicity and disc rotation was taken for the calculations from the regression equations applicable to those cases, shown in Figs. 5 and 6.

The results of calculations of the diffusion coefficient D and the thickness of the limiting diffusion layer δ are summarized in Tables 4 and 5. In addition, the values of D and δ are given for the case of FeO reduction from the slags of basicities of 0.66 and 1.27, the result of which are described in detail in the paper [33].

The analysis of the obtained values of diffusion coefficients, performed in work [32,33], has shown that they can be attributed to the oxide ions O^{2-} .

3.1.3. Evaluation of mass transfer coefficients and the reduction rate in the rotating disc reduction conditions

The calculated diffusion coefficients enable mass transfer coefficients to be determined in the examined reduction conditions from relationship (4) [34]:

$$k_m = 0.176 \cdot \omega^{0.7} \cdot d^{0.4} \cdot \nu^{-0.344} \cdot D^{0.644}, \quad (4)$$

TABLE 3

Parameters for calculation of diffusion coefficient, D , and the thicknesses of diffusional boundary layer, δ , for the reaction of reduction of FeO from the slag with a basicity of 0.31, 1.53 at FeO contents of 60% and at the reduction temperatures 1350°C and 1420°

Slag basicity Ca/SiO ₂	Disc rotation r.p.m.	1350°C				1420°C			
		$j \cdot 10^6$ mol FeO · cm ⁻² · s ⁻¹	ν cm ² /s	ω rad/s	$c_0 \cdot 10^3$ mol FeO/cm ³	$j \cdot 10^6$ mol FeO · cm ⁻² · s ⁻¹	ν cm ² /s	ω rad/s	$c_0 \cdot 10^3$ mol FeO/cm ³
0.31	100	–	0.156	10.47	29.82	2.37	0.118	10.47	29.65
	400	–	0.156	41.89	29.82	4.73	0.118	41.89	29.65
	800	–	0.156	83.78	29.82	6.70	0.118	83.78	29.65
	1200	–	0.156	125.66	29.82	8.20	0.118	125.66	29.65
	1600	–	0.156	167.55	29.82	9.47	0.118	167.55	29.65
	2000	–	0.156	209.44	29.82	10.59	0.118	209.44	29.65
1.53	100	–	–	–	–	5.43	0.152	10.47	29.65
	400	–	–	–	–	10.87	0.152	41.89	29.65
	800	–	–	–	–	15.37	0.152	83.78	29.65
	1200	–	–	–	–	18.83	0.152	125.66	29.65
	1600	–	–	–	–	21.73	0.152	167.55	29.65
	2000	–	–	–	–	24.30	0.152	209.44	29.65

TABLE 4

Diffusion coefficients, D (cm²/s), and the thicknesses of diffusional boundary layer, δ (cm), for the reaction of reduction of FeO from the slag with FeO contents of 20%, determined for the calculated values of r from the regression equations relevant to each case of disc rotations, temperature and basicity

Slag basicity CaO/SiO ₂	Disc rotation r.p.m.	1350°C		1420°C		$\frac{D_{1420}}{D_{1350}}$
		$D \cdot 10^7$	$\delta \cdot 10^3$	$D \cdot 10^7$	$\delta \cdot 10^3$	
0.66 ¹⁾	100	0.76	2.24	1.86	2.84	2.44
	400		1.12		1.42	2.44
	800		0.79		1.00	2.44
	1200		0.65	–	–	–
	1600	–	–	–	–	–
0.94	100	–	–	4.62	3.52	–
	400	–	–		1.76	–
	800	–	–		1.24	–
1.27 ¹⁾	100	6.44	4.16	16.00	5.25	2.48
	400		2.08		2.63	2.48
	800		1.47		1.86	2.48
	1200		1.20		1.52	2.48
	1600		1.04	–	–	–
1.53	100	5.02	3.93	13.60	5.04	2.71
	400		1.96		2.52	2.71
	800		1.39	–	–	–
	1200		1.13	–	–	–

¹⁾ data published in *Metallurgical and Materials Transactions B*, **32B**, 821 (2001)

TABLE 5

Diffusion coefficients, D (cm^2/s), and the thicknesses of diffusional boundary layer, δ (cm), for the reaction of reduction of FeO from the slag with FeO contents of 60%, determined for the calculated values of r from the regression equations relevant to each case of disc rotations, temperature and basicity

Slag basicity CaO/SiO ₂	Disc rotation r.p.m.	1350°C		1420°C		$\frac{D_{1420}}{D_{1350}}$
		$D \cdot 10^7$	$\delta \cdot 10^3$	$D \cdot 10^7$	$\delta \cdot 10^3$	
0.31	100	–	–	1.47	1.84	–
	400	–	–		0.92	–
	800	–	–		0.65	–
	1200	–	–		0.53	–
	1600	–	–		0.46	–
	2000	–	–		0.41	–
1.27 ¹⁾	100	5.34	3.14	12.9	3.80	2.42
	400		1.57		1.90	2.42
	800		1.11		1.34	2.42
	1200		0.91		1.10	2.42
	1600		0.78		0.95	2.42
	2000		0.70		0.85	2.42
1.53	100	–	–	5.45	2.97	–
	400	–	–		1.49	–
	800	–	–		1.05	–
	1200	–	–		0.86	–
	1600	–	–		0.74	–
	2000	–	–		0.66	–

¹⁾ data published in *Metallurgical and Materials Transactions B*, **32B**, 821 (2001)

where:

k_m – mass transfer coefficient, cm/s,
 d – disc diameter, cm.

TABLE 6
 Mass transfer coefficients, k_m (cm/s · 10⁻⁴) calculated from relationship (4) for reduction from the slag with FeO contents of 20% and 60% at given disc rotational speeds

% FeO in slag	Temp. °C	Slag basicity CaO/SiO ₂	Disc rotation, r.p.m.					
			100	400	800	1200	1600	2000
20	1350	1.53	1.06	2.81	4.56	6.06	–	–
	1420	0.94	1.19	3.15	5.11	–	–	–
		1.53	2.39	6.30	–	–	–	–
60	1420	0.31	0.99	2.61	4.23	5.62	6.88	8.04
		1.53	2.10	5.55	9.02	12.00	14.07	17.10

Thus determined coefficients k_m are summarized in Table 6. The obtained mass transfer coefficients made it possible to determine the reduction rate and to make the assessment of the degree of consistence with the experimental data. The reduction rate was calculated from the expression:

$$j_{\text{FeO}} = k_m \cdot (c_{\text{oFeO}} - c_{\text{FeO}}^i), \quad (5)$$

where:

j_{FeO} – calculated reduction rate, mole FeO/cm²/s

c_{FeO}^0 – concentration of FeO in the volume of slag, mole FeO/cm³

c_{FeO}^i – concentration of FeO at the reaction interfacial surface, mole FeO/cm³.

Since in the case of reduction proceeding in the region controlled by mass transfer the FeO concentration at the interfacial surface is zero, then equation (5) takes on the form of (6):

$$j_{\text{FeO}} = k_m \cdot c_{\text{oFeO}}. \quad (6)$$

The results of calculations performed using this formula are shown in Tables 7, 8 and in Figures 7 and 8. These diagrams show calculated and experimental reduction rates, respectively, (including also reduction rate result determined from the linear regression equations). In evaluating the degree of agreement of the calculation results with the experimental results, data obtained from the linear regression were used instead of the direct experimental results, as the former are least of all affected by the momentary effects of uncontrolled factors.

TABLE 7

Reduction rates: calculated, experimental, and calculated from regression equations (exp.-regr.) for given reduction conditions: slag – 20% FeO, temp. 1350 and 1420°C, ($\text{mol FeO} \cdot \text{cm}^{-2} \cdot \text{s}^{-1} \cdot 10^{-6}$)

Temp. °C	Slag basicity CaO/SiO ₂	Results	Disc rotation, r.p.m.			
			100	400	800	1200
1350	1.53	exp.	1.82	2.62	3.25	3.81
		exp.-regr.	1.14	2.28	3.22	3.94
		calc.	0.94	2.50	4.06	5.40
1420	0.94	exp.	1.21	2.64	2.72	–
		exp.-regr.	1.09	2.18	3.09	–
		calc.	0.99	2.62	4.25	–
	1.53	exp.	3.40	4.40	–	–
		exp.-regr.	2.44	4.88	–	–
		calc.	2.17	5.71	–	–

TABLE 8

Reduction rates: calculated, experimental, and calculated from regression equations (exp.-regr.) for given reduction conditions: slag – 60% FeO, temp. 1420°C ($\text{mol FeO} \cdot \text{cm}^{-2} \cdot \text{s}^{-1} \cdot 10^{-6}$)

Slag basicity CaO/SiO ₂	Results	Disc rotation, r.p.m.					
		100	400	800	1200	1600	2000
0.31	exp.	2.00	4.67	6.34	8.25	9.40	10.95
	exp.-regr.	2.37	4.73	6.70	8.20	9.47	10.59
	calc.	2.94	7.74	12.54	16.66	20.40	23.84
1.53	exp.	6.04	8.46	9.95	10.31	13.39	17.10
	exp.-regr.	5.43	10.87	15.37	18.83	21.73	24.30
	calc.	6.23	16.45	26.74	35.58	43.58	50.70

Figure 7 shows data for reduction from the 20% FeO slags at the reduction temperatures 1350°C and 1420°C, whereas Figure 8 presents data related to reduction from the 60% FeO slags at the same reduction temperatures.

Very good and good agreement of the experimental results and the calculated results is visible at low disc rotations of 100 and 400 rpm (with a difference of several and above ten percent, respectively). With increasing disc rotational speed the gap between

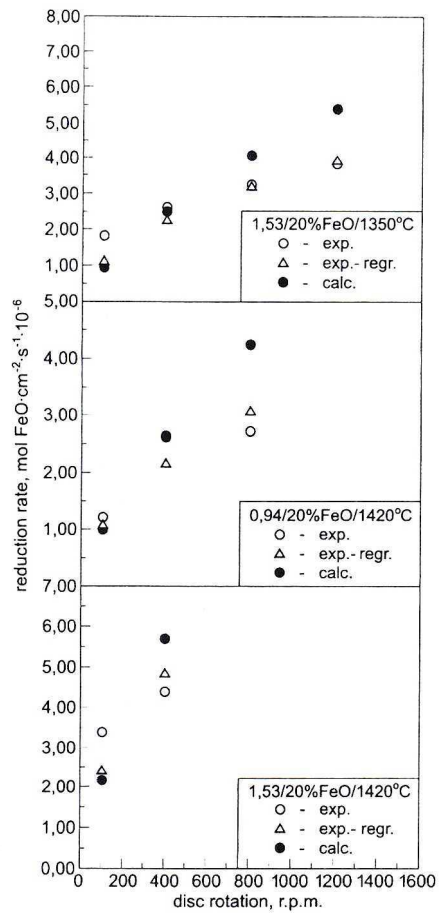

Fig. 7. Reduction rates (experimental, calculated, exp-regression) vs disc rotation for given reduction conditions (20% FeO, temp. 1350 and 1420°C)

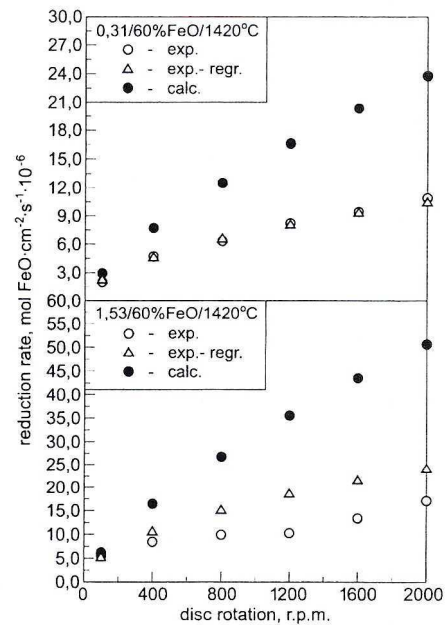

Fig. 8. Reduction rates (experimental, calculated, exp-regression) vs disc rotation for given reduction conditions (60% FeO and 1420°C)

the calculated and experimental rates grows. Presumably, change of the kinetic reduction control factor takes place with the increase of disc rotational speed. Boudouard's reaction of carbon gasification [32,35] and excessive "shielding" of the graphite surface from the liquid slag by the increasing amount of gaseous reduction products may have a significant contribution to this change. This would mean that the transfer of the reagents in the gaseous phase occurring between the reducer surface and the liquid slag should also be considered when determining mass transfer coefficients.

4. Statistic evaluation of the repeatability of experimental reduction results

The results of the reduction of iron oxides in the liquid phase indicate – as seen in Figure 4 – that the momentary reduction rates undergo some fluctuations which are quite distinct in many variants. This causes the evaluation of the repeatability of experimental results to become important, while appropriate methods for making the evaluation of these phenomena are the methods of mathematical statistics.

The sets of statistical data, in the case of the studies conducted on reduction, are the reduction rate results obtained from repeated experiments (exp. 1, exp. 2) and summarized in Table 9. Subject to statistical evaluation are all variants of reduction from the slag of 20% FeO content, which have been a basis for the calculation of the diffusion coefficients, D , and the thickness of the limiting diffusion layer, δ (including data for FeO reduction from slag of basicity 0.66). As can be seen from the tabulated data, five reduction rate measurements correspond to each disc rotational speed. As has already been mentioned earlier, of twelve reduction rate data for each 120-second time interval (corresponding to a specified disc rotational speed), the last seven measurements were taken into account to avoid any possible effect of the reduction conditions from the previous interval. Of these seven data two (the maximum and the minimum) values were rejected, and the remaining five values were treated as data for statistical evaluation.

For the evaluation of the repeatability of experimental results, one of the options of the StatSoft computer program, serving for the verification of hypotheses, was used. At the zero hypothesis with the following inequality of the mean values of μ_1 and μ_2 :

$$H_0: \mu_1 = \mu_2 \quad (7)$$

a criterion for the repeatability of the results of two independent experiments is the relation $p > \alpha$ (where p denotes the probability of making the error of rejecting the hypothesis of the lack of a difference between the mean values, while α denotes the level of significance of the test). At the given level of significance $\alpha = 0.05$, the satisfied condition $p > 0.05$ means that there are no grounds for rejecting the hypothesis H_0 of the equality of the mean values on two examined categories of the general population, with the probability of making an error being one per twenty cases.

TABLE 9
Reduction rate of FeO (mol FeO·cm²·s⁻¹·10⁻⁶) from slags of given basicities, (20% FeO) at temperatures 1350°C and 1420°C

Disc rotation r.p.m.	1350°C				1420°C					
	Slag basicity, CaO/SiO ₂									
	0.66		1.53		0.66		0.94		1.53	
	exp.1	exp.2	exp.1	exp.2	exp.1	exp.2	exp.1	exp.2	exp.1	exp.2
100	0.59	0.49	1.83	0.88	0.83	0.80	1.02	1.31	3.41	2.10
	0.54	0.44	1.78	0.78	0.78	0.86	1.17	1.41	3.80	2.00
	0.49	0.48	1.73	0.88	0.68	0.86	1.17	1.37	3.71	2.97
	0.59	0.34	1.93	1.10	0.63	0.88	1.41	1.56	3.12	2.97
	0.49	0.43	1.83	0.98	0.73	0.83	1.27	1.75	2.97	4.00
100	0.59	0.50	2.24	2.42	0.98	1.17	2.68	3.05	3.90	2.83
	0.44	0.32	2.63	2.62	1.02	1.20	2.88	2.93	4.14	3.12
	0.49	0.34	2.54	3.17	0.93	1.22	2.54	3.29	5.27	2.83
	0.44	0.28	2.63	2.76	0.98	1.14	2.58	3.29	5.22	2.93
	0.63	0.39	3.07	2.81	0.98	1.17	2.54	2.69	3.46	3.17
400	0.78	0.52	3.75	3.74	1.56	1.02	2.49	3.38	–	–
	0.63	0.50	3.12	4.21	1.51	1.27	2.93	3.05	–	–
	0.78	0.48	3.41	4.15	1.56	1.37	2.88	2.81	–	–
	0.73	0.59	2.97	4.15	1.37	1.20	2.58	3.05	–	–
	0.83	0.59	3.02	3.74	1.37	1.27	2.73	2.64	–	–
1200	0.93	0.82	3.80	3.70	1.27	1.57	–	–	–	–
	0.83	0.73	4.00	3.67	1.32	1.64	–	–	–	–
	1.02	0.58	3.80	3.60	1.46	1.64	–	–	–	–
	0.98	0.65	3.95	3.80	1.37	1.37	–	–	–	–
	0.83	0.65	3.51	3.80	1.41	1.55	–	–	–	–

The results of calculations performed using the *StatSoft* program are summarized in Table 10. As can be seen from the values of the parameter p given in the tables, the condition $p > 0.05$ is satisfied for three variants of reduction i. e. for reduction from slags of basicity 1.53 (1350°C) and for slags of basicities 0.66 and 0.94 at 1420°C. Thus, it can be assumed in this case that the examined reduction rates do not differ at the level of significance 0.05. This is not true for the two remaining variants of reduction (i. e. for

reduction from slag of basicity 0.66 at 1350°C and of basicity 1.53 at 1420°C) where, as can be seen from Table 10, the condition $p > 0.05$ is not satisfied.

TABLE 10
Results of the t test for the difference of average values for independent experiments of FeO reduction from liquid slags (20% FeO), at temperature 1350°C and given slag basicities

Temp. °C	Basicity	Average value		Test parameters			Standard dev.	
		exp.1	exp.2	t	df	p	exp.1	exp.2
1350	0.66	0.68	0.51	3.410	38	0.002	0.182	0.141
	1.53	2.88	2.85	0.088	38	0.930	0.793	1.247
1420	0.66	1.14	1.20	-0.697	38	0.490	0.314	0.270
	0.94	2.19	2.50	-1.132	28	0.267	0.736	0.783
	1.53	3.90	2.89	3.293	18	0.004	0.791	0.558

The applied *StatSoft* computer program does not provide, however, the capability of evaluating the differences in the mean values at other levels of significance, α , e.g. 0.01 or 0.001, which would represent an important piece of information in relation to the variants that does not satisfy the condition $p > 0.05$ at the level of significance $\alpha = 0.05$. This capability is offered by the "traditional" test t for the statistical evaluation of experimental results repeatability (the test t for the difference between two mean values) as given in work [36]. This test was employed not only for the evaluation of the consistence of the results of those variants that does not satisfied the condition $p > 0.05$, but also (as verification) for the whole of results shown in Tables 10. The expression for t for the verification of the difference between two mean values has the following form:

$$t = \frac{|\bar{x}_1 - \bar{x}_2|}{\bar{s}(x) \sqrt{1/n_1 + 1/n_2}} \quad (8)$$

where:

\bar{x}_1 i \bar{x}_2 – two separate mean values,

n_1 i n_2 – sizes of samples, of which x_1 and x_2 , respectively, have been calculated,

$\bar{s}(x)$ – total estimation of the standard deviation of both sets of data.

The total estimation of the standard deviation $s(x)$ is calculated from the following equation:

$$\bar{s}(x) = \sqrt{\frac{\Sigma'x_1^2 + \Sigma'x_2^2}{n_1 + n_2 - 2}}, \quad (9)$$

where:

$\Sigma'x_1^2$ i $\Sigma'x_2^2$ denote the sum of squares of deviations from the mean values for the first and the second sets of data, respectively.

As the zero hypothesis it is assumed that the two mean values are equal to each other, i.e.:

$$H_0: \mu_1 = \mu_2.$$

The value of t calculated from Equation (8) is compared with the tabulated values for the distribution t with the number of degrees of freedom equal to $n_1 + n_2 - 2$. If the calculated t is greater than the t from the table at the arbitrarily assumed level of significance, then we determine that the zero hypothesis is false, and the estimation of the mean value of the population based on x_1 differs significantly from the estimation of the mean value of the population based on x_2 with the chance α of making an error. Otherwise, the hypothesis is accepted that there is no significant difference between the mean values of the two experiments.

The values of calculations of the value $t_{\text{calc.}}$ for particular variants are summarized in Table 11 together with the critical values t_{kr} taken at the levels of significance $\alpha = 0.05$; 0.01 and 0.001. The values t_{kr} shown in boldface represent those critical values at which the relation $t_{\text{calc.}} < t_{\text{crit.}}$ occurs, i.e. where the hypothesis of the lack of significant differences between the mean values can be accepted.

TABLE 11
Values of t statistic calculated ($t_{\text{calc.}}$) and critical values ($t_{\text{kr.}}$) for levels of significance $\alpha = 0.05$; 0.01 and 0.001 at given degrees of freedom $n_1 + n_2 - 2$ for reduction experiments from slags of 20% FeO content

t	1350°C		1420°C		
	0.66	1.53	0.66	0.94	1.53
$t_{\text{calc.}}$	3.410	0.088	-0.697	-1.133	3.293
$t_{\text{kr.}(0.05)}$	2.025	2.025	2.048	2.048	2.101
$t_{\text{kr.}(0.01)}$	2.713	-	-	-	2.878
$t_{\text{kr.}(0.001)}$	3.570	-	-	-	3.922
$n_1 + n_2 - 2$	38	38	28	28	18

The above data confirm results (obtained using the *StatSoft* program) that for reduction from slags of basicities of 1.53/1350°C and basicities 0.66 and 0.94 at 1420°C, the condition $t_{\text{calc.}} < t_{\text{crit.}}$ is fulfilled at the level of significance $\alpha = 0.05$. In the case of two remaining variants of reduction, on the other hand, the condition $t_{\text{calc.}} < t_{\text{crit.}}$ is not fulfilled at the level of significance $\alpha = 0.05$, but it is fulfilled at the level $\alpha = 0.001$.

Assuming lower levels of significance for the data of reduction from the 20% FeO slags (i.e. using a greater critical value for the assumed statistics) means, however, increasing the risk of making the error of the II type, i.e. not rejecting the zero hypothesis when it is false. In other words, the lower level of significance of the hypothesis being verified, the greater is the probability of the assumed hypothesis being untrue.

5. Summary

The kinetics of reduction of FeO from liquid CaO-FeO-SiO₂ ternary slags was investigated in this investigations. The employed graphite rotating disc methodology has enabled the definition of the kinetic region of the process, and the calculation of the diffusion coefficients of the oxide ions O²⁻ in the slag and the mass transfer coefficients.

The investigations has found the reaction of reduction of FeO from the CaO-FeO-SiO₂ ternary slag in the temperature range 1350–1420°C to proceed in the region of diffusion control, both at 20% and 60% of FeO in the slag.

The calculated diffusion coefficients of FeO are of the order of 10⁻⁷–10⁻⁶ cm²/s. The lowest value of the coefficient *D* is 0,76 · 10⁻⁷ cm²/s and refers to the reduction of FeO from the acid slag (*B* = 0.66) with an FeO content of 20% FeO at the temperature 1350°C. The highest value of the diffusion coefficient (1,60 · 10⁻⁶ cm²/s) is observed in the case of the slag with a basicity of 1.27 at an FeO content of 60% and at the reduction temperature 1420°C.

Changing the slag basicity from 0.66 to 1.27 causes an increase in the diffusion coefficient by approximately 8.5 times, while increasing the reduction temperature from 1350 to 1420°C results in an increase of the diffusion coefficient by a factor of about 2.5.

Very good and good agreement between the experimental results and the results calculated based on the determined diffusion coefficients has been found at lower disc rotations, i.e. 100 and 400 rpm. With increasing disc rotations and increasing reduction rate, Boudouard's reaction starts playing an increasing role [31,32,35], this most probably being true also for the growing amount of gaseous reaction products.

REFERENCES

- [1] R. J. Fruehan, K. Ito, B. Ozturk, *Steel Research* **3-4**, 129 (1989).
- [2] L. Król, Procesy "Smelting reduction" – metalurgia XXI wieku?, *Mat. Konf. III Conference "Metallurgy of Iron"*, Komorni Lhotka, Republika Czeska, 9–11.12.1993.
- [3] G. J. W. Kor, *Steel Research* **3-4**, 122 (1989).
- [4] D. Neuschütz, T. Hoster, *Steel Research* **3-4**, 113 (1989).
- [5] R. J. Fruehan, *Iron a. Steelmaker* **7**, 25 (1996).
- [6] J. Mróz, C. Kolmasiak, *Hutnik-Wiadomości Hutnicze* **6**, 225 (1998).
- [7] J. Mróz, *Hutnik-Wiadomości Hutnicze* **9**, 354 (1998).
- [8] G. S. Jerszov, E. A. Popova, *Izv. Akad. Nauk SSSR, Metallurgija i Gorn. Dielo* **1**, 32 (1964).
- [9] J. Mróz, *Scandinavian Journal of Metallurgy* **23**, 171 (1994).
- [10] M. W. Davies, G. S. F. Hazeldean, P. N. Smith, *Physical Chemistry of Process Metallurgy*, The Richardson Conference, 1973, Publ. Inst. Min. Metall., 1974.
- [11] R. K. Paramguru, R. K. Galgali, H. S. Ray, *Metall. a. Mat. Trans. B* **28B**, 805 (1997).
- [12] M. Görnerup, A. K. Lahiri, *Ironmaking a. Steelmaking* **5**, 382 (1998).
- [13] M. Sugata, T. Sugijama, S. Kondo, *Trans. ISIJ* **14**, 88 (1974).

- [14] A. Sato, G. Aragane, K. Kamihira, S. Yoshimatsu, *Trans. ISIJ*, **27**, 789 (1987).
- [15] M. Sheikhsab Bafghi, Y. Ito, S. Yamada, M. Sano, *ISIJ Int.* **12**, 1280 (1992).
- [16] V. V. Kondakov, D. I. Ryžonkov, D. M. Golenko, *Izv. Vuz-ov Chernaja Metall.* **4**, 23 (1960).
- [17] F. Tsukihashi, M. Amatatsu, T. Soma, *Tetsu-to-Hagane* **14**, 1880 (1982).
- [18] Y. Sasaki, T. Soma, *Metall. Trans. B* **1**, 189 (1977).
- [19] G. R. Belton, R. J. Fruehan, *Proc. Ethem. T. Turkdogan Symp.*, Iron a. Steel Society, Pittsburgh, PA, 1994, p. 3.
- [20] J-D. Seo, S-H. Kim, *Steel Research* **8**, 307 (1998).
- [21] S. Glasstone, H. Eyring, K. J. Laidler, *The theory of rate process*, London, 1941, Mc Graw-Hill Book Company, s. 95.
- [22] V. G. Levich, *Fiziko-Chimičeskaja Hidrodinamika*, Fizmatgis, Moskva, 1959.
- [23] Yu. V. Pleskov, V. Yu. Filinovskij, *Vraščaiuščiisia diskovyi elektrod*, Izd. Nauka, Moskva, 1972.
- [24] S. O. Ericsson, P. O. Mellberg, *Influence of sulphur on the rate of carbon dissolution in liquid iron*, *Scandinavian Journal of Metallurgy* **10**, 15, (1981).
- [25] A. Sarma, W. Cramb, R. J. Fruehan, *Reduction of FeO in smelting slags by solid carbon: Experimental results*, *Metall. a. Mat. Trans. B* **27B**, 717, (1996).
- [26] G. S. Jerszov, E. A. Popova, *Vosstanovlenije železa i kremnija iz szlakovykh rasplavov ugljerodom*, *Izv. Akad. Nauk SSSR, Metallurgija i Gorn. Dieło* **1**, 32, (1964).
- [27] H. Bala, *British Corrosion Journal* **25**, 34 (1990).
- [28] F-Z. Ji, D. Sichen, S. Seetharaman, *Metall. a. Mat. Trans. B* **28B**, 827 (1997).
- [29] Y. Bottinga, D. F. Weill, *Am. J. Science* **269**, 169 (1970).
- [30] C. K. Mills, B. J. Keene, *Int. Mat. Rev.* **1-2**, 105 (1987).
- [31] J. Mróz, *Steel Research* **1+2**, 27 (2000).
- [32] J. Mróz, *Redukcja tlenków żelaza z ciekłych żużli stałym reduktorem węglowym*, *Prace Naukowe Wydziału Metalurgii i Inżynierii Materiałowej, seria Metalurgia*, nr. 4, Wyd. Wydz. Metalurgii i Inżynierii Materiałowej Politechniki Częstochowskiej, Częstochowa 2000.
- [33] J. Mróz, *Metallurgical and Materials Transactions B*, **32B**, 821 (2001)..
- [34] M. Eisenberg, C.W. Tobias, C. R. Wilke, *Chem. Eng. Progr., Symp. Ser.* **16**, 1 (1955).
- [35] J. Mróz, R. Benesch, R. Budzik, *Reakcja Boudouarda w procesie redukcji tlenków żelaza z ciekłych żużli stałym reduktorem węglowym*, IX Konferencja Naukowa "Iron and Steelmaking", Malenovice, Republika Czeska **22-24**, 09. 1999.
- [36] W. Volk, *Statystyka stosowana dla inżynierów*, Wyd. Naukowo-Techniczne, Warszawa, 1973.

REVIEWED BY: MARIAN KUCHARSKI

Received: 8 September 2001.