

Enhancement security and camouflage for free-space optical communication system reliance on switching between structured light beams

Kamal H. Kadem*, Mohammed F. Mohammed

Department of Laser and Optoelectronics, Collage of Engineering, Al-Nahrain University, Jadriyah, Baghdad, Iraq

Article info

Article history:

Received 03 Oct. 2024

Accepted 31 Oct. 2024

Available on-line 05 Dec. 2024

Keywords:

FSO communication;
structured light beams;
security;
beam shaping;
weather disturbances.

Abstract

This novel study uses structured light beams to enhance security and camouflage in free-space optical (FSO) communication systems. The system employs Bessel, Airy, and Vortex beams due to their properties, such as their unique shapes, adaptability to changing environmental conditions, and spread over long distances while keeping data portable. The structured light beams are dynamically switched during transmission to integrity and security over varying propagation distances and atmospheric conditions. In weak and moderate weather conditions, all three structured light beams can propagate up to 5 km while preserving data integrity. However, under stronger turbulence, the Bessel and Vortex beams can extend beyond 3 km, whereas the Airy beam is limited to a maximum distance of 2 km. The system multi-layered security approach includes beam shaping and selective switching between structured light beams to provide camouflage and enhance data protection, ensuring secure and reliable optical communication even in challenging environments. Simulations using the OptiSystem 18 program demonstrate the system robustness and effectiveness in a high-speed FSO communication.

1. Introduction

The free-space optical (FSO) communication is one of the communications technologies that uses light propagating in free space to transmit data. 'Free space' means air, outer space, vacuum, etc. This contrasts with using solids such as optical fibre cable or optical transmission lines [1]. The FSO communication system is one of the prominent wireless communication systems that witnessed a massively increasing interest and vast development in the last decade. Other terms for FSO technology include wireless optical communications (WOC) which is a broader category encompassing FSO, and fibreless communication, highlighting the absence of fibre optics. Lasercom is another common term, specifically referring to systems that use lasers for high-speed data transmission in free space. The most widely recognized term is optical line-of-sight (LOS) communication which describes systems that require a clear, unobstructed path between the transmitter and

receiver. These various terms for FSO indicate that this type of optical connection supports broadband services and is also a practical solution for delivering service to end users, particularly in point-to-point connections in free space between the transmitter and receiver. Compared to fibre optic transmission, FSO technologies function on fundamentally similar principles [2]. The most important features of FSO communication systems are very high speed, low cost, high bandwidth, quick and easy installation, high security, and a license-free long-range spectrum [3]. As FSO communication becomes increasingly important in many applications, the security requirements also become more demanding. Although the high directionality of the optical beam makes FSO communication inherently more secure than RF counterparts, FSO communication can still suffer from optical tapping risks which is an example of weaknesses of these systems in terms of protection: when the main lobe of the optical beam footprint is considerably wider than the receiver size. Therefore, secure communication over FSO links remains challenging [4].

*Corresponding author at: st.kamal.hussein.phd@ced.nahrainuniv.edu.iq

Therefore, in addition to the primary protection LOS provides in FSO communications, one must implement additional protection methods to transmit data confidentially and securely. There are many security methods in FSO communication systems, the essential ones of which are optical encryption [5], quantum key distribution [6], spatial diversity techniques [7], and adaptive optics [8].

These security methods represent some of the general approaches available for protecting FSO communications, each with advantages and limitations. In this study, the authors will implement multiple layers of protection. The system inherently relies on LOS communication, which serves as the initial level of security. The authors are enhancing this with beam shaping as an additional layer of protection. Beam shaping, a commonly used method for securing FSO communication, allows the authors to transform a Gaussian beam into another optical beam. The optical beam selected in their study for transforming the Gaussian beam is a structured light beam. The authors chose structured light beams due to several notable advantages, including their unusual and distinctive shapes, which offer protection and camouflage, and their unique properties that help overcome obstacles and mitigate the effects of the free-space channel.

Structured light beams are optical fields with specially tailored spatial or spatiotemporal structures. These beams have distinct amplitude, phase, or polarization distributions, which can be manipulated to serve various applications such as optical communications, sensing, micromanipulation, and imaging. Examples of structured light beams include Bessel, Airy, Mathieu, Vortex, Hermite, and Vector beams. They differ from conventional Gaussian beams due to their complex spatial characteristics which make them highly versatile in advanced technologies [9]. Due to these beams distinctive shapes and structures, they naturally provide a degree of camouflage for the transmitted optical beam. Different types of structured light beams share similar characteristics, while others have unique features specific to a particular type. This difference in shape and characteristics makes certain structured light beam types more suitable and effective in redistributing for specific applications than others. The beam shape is defined by the intensity distribution and the shaped beam phase is a major factor in determining propagation properties of the beam profile [10]. The process of beam shaping on a Gaussian beam and converting it to a structured light beam can be done in several ways, but it is generally classified into discrete devices such as spatial light modulators (SLM), fibre-based devices, and integrated devices [9].

In this study, the authors will use the SLM technology to generate structured light beams, that is because of its advantages such as flexibility, ease of use, and capability to generate various types of structured light beams. Specifically, SLM technology will transform a Gaussian beam into three well-established and widely-used types of structured light beams: Bessel, Airy, and Vortex. These structured light beams were selected for their unique characteristics, with each belonging to a different beam family, offering distinct advantages. The Bessel beam, often considered the ideal non-diffracting beam, possesses most of the desired properties of non-diffracting beams. However, the Vortex beam, known for its simplicity, is particularly notable for

its distinct orbital angular momentum (OAM) properties. On the other hand, the Airy beam is chosen for its self-acceleration and bending properties, which sets it apart from other non-diffracting beams.

After implementing multiple layers of protection, such as LOS, beam shaping, and the unique characteristics of structured light beams, an additional layer of security is proposed. This new method involves designing the transmission and receiver system to switch precisely between structured light beams during transmission. The authors refer to this technique as an adaptive beam selection where structured light beams are periodically switched based on a pre-established agreement between the sender and receiver. This approach further enhances protection and helps mitigate the effects of interference and attenuation in FSO communications.

Since our new idea combines beam shaping to generate structured light beams with adaptive beam selection technology, the authors found only a limited number of references consistent with their concept of beam shaping with the adaptive beam selection, which was used for comparison. One of the ways used for atmospheric turbulence mitigation in FSO communication focuses on OAM mode selection and space-time coding. This approach leverages the diversity of OAM modes to enhance system resilience under turbulence. Space-time coding adds redundancy, improving the reliability of data transmission despite atmospheric disturbances. The weaknesses of this method are the complexity of the OAM mode generation and detection, as well as space-time coding which may introduce overhead, slightly reducing data rates [11]. The authors' method overcomes the weaknesses of the previous approach by offering greater flexibility in generating and detecting structured light beams, thanks to the use of SLM technology, which is versatile and user-friendly. Additionally, the authors' method maintains a stable data rate, unaffected by atmospheric conditions, due to the inherent properties of structured light beams. These beams resist disturbances and ensure data integrity over long distances, even in varying weather conditions. Another idea is to use OAM array encoding and decoding in FSO communications. This technique increases data capacity by using multiple spatial positions and OAM beams. A significant strength of this method is the increase in encoding capacity with fewer OAM states, making it efficient. However, a major drawback is the complexity involved in generating and detecting large numbers of OAM states which can pose challenges in practical implementation [12]. The authors rely on the same packages, which reduces interference and, thus, reduces the effects of data loss. Most of these types of systems suffer from generating and detecting beams which the authors overcame in their research by relying on the SLM technology in generating and detecting beams. This method is closely aligned with the authors' one, proposing a multi-beam optical switching system for physical layer security in visible light communications (VLC). It uses non-Lambertian beams that dynamically adjust based on real-time channel state information to enhance security. This significantly improves security in situations with limited transmitters. However, it may introduce complexity due to the need for intricate channel state information management and beam-switching mechanisms, which could raise

both system complexity and operational costs [13]. This method is similar to that of the authors in that both rely on knowledge of the channel state to adjust beam transmission accordingly. However, the use of structured light beams sets the authors' approach apart. The choice of these beams because of their unique properties, such as their camouflaged shapes, resistance to dispersion, and their ability to maintain data over long distances, significantly enhances the authors' system performance and security compared to traditional optical beams in traditional methods. The approach the authors propose stands out due to its simplicity and multi-layered protection strategy. It leverages the entire spectrum of three distinct types of structured light beams, allowing for dynamic adjustments and control of structured light beam modes. This flexibility enhances security and adaptability, making it a robust and versatile method.

The proposed system was designed and simulated using the OptiSystem 18 program to assess transmitter and receiver performance over an FSO channel under various weather conditions and different propagation distances. It also involved generating and detecting structured light (Bessel, Airy, and Vortex) beams using MATLAB program version 9.13.

The arrangement of the paper is given as follows: section 2 involves the structured light beam shaping, section 3 details the system model. Section 4 clarifies the security layers in the system model. Section 5 presents the results and discussions. Finally, section 6 provides conclusions.

2. Structured light beam shaping

Light shaping has a long history, from reflective elements, refractive freeform elements, and later computer-generated holograms (CGHs) to diffractive optical elements (DOEs), harnessing interference for light control. More development in this field and recent advances can be attributed to the on-demand rewritable solutions based on liquid crystal spatial light modulators (LC-SLMs), moving beyond display elements to sophisticated light structuring and control devices [14].

The LC-SLM has been widely used in many fields, such as holographic display, precision metering, optical tweezers, lithography, beam shaping, etc. By designing the unit structures shape, size, position, and orientation, LC-SLMs can arbitrarily modulate the optical parameters amplitude, phase, and polarization of the incident light wave. This unique modulation ability with multi-degree of freedom allows for replacing traditional optical elements with bulky structures and single functionality, making the SLMs lightweight, ultrathin, and multifunctional devices [14]. To capitalize on the capabilities and efficiency of the SLM technology for beam shaping, this study used an SLM to convert a Gaussian beam which carries the transmission data into various structured light beam types. By adjusting the input wavefront and generating beams through computer control, SLMs can create diverse structured light beams. The authors chose the common structured light beam types that SLMs can generate, and they depend on them to secure the FSO channel through their distinctive shapes and switching between them periodically. Phase-only SLMs are among the most widely used devices [15].

The authors will focus on and accredit only phase changes to generate and detect structured light beams where phase control is critical, especially for using SLMs as programmable diffractive devices [15].

A structured light beam is a type of beam that maintains its shape and size during propagation, avoiding the typical spread caused by diffraction. Structured light beams are solutions to the Helmholtz equation which governs the propagation of monochromatic light in free space. These beams are characterised by their propagation-invariant transverse intensity profiles. The general equation for straight structured light beams can be derived from the Helmholtz equation and is given by (1) [16]:

$$\nabla^2 E + k^2 E = 0, \quad (1)$$

Where ∇^2 is the Laplacian operator, E represents the electric field of the light wave, and k is the wave number related to the light wavelength. The major features of the structured light beams are their non-diffracting nature, OAM, and flexibility in spatial and temporal control [9]. These features and distinctive beams shapes make them ideal for securing FSO communication systems, offering camouflage, protection, and resistance to weather conditions in free space. Also, this allows the systems to transmit data over longer distances while preserving the integrity.

This study selected three types of structured light beams, each chosen for their unique and distinctive properties. The first one, a Bessel–Gauss beam (BGB), is considered the ideal of a non-diffracting beam, encompassing most of the characteristics typical of the non-diffracting beams family. The second one is a Vortex beam representing the simplest form of OAM beams. Its most important characteristics is an OAM which can serve as a foundation for generating other types of beams and has been widely studied in the literature. The third one is finite-energy Airy beams (FABs) which exhibit unusual and peculiar properties that set them apart from non-diffracting beams, such as bending when propagating. Additionally, each of these structured light beams responds differently to atmospheric conditions, turbulence, and attenuation of the transmission medium, particularly in free space. Therefore, employing them together, transitioning between them, and controlling their properties, as proposed in the authors' research, enhances the effectiveness of the security mechanism they suggest.

2.1. Bessel–Gauss beams (BGBs)

Bessel beams have a transverse intensity profile based on the family of Bessel functions. A zero-order Bessel beam has a transverse intensity profile with a bright central core surrounded by bright concentric rings. Unlike GBs, the transverse intensity profile of a Bessel beam does not spread as the beam propagates over a finite distance. One of the most notable qualities of the Bessel beam is that it can reconstruct obstructions placed in the beam path. This property makes the beam useful for stacking multiple objects along the beam central core [17].

Bessel beams are exact solutions to the free-space Helmholtz wave equation in cylindrical symmetry and are mathematically described by (2) [17]:

$$E(\rho, \varphi, z) = E_0 J_\ell(k_r \rho) \exp[iK_z Z] \exp[i\ell \varphi], \quad (2)$$

where $J_\ell(x)$ are the Bessel functions of order ℓ , while k_r and k_z are the transverse and longitudinal components of the wave vector k , respectively, obeying the relation $|k|^2 = k_r^2 + k_z^2$ and $|k| = k = 2\pi/\lambda$, (λ being the wavelength of the electromagnetic radiation making up the Bessel beam) and ρ , φ , and z are the radial, azimuthal, and longitudinal components, respectively. Figure 1 presents simulated zero-order BGBs generated by a phase-only reflective SLM when illuminated by a GB. Using SLM to create arbitrary superposition of these beams offers significant control over their propagation dynamics. In Fig. 1(a), the intensity profile of the zero-order Bessel beam is shown, while in Fig. 1(b), a corresponding phase is depicted, which is generated based on the hologram seen in Fig. 1(c). The SLM also enables mode control of the Bessel beam, allowing for transitions from zero to higher orders by adjusting the topological charge. In their study, as supported by the literature, the authors focused on the zero-order Bessel beam because it has been proven to outperform higher-order modes in terms of propagation over longer distances and better resistance to atmospheric conditions. The authors' system allows seamless switching between Bessel beam modes, enabling transmission data in zero-order mode with the option to switch to higher-order modes. Theoretically, Bessel beams can extend infinitely, suggesting the beam carries infinite energy which underlines their capacity to maintain intensity over long distances with minimal divergence. However, in practice, these BGBs maintain the diffraction-resistant properties of Bessel beams but with a Gaussian envelope that ensures finite energy.

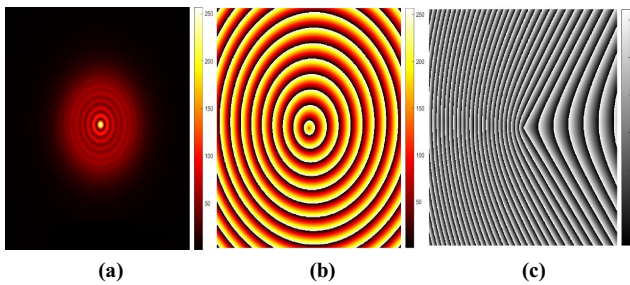

Fig. 1. BGB simulation generated by SLM: (a) intensity profile, (b) phase distribution, (c) hologram.

2.2. Finite-energy Airy beams (FABs)

Airy beams are known for their ability to accelerate and resist diffraction. FABs are practical implementations of ideal Airy beams, where their energy is finite, allowing for real-world applications like FSO communications. The profile appears square waffle-like, with the intensity peaking in one corner and dropping with distance from the peak. While the Airy beam centroid follows a straight trajectory, the peak intensity propagates along a curved path. These curved paths approximately follow the ballistic trajectory of projectiles and exhibit the same “stalling” in motion that gravity produces in launched projectiles. The interference of diffracting beamlets in the Airy beam

waffle-like pattern results in self-healing which is considered one of the distinctive properties of non-diffracting beams [18].

The mathematical expression for ideal infinite-energy Airy beams is done by considering the (1 + 1) D paraxial of diffraction in (3) that governs the propagation dynamics of the electric field envelope associated with planar optical beams [19]:

$$i \frac{\partial \varphi}{\partial \xi} + \frac{1}{2} \frac{\partial^2 \varphi}{\partial s^2} = 0, \quad (3)$$

where $s = x/x_0$ represents a dimension-less transverse coordinate, x_0 is an arbitrary transverse scale, $\xi = z/kx_0^2$ is a normalized propagation distance (concerning the Rayleigh range), and $k = 2\pi n/\lambda_0$ is the wave number of the optical wave. Incidentally, this same equation is also known to govern pulse propagation in dispersive media.

As shown, equation (3) admits the following Airy non-diffracting solution in (4) [19]:

$$\varphi(s, \xi) = Ai \left[s - \left(\frac{\xi}{2} \right)^2 \right] \exp \left(i s \frac{\xi}{2} - \frac{i \xi^3}{12} \right). \quad (4)$$

Clearly, at the origin of $\varphi(s, 0) = Ai(s)$, equation (4) shows that the intensity profile of this wave remains invariant during propagation while it experiences constant transverse acceleration. The term $(\xi/2)^2$ in (4) describes this ballistic trajectory [19]. One of the reasons mentioned in the literature that led the authors to choose Airy beams to be used in their study, is that they exhibit self-acceleration along a parabolic trajectory while maintaining their wavefront which marks a crucial advancement in the study of steerable light beams. These beams have opened new possibilities for directing light along arbitrary paths, significantly enhancing the flexibility of the FSO channel. These beams can be generated by encoding a hologram onto a phase-only reflective SLM, similar to the process used for creating Bessel beams. Figure 2 illustrates the simulation and experimental setup for generating an intensity profile, phase, and hologram to an Airy beam.

By implementing the theoretical foundation and validating it with experimental evidence, this work does not only confirm the accuracy of simulation models but also enhances the authors' understanding of the physical principles that govern the propagation of the Airy beam. These experimental insights are crucial for advancing optical techniques in secure optical communications applications.

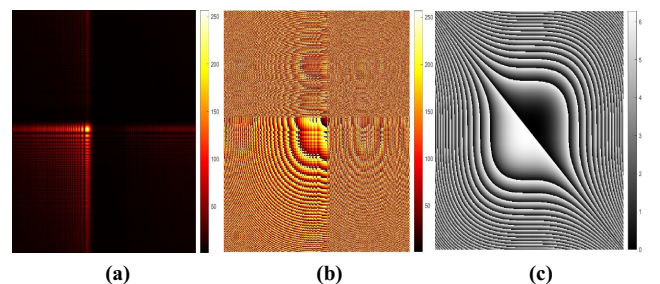

Fig. 2. FAB simulation generated by SLM: (a) intensity profile, (b) phase distribution, (c) hologram.

2.3. Vortex beams (VBs)

Vortices, known as phase singularities or defects in electromagnetic waves, represent a remarkable and intriguing phenomenon in studying light physics. In an optical wave, the phase singularity creates an optical vortex where the wave circulates the core in a specific direction. At the centre of this vortex, the rotational speed becomes infinite, and the light intensity reaches zero. The distinct and resilient characteristics of vortex fields hold great potential for future applications, including optical data storage, distribution, and processing [20]. VB carries OAM due to a helical structure of their wavefront, described by a specific phase function. This results in photons possessing OAM. Neglecting the amplitude function, the desired phase profile can be generated using a spatial light modulator where an azimuthal variation and a blazed grating are encoded to isolate the first-order diffraction from the others [14]. These beams carry a quantized amount of OAM of $l\hbar$ per photon, where l is the topological charge of the vortex (how many twists it has about the axis). The azimuthal phase is undefined at the origin and thus generates a phase singularity along the propagation axis with an associated intensity null. Such fields are also called twisted beams due to their helical phase fronts. Mathematically, such a twisted light beam can be described by (5) [17]:

$$E(\varphi) = E_0 \exp[i l \varphi], \quad (5)$$

where E_0 is the beam amplitude, φ is the azimuth angle, and, in principle, l can take any integer value. SLM can efficiently synthesize the helical modes of the beam and generate novel optical vortices [14]. Exploring the VB propagation in FSO communication has led to gradual enhancements in performance. Additionally, introducing a side lobe-modulated VB technique for FSO communication has significantly boosted data transmission capacity. Moreover, developing multi-singularity-tunable VBs offers the potential for further advancements in communication capacity and speed [21].

The experimental generation of such VBs can be easily accomplished using a hologram in SLM by encoding an azimuthal variation coupled with a blazed grating to separate any order beam wanted from other orders. This method enables the precise control of the VBs topological charge and the generation of beams with the intensity and phase characteristics desired. In this study, the authors accredit a first-order VB due to its distinctive shape compared to the zero-order beam, which closely resembles a GB. Additionally, the first-order beam is preferred over higher orders, as the literature indicates that increasing the order diminishes the vortex effect. The first-order beam has demonstrated superior performance in terms of propagation and data transfer. Figure 3, as described, focuses on the simulated VB order +1, showcasing the intensity profile, phase distribution, and hologram for this VB. First-order VB beam is characterised by a phase singularity at their centre, leading to a doughnut-shaped intensity distribution. The central dark region, or the optical vortex, is where the intensity is zero due to destructive interference. As the order of the VB increases, the diameter of the central dark region also increases, indicating a higher topological charge and, consequently, a more pronounced phase singularity.

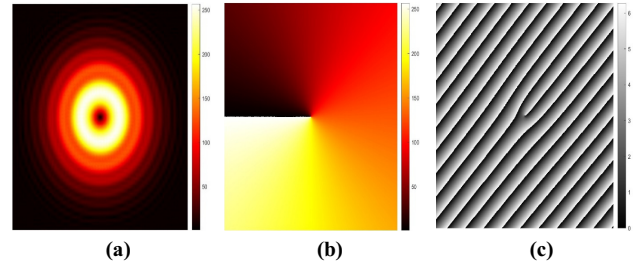

Fig. 3. VB simulation generated by SLM: (a) intensity profile, (b) phase distribution, (c) hologram.

For VBs, the intensity should ideally be zero at the beam centre and maximum at a certain radius from the centre, forming a ring.

2.4. Detection of structured light beams

One of the critical aspects of FSO communication systems is converting structured light beams back into GBs at the receiver. Various methods exist for this conversion and the authors' study focuses on using a hologram in an SLM, considered one of the most effective techniques for detecting packets within the receiving system in FSO communication.

In general, the process of generating light fields can be reversed to "unravel" an incoming light field into its constituent modes through a technique known as modal decomposition. Using an orthonormal basis set, any unknown light field can be expressed as a combination of these basis elements. Since the basis is orthonormal, the expansion coefficients can be determined unambiguously by calculating the inner product between the unknown function and each basis element. Optically, this is achieved by modulating the incoming light with the complex conjugate of the basis function, applying a Fourier transform and analysing the signal at the centre of the Fourier plane to determine the modal amplitude. A similar method can be employed to retrieve the modal phases. With both amplitudes and phases identified, the unknown light field can be reconstructed and compared to the measured one [17]. This method leverages the strengths of SLM technology for phase modulation and beam shaping, making it highly adaptable for FSO communications.

The GB can be numerically calculated in the receiving system after it passes through the SLM by performing a convolution between the Fourier transform of the SLM and the incoming structured light beam received from free space, as described by (6) [22]:

$$\mathcal{G}_{\text{out}} = \mathcal{F}\{E_\ell\} \otimes \mathcal{F}\{t_{\text{SLM}}\}, \quad (6)$$

where \mathcal{G}_{out} represents the field at the output plane, \mathcal{F} is the Fourier transform, \otimes denotes the convolution process and E_ℓ is the incoming structured light beam. In this proposed system, phase-only SLMs were used at both the transmitter and receiver ends of the FSO communication system to generate and detect structured light beams effectively. By employing phase-only modulation, the transmitter precisely shaped the outgoing beam into a structured light profile, ensuring that it maintained its structure and intensity over extended distances despite atmospheric disturbances. Similarly, a phase-only SLM was employed at the receiver

to match and reconstruct the phase profile of the incoming beam. This technique allowed for accurate detection and retrieval of the transmitted data by reinforcing the desired beam pattern while suppressing noise and distortions. Using phase-only SLMs on both ends of the communication link enhanced the system robustness, enabling high-fidelity and efficient data transmission in challenging free-space environments. This dual application of phase-only SLMs demonstrates a streamlined and effective approach to managing and exploiting the advantageous properties of structured light beams in FSO communications, contributing to improved performance and reliability of optical communication systems.

3. System model

FSO communications is a technology that uses light to transmit data through the atmosphere, offering a wireless alternative to fibre-optic cables. FSO communication provides high bandwidth, up to 2.5 Gbps, making it suitable for applications requiring high-data rates, such as communications and military uses. In addition to what was mentioned previously, its advantages include rapid spread, lower costs compared to fibre-optic networks, and immunity to electromagnetic interference. However, FSO communication faces challenges like susceptibility to various weather conditions, weak and strong, beam dispersion, and interference from background light sources, which can limit its effectiveness in long propagation distances [23].

The basic structure of an optical communication system in free space is straightforward, comprising a transmission system, a transmission medium or channel, and a receiving system. The optical transmission system typically converts

the electrical signal containing the data into an optical beam using an optical modulator. This optical beam propagates through free space and is captured by the receiving system, which converts the optical beam back into an electrical signal to retrieve the transmitted data.

The new proposed model for the optical communication system features a transmitter setup that includes three identical SLM devices, each containing a specific hologram to generate a specific structured light beam. Additionally, the system incorporates a pulse generator, line coder, continuous-wave (CW) laser, Mach-Zehnder modulator (MZM), fork device, selector device, optical amplifier, optical power meter, optical spectrum analyser, and spatial visualizer. The pulse generator produces electrical pulses that carry the data which are then modulated into a GB by the MZM. This GB with a 60 dBm power and a wavelength of 1550 nm is generated by a CW laser. The fork duplicates the GB carrying the data into several identical copies, with each copy being directed along a unique path to a specific SLM. Each SLM then generates one of the structured light beams (Bessel, Airy, and Vortex) with the same original data. The optical selection device then allows only one of the structured light beams to pass through, which is subsequently sent to the recipient. The spectrum analyser displays the structured light beam spectra as the output optical beam. Figure 4 compares the spectrum of the GB with the spectra of structured light beams, illustrating the variations in the shape of the structured light beam relative to the GB emitted by the MZM. The spectrum changes after passing through each SLM, with differences observed between them and compared to the MZM-generated spectrum. Moreover, the spectra of the structured light beams align with their respective beam shapes.

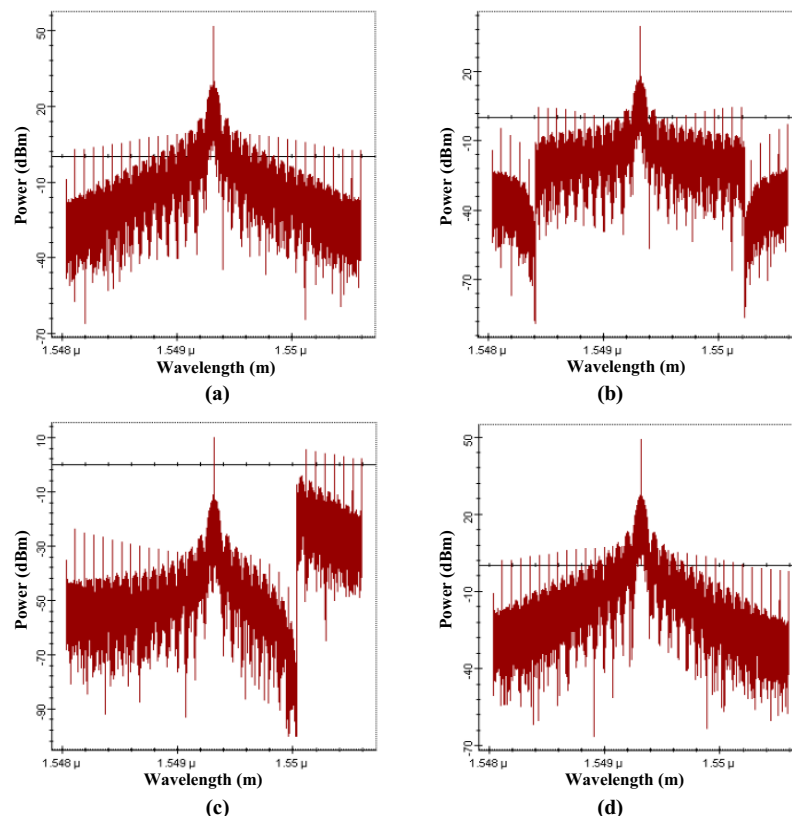

Fig. 4. The optical spectrum for (a) GB, (b) BGB, (c) FAB, and (d) VB.

By using an optical power meter to measure the energy of the structured light beams transmitted and received after propagating through free space, one can accurately determine the distance each beam can travel and assess its performance under varying weather conditions. After measuring the power of all the structured light beams generated by the SLMs, it was observed that each structured light beam experiences different levels of power loss. These variations arise from differences in energy distribution in the SLMs, depending on the type of structured light beam and the generated phase. Additionally, the structured light beams resistance to free-space conditions affects their power differently, leading to varying propagation distances. For that, an optical amplifier was used in the final stage of the transmission system to boost structured light beam strength before transmission. This enhancement helps mitigate atmospheric effects and improves propagation distances, although the propagation distances will still vary depending on the type of structured light beam.

In free space, the structured light beams are scattered, absorbed, and attenuated as a result of turbulences and atmospheric variations. The total attenuation of the structured light beam traveling through the FSO communication link can be calculated as (7) [24]:

$$\alpha = \alpha_{fog_\gamma} + \alpha_{snow_\gamma} + \alpha_{rain_\gamma} + \alpha_{scattering_\gamma}, \text{ dB/km} \quad (7)$$

where α is the attenuation and γ is the operational wavelength in μm . The authors will use a range of attenuation scenarios, from weak to moderate and strong, to evaluate and determine the strength and resilience of structured light beams in free space. The goal is to assess their ability to withstand the transmission medium various effects and maintain the integrity of the data being transmitted over varying distances.

Finally, the structured light beam is received after propagation in free space in the receiving system which consists of an optical amplifier that improves the received signal strength. An optical power meter is used to measure the power of the structured light beam received before it enters the SLM (as some power may be lost due to the SLM) and a fork is used to direct the received structured

light beam to the appropriate reverse SLM. The receiver system also uses three SLMs. These SLMs are programmed with specific phase patterns that match the phase structure of the incoming structured light beams. As the incoming structured light beam passes through the SLM, the phase pattern causes constructive interference if the beam matches the expected structured light profile. If the SLM phase pattern is correct, the structured light beam is refocused to its original form (Gaussian), improving detection. The GB retrieved from the structured light beam is directed to the photodetector to demodulate its electrical signal. The low-pass filter reduces the total environment noise by allowing it to pass only a certain electrical signal frequency.

For more accuracy in analysing the performance of the FSO system, a bit error rate (BER) analyser is used. Where BER can be expressed in terms of the signal-to-noise ratio of the received data signal as (8) [24]:

$$\text{BER} = \frac{2}{\pi \cdot \text{SNR}} \exp\left(\frac{-\text{SNR}}{8}\right). \quad (8)$$

The proposed system was modelled and simulated, as shown in Fig. 5, by using OptiSystem v 18 and MATLAB2022 v 9.13 programs.

4. Security layers in the system model

This study aims to provide multiple layers of security for optical communication systems in free space with low error rates where the initial layer of protection in any FSO communication system is automatically established during its construction of the FSO communication system. It is a LOS that requires the alignment of transmitters and receivers in an optical communication system in free space [25]. This point-to-point configuration requires the attacker to be within LOS to intercept the connection as placing an eavesdropper within this LOS area is difficult. However, if an attacker successfully enters and intercepts the transmission, he may disrupt the path of the optical beam which may cause the optical beam to fail to reach the intended recipient. In this case, the likelihood of the eavesdropper operation being detected by the legitimate recipient is high because the optical beam does not reach

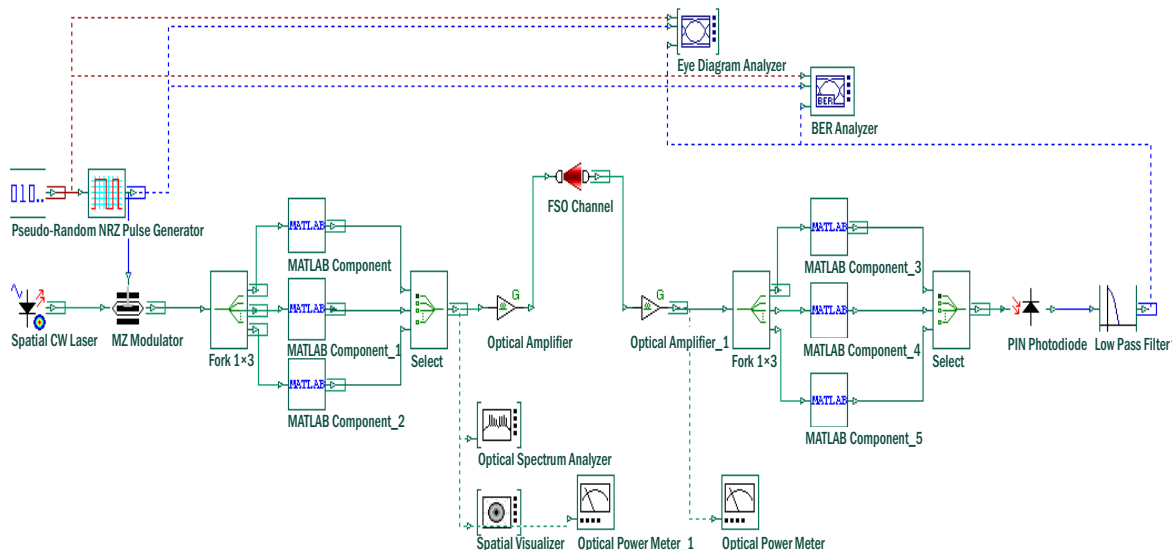

Fig. 5. Schematic view of FSO communication system model design with security.

him, thus revealing the breach. Nevertheless, this security is insufficient due to advancements in hacking techniques which require additional security layers.

The second layer of protection, beam shaping, was applied as the main layer of protection for the proposed system by using SLMs to generate structured light beams with unusual and distinctive shapes. This layer offers two security key benefits: the first is camouflage through the alteration of beam shapes and the second is the use of inverse SLMs at the receiver which act as decoders to restore the original shape of the beam and extract the transmitted data. The choice of structured light beams was thoughtful, as these beams possess unique properties and one can benefit from some of these properties for protection, such as further shape changes during free-space propagation [26], acceleration [27], and course alteration in free space during propagation from transmitter to receiver [28].

Another layer of protection added to this proposed system is based on the system design, which relies on optical forks and selectors in both the transmitter and receiver systems. These components and SLMs help generate structured light beams that carry data and direct and control transmission in free space. The transmitter can switch from one structured light beam to another at any time, while the receiver directs the incoming beam to its SLM to restore it to its original form to extract the transferred data from it. This idea of protection generates several structured light beams, but only one is transmitted at a time, with periodic switching between beams facilitated by an optical selector. This switching between structured light beams can be done but with the necessity of synchronization between sender and receiver in choosing the same SLM device and time.

The FSO communication system the authors propose is distinguished by its simplicity, flexibility, ease of construction, and adaptability to various weather conditions due to the use of multiple types of structured light beams. This allows to select the appropriate beam type for any given situation. Additionally, the system offers multiple layers of protection, ensuring a high level of reliability and making it highly dependable for secure communication under diverse weather conditions.

5. Results and discussions

To evaluate the performance of the proposed FSO communication system and identify the suitable structured light beam (Bessel, Airy, or Vortex) for various weather conditions and propagation distances, the authors calculate key metrics such as maximum Q-factor, signal power, BER, and eye diagram over different propagation distances (short, medium, and long) and various weather conditions (weak, moderate, and strong). This analysis helps determine the optimal structured light beam for each scenario. By gathering extensive channel state information (CSI) and comparing the performance of the structured light beams, one can assess each structured light beam potential and its ability to propagate under specific weather conditions. This enables smooth switching between structured light beams. To facilitate this assessment, three scenarios were studied to identify the appropriate structured light beam based on propagation distance and weather conditions.

5.1. Under weak atmospheric conditions

Under ideal weather conditions, such as clear skies, free space has little to no effect on the propagation of structured light beams, meaning there is no climatic interference. An attenuation value of 2 dB/km was chosen in the simulation of the proposed FSO communication system to represent these ideal conditions.

The literature widely accepts and supports that under weak weather conditions and short propagation distances, the Q-factor and signal power remain stable. However, as the propagation distance increases, these metrics tend to gradually decline, as shown in Fig. 6(a) and (b). In particular, Fig. 6(a) provides a detailed examination of the signal power for the three structured light beams (BGB, FAB, and VB). Although all the structured light beams are generated and transmitted through the same FSO communication system, the power loss varies for each beam as the propagation distance increases. This variation in power loss is due to the type of structured light beam and its ability to resist weather conditions. Despite differences

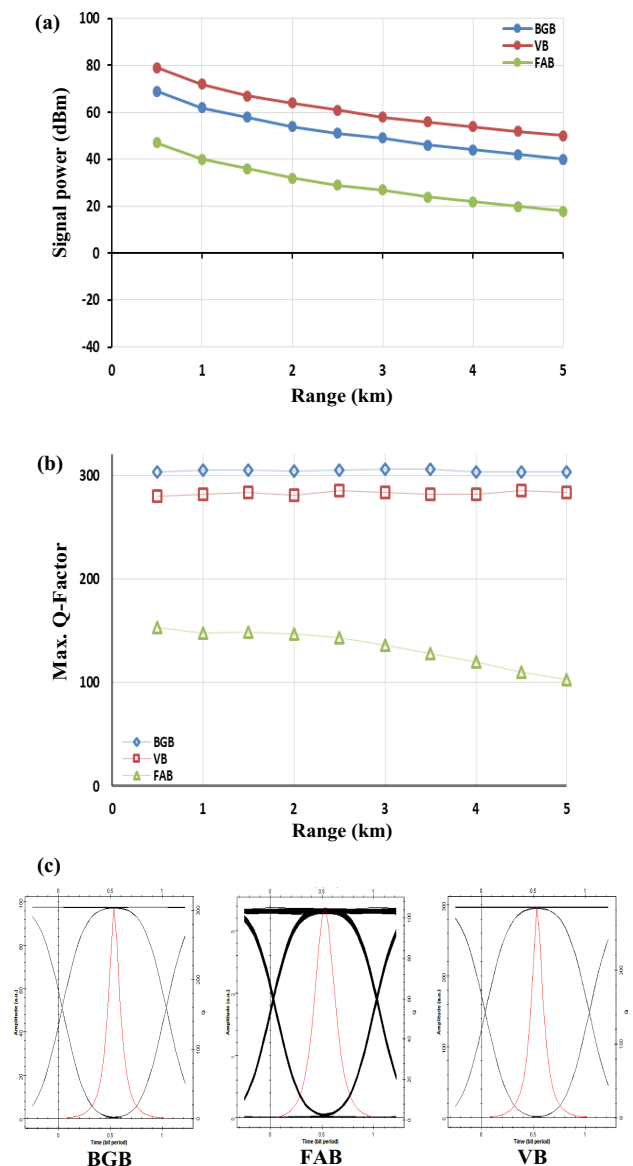

Fig. 6. Comparison of (a) signal power, (b) Q-factor, and (c) eye pattern between structured light beams on attenuation = 2 dB/km.

in weather resistance, all beams exhibit strong resilience in this scenario due to the weak atmospheric turbulence. As a result, the structured light beams (BGB, FAB, and VB) can propagate effectively over distances exceeding 5 km under weak weather conditions.

The Q-factor is a key indicator of an optical beam performance in FSO communication. Generally, the Q-factor decreases as the propagation distance increases due to distortions in the beam shape, particularly the wavefront, after extended propagation. However, structured light beams demonstrate distinct behaviour, especially under weak weather conditions. As illustrated in Fig. 6(b), both BGB and VB maintain a stable and consistent Q-factor even after traveling 5 km. This suggests they preserve beam integrity and continue effectively transmitting data, as further confirmed by the eye diagrams in Fig. 6(c), which reveal clear eye openings for all three structured light beams, indicating minimal degradation and a very low BER.

In Fig. 6, the FAB experiences a gradual decline in Q-factor as the distance increases, with the eye diagram revealing a narrower eye-opening, signalling a higher BER. Despite this decline, the FAB remains effective under weak

atmospheric conditions. This demonstrates that in such environments, all structured light beams generated in the system perform efficiently up to a distance of 5 km, allowing for flexibility in switching between them while maintaining reliable communication quality.

5.2. Under moderate atmospheric conditions

This scenario calculates the signal power, Q-factor, BER, and eye diagrams under moderate weather disturbances. The attenuation values considered are 5 dB/km, representing low fog, and 10 dB/km, representing high fog. Analysing the results at both attenuation values ensures comprehensive verification during moderate weather disturbances.

At a 5 dB/km attenuation, all structured light beams show a power reduction, as shown in Fig. 7(a), but they all continue to propagate and resist weather conditions beyond 5 km. However, when the attenuation increases to 10 dB/km, and atmospheric conditions are still moderate, the power drop becomes more pronounced for structured light beams where the FAB loses power entirely and more at a propagation distance of around 4 km, as it falls below zero.

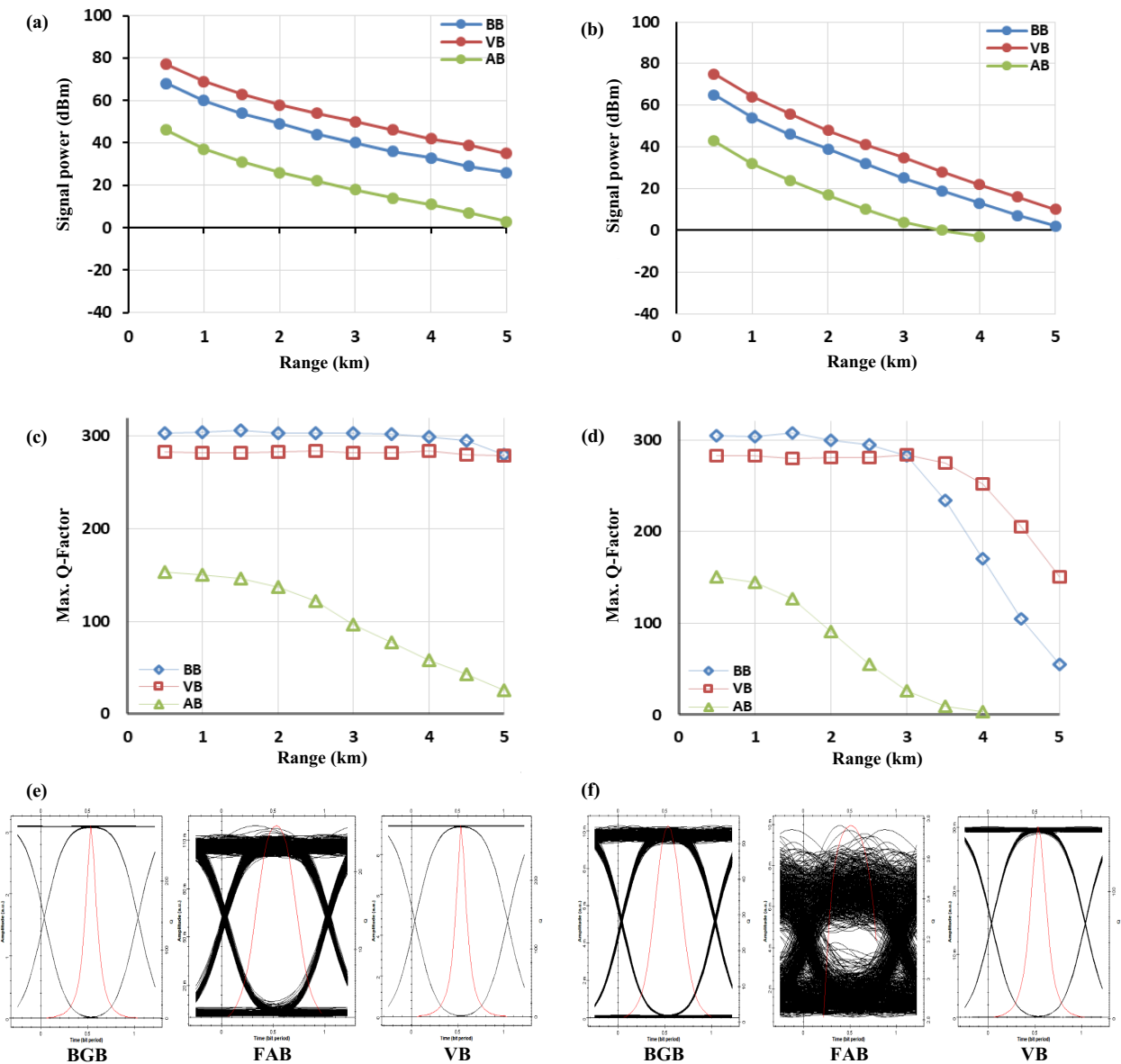

Fig. 7. Comparison of (a), (b) signal power, (c), (d) Q-factor, and (e), (f) eye pattern between structured light beams on attenuation = 5 and 10 dB/km.

In contrast, the BGB loses all its power at 5 km, while the VB continues to effectively maintain power up to 5 km, as seen in Fig. 7(b).

The Q-factor values naturally decrease as atmospheric disturbances intensify and the propagation distance increases. When attenuation is set to 5 dB/km, as illustrated in Fig. 7(c), both the BGB and VB maintain their quality over a distance of 5 km. The FAB also retains its quality but shows a noticeable decline in its quality.

As the attenuation increases to 10 dB/km, reflecting more severe weather conditions, significant changes in structured light beam performance are observed, as seen in Fig. 7(d), where the quality of the BGB declines more rapidly than the VB, though both still manage to propagate effectively up to 5 km. However, the FAB encounters more significant issues, maintaining its performance only up to 4 km.

Regarding the ability of these structured light beams to preserve transmitted data under this weather condition, the authors calculated the BER and examined the eye diagrams at an attenuation of 5 dB/km, as shown in Fig. 7(e). Both BGB and VB exhibit strong performance, characterised by very low BER values and clear, wide-open eye diagrams with minimal noise. This can be attributed to the anti-dispersion properties of the BGB which help it maintain its structure even over long distances. Similarly, VB demonstrates performance on par with BGB, with a comparably low BER and a wide-open eye. In contrast, the FAB shows more noise and a slightly narrower eye than BGB and VB. Therefore, all structured light beams under this influence reach a propagation distance of 5 km while preserving the data carried within it.

At an attenuation of 10 dB/km, both the BGB and VB continue to exhibit increasing distortion as the propagation distance extends, with a maximum range of 5 km. In contrast, the FAB shows a gradual and noticeable narrowing of the eye aperture as the distance increases, signalling a significant rise in BER [Fig. 7(f)]. This effect becomes most pronounced at around 4 km where the eye diagram is nearly closed.

Based on the results of this scenario and their analysis, the authors concluded that under moderate disturbances, all structured light beams perform effectively over a distance of 5 km. However, as disturbances intensify towards the upper range of moderate levels, BGB and VB remain reliable at a propagation distance of 5 km, while the maximum propagation distance for FAB reduces to 4 km.

5.3. Under strong atmospheric conditions

The third scenario involves strong weather disturbances, such as rain and snow, which are simulated by assuming an attenuation value of 20 dB/km. In some cases, these severe conditions can obstruct the propagation of the structured light beam. In Fig. 8(a), which depicts the power of all structured light beams, it can be observed that BGB loses its power after 3 km. VB extends slightly beyond this distance, while the maximum range that FAB can achieve is 2 km.

Figure 8(b) compares the Q-factor of the three structured light beams under extreme weather conditions to evaluate their endurance and propagation distances. Where BGB and VB lose their quality after 3 km, while FAB loses its

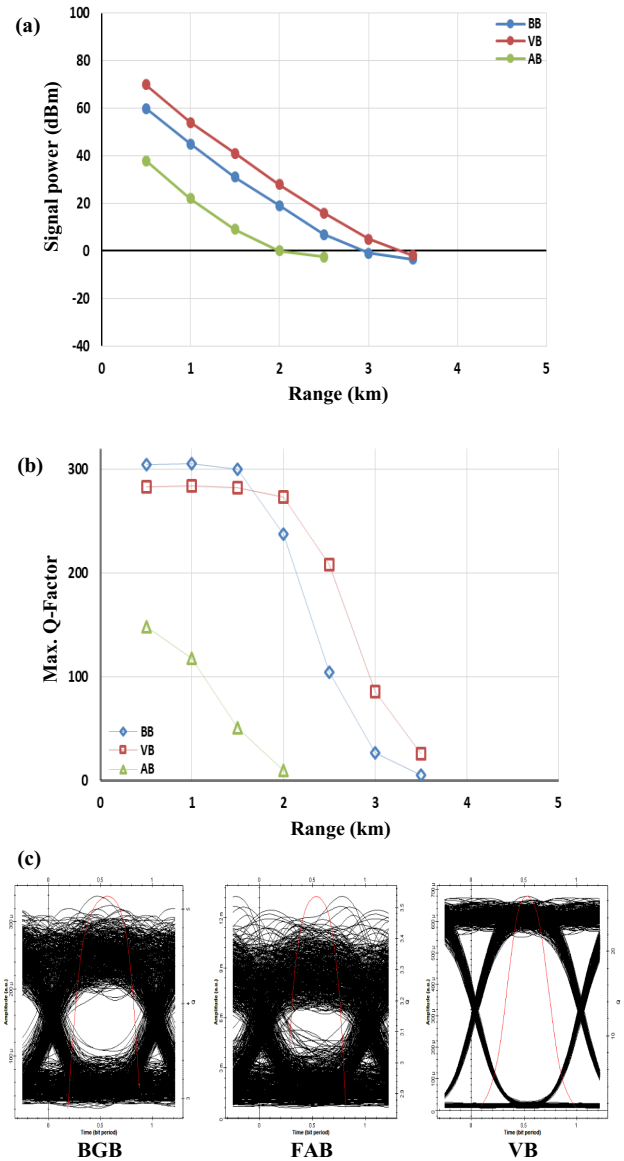

Fig. 8. Comparison of (a) signal power, (b) Q-factor, and (c) eye pattern between structured light beams on attenuation = 20 dB/km.

quality at a propagation distance of 2 km. These results are largely consistent with the results shown in Fig. 8(a).

Figure 8(c) provides clear evidence that the ability of structured light beams to withstand harsh conditions and propagate over long distances is challenging due to the significant noise seen in their eye diagrams. The eye diagram of BGB shows minimal opening, with a high BER at 3 km, indicating that this is the maximum distance BGB can reach before data is lost and distortion occurs. In contrast, VB shows a well-defined eye-opening with a lower BER at 3 km, suggesting it can propagate further. For FAB, the eye is closed, noise levels are extremely high and the BER is elevated at a propagation distance of nearly 2 km, meaning it loses a substantial portion of the transmitted data.

From this scenario, the authors conclude that under strong atmospheric conditions in free space, VB and BGB can propagate for a distance of 3 km at best, while FAB is limited to propagate to 2 km under the same conditions. Thus, the authors' proposed system can use these three camouflage beams and switch between them at a distance

of 2 km. For a propagation distance of 3 km, only two beams, VB and BGB, can be used.

6. Conclusions

This study presents a novel multi-layered security approach to enhance security and camouflage in FSO communication systems by using structured light beams. Bessel, Airy, and Vortex beams were chosen for their unique properties, including resistance to diffraction, OAM, self-healing, and distinct propagation characteristics which make them suitable for secure and reliable data transmission.

The proposed system effectively switches between those structured light beams depending on propagation distance and atmospheric conditions. Under weak and moderate weather conditions, all beams are capable of propagating up to 5 km while maintaining data integrity with some structured light beams having the potential to extend beyond this distance. The Vortex and Bessel beams show strong performance over distances to 3 km, while Airy beams are more suitable in distances to 2 km during strong weather disturbances.

The system effectively uses these structured light beams for camouflage and security by dynamically switching between them depending on the required distance and environmental conditions. This method provides enhanced protection and adaptability, ensuring secure and reliable communication even in challenging atmospheric conditions.

References

- [1] Babani, S., Abdulmalik, Y. S., Abdul'aziz, A., Loko, A. Z. & Gajibo, M. M. Free space optical communication: The main challenges and its possible solution. *Int. J. Sci. Eng. Res.* **5**, 1–8 (2014). <https://www.ijser.org/onlineResearchPaperViewer.aspx?Free-Space-Optical-Communication-The-Main-Challenges-and-Its-Possible-Solution.pdf>
- [2] Al-Gailani, S. A. *et al.* A survey of free space optics (FSO) communication systems, links, and networks. *IEEE Access* **9**, 7353–7368 (2021). <https://doi.org/10.1109/ACCESS.2020.3048049>
- [3] Verma, N. K. & Narayan, H. Analysis of free-space optical system under different atmospheric channels. *Int. Res. J. Eng. Technol.* **4**, 80–83 (2017). <https://www.ijret.net/archives/V4/i7/IRJET-V4I715.pdf>
- [4] Endo, H. *et al.* Free-space optical channel estimation for physical layer security. *Opt. Express* **24**, 8940–8952 (2016). <https://doi.org/10.1364/OE.24.008940>
- [5] Ikeda, K., Sato, Y., Koyama, O. & Yamada, M. Two-dimensional encryption system for secure free-space optical communication of time-series data streams. *Electron. Lett.* **55**, 752–754 (2019). <https://doi.org/10.1049/el.2019.0899>
- [6] Trinh, P. V. *et al.* Design and security analysis of quantum key distribution protocol over free-space optics using the dual-threshold direct-detection receiver. *IEEE Access* **6**, 4159–4175 (2018). <https://doi.org/10.1109/ACCESS.2018.2800291>
- [7] Deng, P., Kane, T., Yuan, X., Wang, M. & Xia, W. Free Space Optical Communication Networks. in *Proc. IARIA SPACOMM 2018: The Tenth International Conference on Advances in Satellite and Space Communications* 340–352 (SPACOMM, 2018).
- [8] Martínez, N., Rodríguez-Ramos, L. F. & Sodnik, Z. Toward the uplink correction: Application of adaptive optics techniques on free-space optical communications through the atmosphere. *Opt. Eng.* **57**, 076106 (2018). <https://doi.org/10.1117/1.OE.57.7.076106>
- [9] Wang, J. & Liang, Y. Generation and detection of structured light: A review. *Front. Phys.* **9**, 688284 (2021). <https://doi.org/10.3389/fphy.2021.688284>
- [10] US Department of Energy. Dickey, F. M., Weichman, L. S. & Shagam, R. N. *Laser Beam Shaping Techniques*. (2000). <https://www.osti.gov/biblio/752659>
- [11] Amhoud, E. M., Trichili, A., Ooi, B. S. & Alouini, M.-S. OAM mode selection and space-time coding for atmospheric turbulence mitigation in FSO communication. *IEEE Access* **7**, 88049–88057 (2019). <https://doi.org/10.1109/ACCESS.2019.2925680>
- [12] Li, S. *et al.* Experimental demonstration of free-space optical communications using orbital angular momentum (OAM) array encoding/decoding. in *CLEO: Science and Innovations JTh2A.67* (Optica Publishing Group, 2015). https://doi.org/10.1364/CLEO_AT.2015.JTh2A.67
- [13] Ding, J., Wang, C. I. J., Yang, H. & Wang, L. Multiple optical beam switching for physical layer security of visible light communications. *IEEE Photonics J.* **14**, 7306209 (2022). <https://doi.org/10.1109/JPHOT.2021.3136233>
- [14] Yang, Y., Cao, L. & Forbes, A. A review of liquid crystal spatial light modulators: devices and applications. *Opto-Electron. Sci.* **2**, 230026 (2023). <https://doi.org/10.29026/oes.2023.230026>
- [15] Li, R. & Cao, L. Progress in phase calibration for liquid crystal spatial light modulators. *Appl. Sci.* **9**, 2012 (2019). <https://doi.org/10.3390/app9102012>
- [16] Andrews, L. C. & Beason, M. *Laser Beam Propagation through Random Media. Second Edition*. (SPIE, 2005). <https://doi.org/10.1117/3.626196>
- [17] Rosales-Guzmán, C. & Forbes, A. *How to Shape Light with Spatial Light Modulators*. (SPIE, 2017). <https://doi.org/10.1117/3.2281295>
- [18] Nelson, W., Palastro, J. P., Davis, C. C. & Sprangle, P. Propagation of Bessel and Airy beams through atmospheric turbulence. *J. Opt. Soc. Am. A* **31**, 603–609 (2014). <https://doi.org/10.1364/JOSAA.31.000603>
- [19] Hu, Y. *et al.* Self-accelerating Airy Beams: Generation, Control, and Applications. in *Nonlinear Photonics and Novel Optical Phenomena* (Eds. Morandotti, R. & Chen, Z.) 1–45 (Springer, 2012). https://doi.org/10.1007/978-1-4614-3538-9_1
- [20] Kivshar, Y. S. & Ostrovskaya, E. A. Optical vortices folding and twisting waves of light. *Opt. Photon. News* **4**, 24–28 (2001). <https://doi.org/10.1364/OPN.12.4.000024>
- [21] Shen, Y. *et al.* Optical vortices 30 years on: OAM manipulation from topological charge to multiple singularities. *Light Sci. Appl.* **8**, 90 (2019). <https://doi.org/10.1038/s41377-019-0194-2>
- [22] Trichili, A. *et al.* Detection of Bessel beams with digital axicons. *Opt. Express* **22**, 17553–17560 (2014). <https://doi.org/10.1364/OE.22.017553>
- [23] Sri, M. S. & Ramana, A. V. Free space optical communication. *Int. J. Mod. Trends Sci. Technol.* **5**, 80–83 (2017). <https://www.ijmtst.com/vol3issue5/290IJMTST030530.pdf>
- [24] Shaina & Gupta, A. Comparative analysis of free space optical communication system for various optical transmission windows under adverse weather conditions. *Procedia Comput. Sci.* **89**, 99–106 (2016). <https://doi.org/10.1016/j.procs.2016.06.014>
- [25] Alkholidi, A. G. & Altowij, K. S. Free Space Optical Communications—Theory and Practices. in *Contemporary Issues in Wireless Communications* (ed. Khatib, M) 160–193 (IntechOpen, 2014). <https://doi.org/10.5772/58884>
- [26] Khonina, S. N., Kazanskiy, N. L., Karpeev, S. V. & Butt, M. A. Bessel beam: significance and applications—a progressive review. *Micromachines* **11**, 997 (2020). <https://doi.org/10.3390/mi11110997>
- [27] Carvalho, M. I. & Facão, M. Propagation of Airy-related beams. *Opt. Express* **18**, 21938–21949 (2010). <https://doi.org/10.1364/OE.18.021938>
- [28] Zhu, L., Wang, A. & Wang, J. Free-space data-carrying bendable light communications. *Sci. Rep.* **9**, 14969 (2019). <https://doi.org/10.1038/s41598-019-51496-z>