

New technique for sharpening ultra-thin wires for the drawing process: incremental furnace stretching

Piotr KUSTRA¹* and Andrij MILENIN¹

AGH University of Krakow, al. Mickiewicza 30, 30-059 Kraków, Poland

Abstract. In the wire drawing process, the wire is subjected to sharpening before each drawing. Traditional methods for sharpening wires involve one of the following techniques: crimping, grinding, rolling, chemical etching, or stretching within a furnace. Wire sharpening becomes especially difficult in the manufacture of ultra-thin wire. This study proposes and examines a novel technique for sharpening thin and ultra-thin wires through specialized stretching in a furnace. This study proposes and investigates a new technique for sharpening thin and ultra-thin wires based on stretching them in the furnace. Using a rheology-based concept of wire deformation during stretching, this study offers a substantial enhancement in the maximum attainable thinning of the wire during sharpening. Technically, this advancement is achieved by transitioning from a single-stage stretching process to an incremental one, characterized by small increments of deformation at each stage. In addition to incremental stretching, the proposed method includes simultaneous movement of the wire through a continuous micro furnace, repeated at each stage of elongation, which achieves thinning of the wire end of a given length. This study theoretically and experimentally explores further potentialities of this approach concerning the fabrication of ultra-thin wire. The findings show that the effectiveness of the proposed method strongly depends on the shape of the stress-strain curve of the wire material. For example, the conducted research demonstrated that this method is more effective for brass than for copper wire.

Keywords: sharpening wire; wire drawing; ultra-thin wires; SEM; FEM.

1. INTRODUCTION

Thin and ultra-thin wires have many applications. They are used in microelectronics, medical applications, micro-soldering, or utilized as piano wires and low-mass gaseous detectors [1–5], among others.

The classical method of wire manufacturing is realized through a cold drawing [6,7] or a hot drawing process [8], which can also be conducted using a heated die [9]. The wire drawing technique can be applied to various materials and diameters in the range of 0.007 to 35 mm [10]. In this technique, the cleaned wire is sharpened, put through a drawing die, and hooked onto a drawing spool. The main problems in the wire drawing process are correct lubrication [11], the wear of the drawing dies [12], and the wire sharpening process.

The wire sharpening process is one of the elements of the wire drawing technology and is conducted before each drawing pass. This process is designed to taper the end of the wire in such a way that it fits through the drawing die. The known methods of wire sharpening include rolling, crimping, grinding, digestion, or stretching in a furnace [13–15]. Machines sharpening the wire by rolling are used to a diameter of approximately 0.8 mm [16]. For wires with a diameter below 0.8 mm, the sharpening process is usually applied by wire stretching in the furnace pkustra@agh.edu.pl. For ultra-thin wires less than 0.05 mm in diameter, this method can also be problematic. Ac-

ording to the drawing practice, the neck that appears when the wire breaks might not be long enough, repeatedly preventing the wire from passing through the drawing die. In addition, such a thin wire is quite flabby. In this case, a greater thinning of the wire means that it does not rub against the walls of the drawing tool hence, and it is easier to put it through the drawing dies. In such cases, the digestion process can be used. It should also be noted that it is difficult to achieve a smooth change in diameter over a long section of the wire using digesting. Unfortunately, the digestion process requires additional tools, with a digestion agent depending on the type of drawing material. In addition, the digesting process can over-etch the grain boundaries of the material, which can result in the brittleness of the wire tip and clogging of the drawing dies. Clearing the die hole with diameters smaller than 0.05 mm is a challenging task. Regardless of the chosen sharpening technique, the wire should be long enough to be easily passed through the drawing die.

In 1969, Weiss and Kot [17] presented a wire production process based on a new drawing method called dieless drawing (DD). The DD method is a stretching of the wire with simultaneous local heating of the deformation zone. This process has several advantages – it allows for elongation of the wire without the use of a drawing die, it lacks friction, and it can be applied to materials with low ductility [18]. Additionally, a considerable strain can be achieved in one DD pass (up to 27% for brass [19], 32% for nickel [20], and 72% for carbon steel [21]). The process can produce materials with different cross-sectional shapes of the workpiece along its length [22,23] and is constantly analyzed and developed by scientists [24,25]. In addition, DD does not require sharpening of the wire before a drawing passes. Unfor-

*e-mail: pkustra@agh.edu.pl

Manuscript submitted 2024-10-08, revised 2024-12-28, initially accepted for publication 2025-01-02, published in March 2025.

tunately, this process also has several disadvantages – instability of the deformation process, which can cause an unstable diameter of the tube [26] or wire along its length or an increase in roughness during the deformation [19, 27].

An extension of the DD method is the incremental dieless drawing (IDD) technique [19]. The idea behind this process is to perform many small increments of strain in each pass of DD [28]. Such an approach slows down the neck formation in the deformed wire and improves the material workability. Since the IDD method allows for large deformations, the authors of this paper propose using it in the wire sharpening process.

The purpose of this paper is to develop an alternative wire sharpening method based on IDD, which is dedicated to thin and ultra-thin wires.

2. MATERIALS AND METHOD

2.1. Materials

The CuZn37 alloy commercial wire and Cu species M1E wire with a diameter of 0.1 mm were used as starting wires. A schematic of the special machine for implementing the tensile test of thin wires for obtaining the stress-strain curve is shown in Fig. 1.

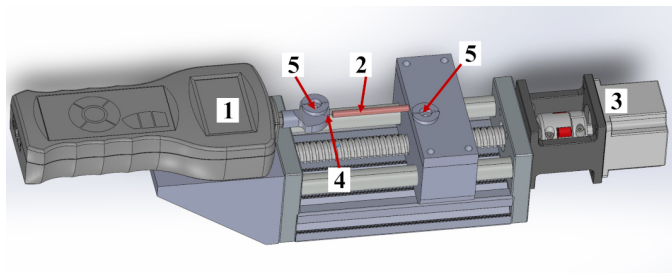

Fig. 1. Schematic of tensile test: 1 – force sensor, 2 – furnace, 3 – stepper motor, 4 – wire, 5 – wire holder

This device allows the implementation of cold and hot tensile tests. A professional force measuring sensor AXIS FB50 5N with an accuracy of 0.001 N was used. The advantage of using such a machine is that the material is directly tested in the form of an ultra-thin wire, which will subsequently be processed. Unlike classical testing methods, which require the production of relatively large samples, in this case, the microstructure of the material being tested ideally matches the microstructure of the material being processed.

2.2. Incremental dieless drawing method

The sharpening technique developed in this work was tested for wires with an initial diameter of 0.1 mm. The following parameters were used: furnace temperature was 380°C for brass and 145°C for copper, and IDD speed of the slow (V_0) and fast (V_1) end of the wire were 15.0 mm/s and 15.7 mm/s, respectively. The area reduction of the wire R in the heated zone can be approximately determined from the volume constancy condition for $V_1 > V_0$

$$R = 1 - \frac{V_0}{V_1}. \quad (1)$$

2.3. Wire sharpening methods

Two methods of wire sharpening are considered in this paper. The first involves the traditional stretching of the wire in a furnace. During stretching at an elevated temperature, the wire undergoes uniform elongation, and then a neck appears, which results in wire breakage. In this way, a sharpened wire is obtained.

The second method of wire sharpening developed as part of this work involves the appropriate use of the IDD process technique. As shown in the paper [19], the IDD technique used during the CuZn37 drawing process allows for achieving more than two times higher longitudinal strain in comparison to the classic DD technique. Consequently, it is possible to obtain a thinner piece of wire, which simplifies and facilitates the process of threading the wire through the drawing die. When using the DD technique in the wire sharpening process, the number of revolutions of the drawing spools should be the same in each drawing pass. This results in a gradual reduction in the wire diameter along the wire as it is shown in Fig. 2.

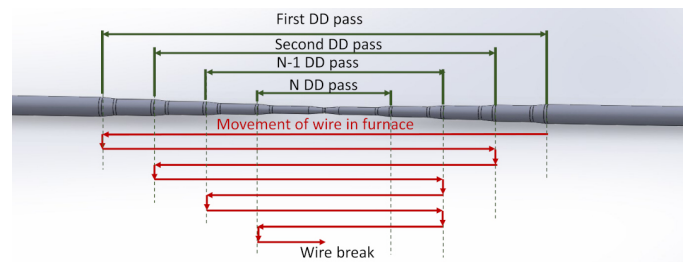

Fig. 2. Scheme of the wire sharpening process using the IDD method

2.4. Ultra-fine wire drawing process using the proposed sharpening process

To illustrate how to implement this concept, we used the simulation of the wire stretching process using QForm v10 FEM (finite element method) software. Since the model is intended for qualitative modelling and explanation of the physical principle of the proposed wire sharpening method, the model was significantly simplified and contains the following assumptions. An axisymmetric rigid-plastic deformation of the wire is assumed when it is stretched; the dimensions of the simulated wire fragment are 0.1 mm in diameter and 1.6 mm in length. A rigid fastening is specified at the lower end of the wire, the upper end moves at a speed of 1.0 mm/s (Fig. 3).

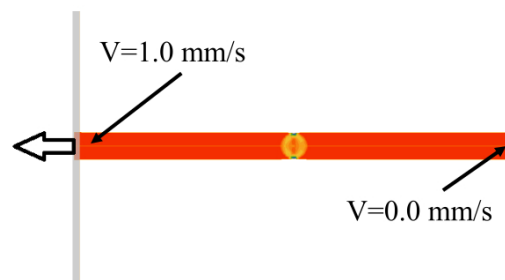

Fig. 3. Calculated scheme of FEM simulation for tensile testing of wire with a diameter of 0.1 mm and a length of 1.6 mm

The number of finite elements during the calculation process varies from approximately 1600 to 2700 due to the adaptation and restructuring of the mesh during deformation. Mesh adaptation proportional to the achieved deformation was used. The influence of strain rate, stress relaxation, and temperature distribution in the sample was not considered during the FEM simulation of the tensile test. Maintaining a constant temperature and strain rate during a tensile test ensures that changes in material behaviour are caused only by the force, and not by other process parameters.

2.5. Ultra-fine wire drawing process using the proposed sharpening process

The CuZn37 and Cu wires with a diameter of 0.1 mm were used as input materials. The wire drawing process was carried out in 18 passes according to the schedule presented in Table 1. A solution of soap in water was used as a lubricant. The wire drawing speed was 15.0 mm/s, the drawing angle was 6°, and elongation per pass was equal to 20%. A schematic of the machines presented in Fig. 4 was used for the wire drawing and new sharpening process. The new sharpening method was used before each pass.

Table 1
Drawing schedule

Draft no	1	2	3	4	5	6
ϕ , mm	0.0965	0.0880	0.0804	0.0734	0.0670	0.0611
Draft no	7	8	9	10	11	12
ϕ , mm	0.0558	0.0510	0.0465	0.0425	0.0388	0.0354
Draft no	13	14	15	16	17	18
ϕ , mm	0.0323	0.0295	0.0269	0.0246	0.0224	0.0205

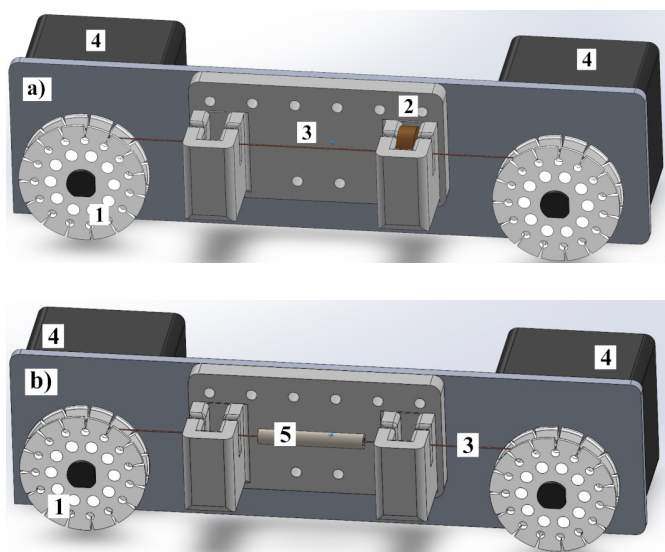

Fig. 4. Schematic of the machine for (a) drawing process and (b) sharpening process: 1 – uncoiler, 2 – drawing die, 3 – drawn wire, 4 – stepper motors, 5 – furnace

2.6. Wire diameter measurement

Due to the small diameters of the analyzed wire (less than 20 micrometres), a scanning electron microscope (SEM) was used to analyze the thickness and shape of the wire neck after wire breakage. The FEI-Inspect S50 microscope was used in the study. The images were obtained using an Everhart-Thornley Detector, with the following settings: accelerating voltage (HV) of 15 kV, magnification of 400 \times , and spot size of 5.0 μ m.

3. RESULTS AND DISCUSSION

3.1. Tensile tests and concept of new technique for sharpening ultra-thin wires

During the tensile test, the movement of the machine traverse (Fig. 1) was constant and equal to 0.1 mm/s. Tests were performed for Cu in the temperature range of 20 to 240°C and CuZn37 in the temperature range of 20 to 600°C. A K-type thermocouple was used to measure the temperature in the heating device (Fig. 1, position 2). At least three samples were used for each tensile test condition. An example of stress-strain curves with the standard deviation is shown in Fig. 5. The experimental result was approximated by the least-squares method to deter-

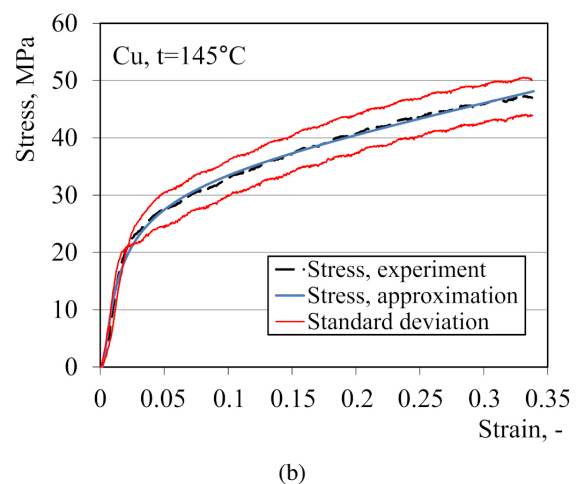
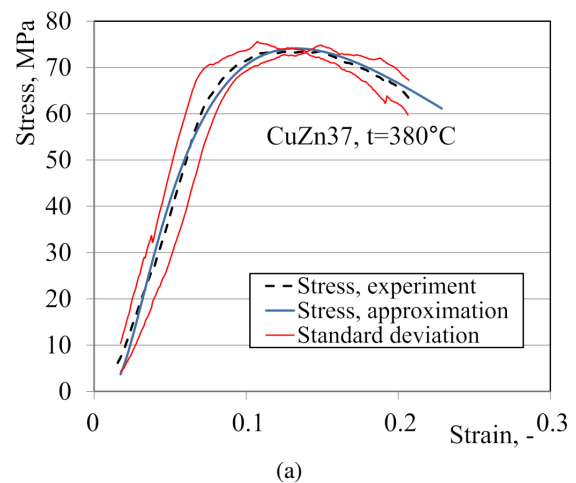
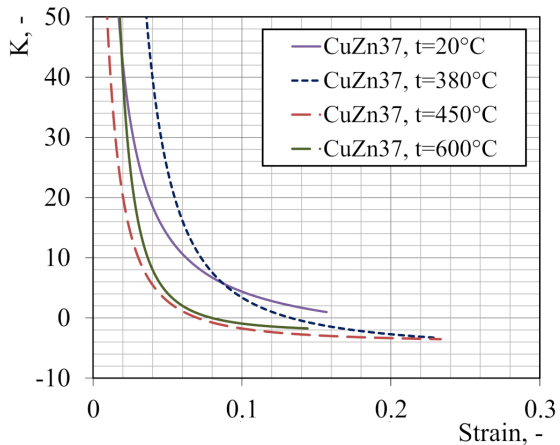

Fig. 5. The flow stress of the initial wire with a diameter of 0.1 mm: (a) CuZn37 alloy, (b) Cu

mine the stress-strain model and plastic strain stability factor K (Fig. 6). This parameter is based on Considère criterion [29] and was used by Wright and Wright [30] for the estimation of plastic deformation stability in the DD process. This parameter was also used by Bylya [31, 32] in complex stress-strain state deformation in the following form

$$K = \frac{d\sigma}{d\varepsilon} \frac{1}{\sigma}, \quad (2)$$

where σ is the flow stress and ε is the effective strain.



(a)

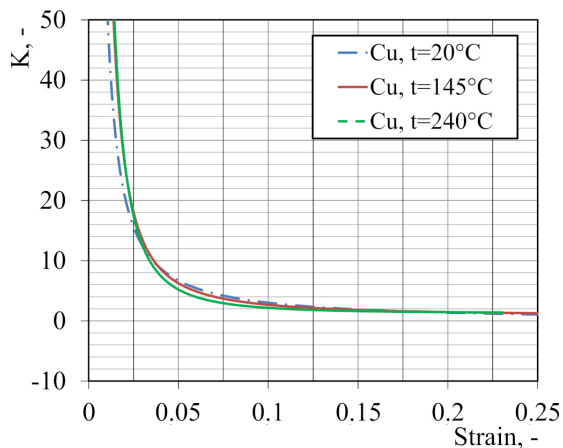

(b)

Fig. 6. Dependence of the K parameter on the temperature of the initial wire with a diameter of 0.1 mm: (a) CuZn37 alloy, (b) Cu

This parameter allows for the quantitative characterization of material softening to predict deformation localization during hot metal forming. For linear stretching, it was theoretically shown that $K < 1$ corresponded to the condition where plastic deformation becomes unstable. In other scenarios, such as the dieless drawing process, the critical value of K must be determined empirically. It is important to note that the onset of unstable deformation does not immediately result in deformation localization and fracture; the process can continue under unstable deformation conditions for a period of time. For instance, Slomchak *et al.* [33] demonstrated that noticeable deformation

localization during the initial phase of rolling occurs at negative values of K .

In the dieless drawing process, cooling of the material after it exits the heating zone further stabilizes the process. This stabilization occurs because the initiated strain instability is mitigated by the increased flow stress resulting from cooling. Consequently, the dieless drawing process is generally more stable than simple stretching at a uniformly distributed temperature within the sample. In [34], it is shown that $K = 0$ can be considered an approximate critical value of K for dieless drawing.

In our study, the parameter K will be used for a comparative analysis of various methods of sharpening the wire by stretching it in different ways and materials. For this reason, the exact critical value of K is not significant.

The change in the value of K depending on temperature and the magnitude of deformation was calculated using equation (2) based on experimental tensile curves. The results are shown in Fig. 6. As can be seen from the results presented in Fig. 6a in the case of CuZn37, the greatest stability of deformation can be obtained at a temperature of the order of 380°C (the highest K -value and the highest longitudinal strain). For copper, regardless of temperature, the K value is practically the same. Tensile tests were not performed for higher temperatures because, as the research [34] shows, the value of the K factor in higher temperatures is very unstable, and, therefore, copper as a material is moderately suitable for the DD deformation process. Plastometric data for copper show that the maximum strain for copper is 0.34 (34%) and 0.23 (23%) for temperatures of 145°C and 240°C, respectively. Therefore, temperatures of 380°C for CuZn37 and 145°C for copper were chosen for the sharpening process. It is for these temperatures that the stress-strain dependencies are shown in Fig. 5.

Based on the above data, we can propose a new concept for sharpening wire, based on stretching it at elevated temperatures. The basis of this concept is the principle according to which stretching should be carried out at the highest possible values of the parameter K , which will lead to inhibition of the process of early neck formation and, as a consequence, an increase in the overall elongation and thinning of the wire fragment intended for sharpening. Numerical analysis of two variants of the sharpening process was performed for the material shown in Fig. 5. The simulation results are presented in Figs. 7–10. The

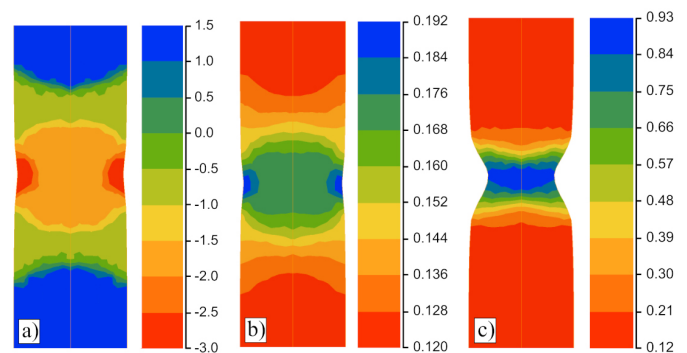

Fig. 7. Distribution of K (a) and effective strain (b, c) during the tension test of CuZn37 wire at 200 ms (a, b) and 226 ms (c)

first two calculations were modelling the continuous stretching of the wire until the beginning of intensive necking for the two materials under study (Figs. 7 and 8). The simulation results showed that when CuZn37 wire is stretched, a neck appears after 226 ms of stretching, which at a stretching rate of 1 mm/s is 0.226 mm of total elongation. The amount of wire deformation in areas outside the neck, which directly affects the diameter of the sharpened wire, was 0.12 (12%) (Fig. 7c). The K value at the time point of 200 ms, preceding the beginning of intensive neck growth, changed unevenly in the wire within the range from -3.0 to 1.5 (Fig. 7a).

A similar calculation for copper wire (Fig. 8) showed that at the same stage of deformation (at 200 ms) the K values are significantly higher than in CuZn37 wire and range from 2.0 to 3.0 . In this case, the deformation of the wire outside the necking zone is 0.13 (13%), that is, higher than for CuZn37 wire. Greater stability of deformation in copper wire leads to inhibition of neck development and the beginning of its formation occurs at the moment of stretching of 400 ms (Fig. 8c, d). A significant development of strain localization in the neck is observed at 430 ms (Fig. 8e). At this point, the deformation of the wire outside the neck area is 0.24 , which is two times greater than for CuZn37 wire. From these calculations it follows that for copper wire the traditional sharpening process based on stretching in a furnace will be much more effective than for CuZn37 wire.

The next two calculations are devoted to modelling incremental stretching. The time increment value is taken to be 100 ms,

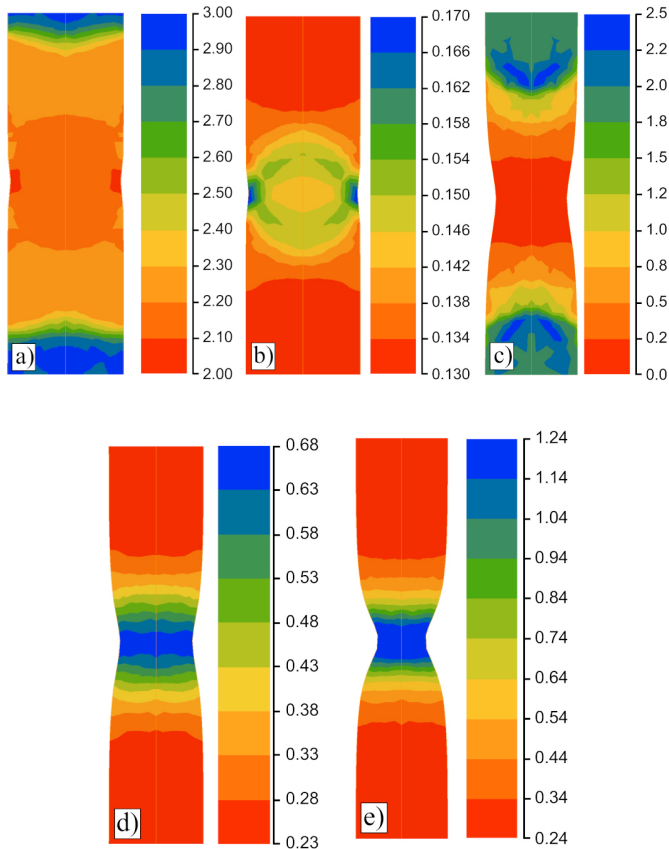

Fig. 8. Distribution of K (a, c) and effective strain (b, d, e) during the tension test of Cu wire at 200 ms (a, b), 400 ms (c, d), and 430 ms (e)

which corresponds to an average wire longitudinal deformation of 0.0625 (6.25%). The calculation assumes that after each increment of deformation, during the pause before the next stretching stage, the mechanical properties of the wire are completely restored due to the processes of recrystallization of the material. For this reason, the deformation accumulated as a result of previous increments was reset to zero in the calculation. The calculation results for the CuZn37 wire showed that during each increment of deformation, the K value in the wire changes from 6.0 to 12.0 (Fig. 9a). Such high values of K result in stable plastic deformation and even at the 6th deformation increment (600 ms) no significant necking occurs (Fig. 9c).

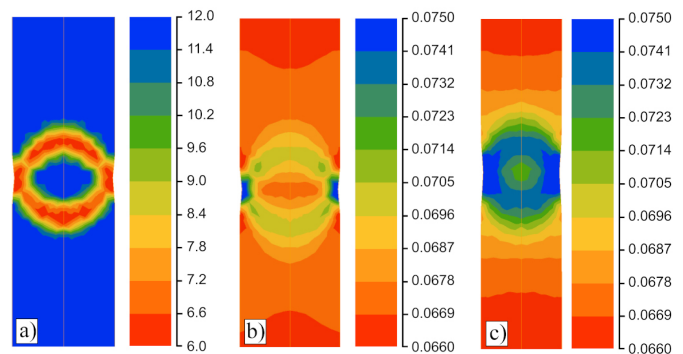

Fig. 9. Results of modelling incremental stretching of CuZn37 wire: distribution of K (a) and effective strain (b, c) for the first strain increment lasting 100 ms (a, b) and the sixth increment of deformation (c)

Application of a similar tensile regime for copper showed lower K values (3.5 – 4.1 at the first stage) and, as a consequence, much greater strain localization at the sixth stage of incremental deformation (Fig. 10).

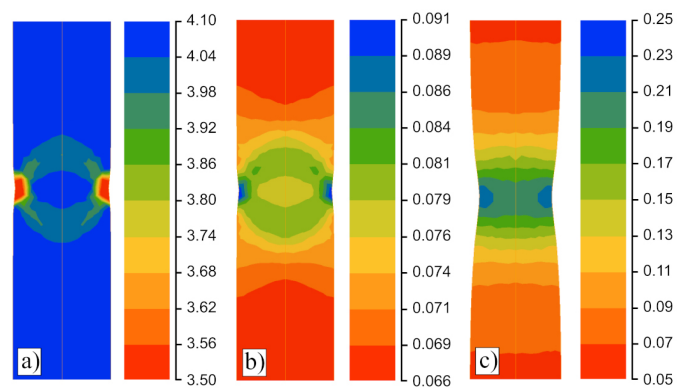

Fig. 10. Results of modelling incremental stretching of Cu wire: distribution of K (a) and effective strain (b, c) for the first strain increment lasting 100 ms (a, b) and the sixth increment of deformation (c)

The obtained calculation results allow us to draw the following preliminary conclusions.

1. The effectiveness of the method of sharpening wire by stretching it in a furnace is determined by the shape of the stress-strain relationship of the wire material at a given deformation temperature. This conclusion coincides with the results of a preliminary analysis of the stress-strain curves

given above based on the direct calculation of K from these curves (Fig. 6). Continuous furnace stretching is much more effective as a sharpening method for copper wire than for CuZn37 wire. This is explained by large values of K , which indicates greater stability of plastic deformation during tensile copper. A comparison of stress-strain curves (Fig. 5) shows that copper at the selected temperature is strengthened more uniformly than CuZn37. In the latter case, softening is observed at a strain of about 0.12 (12%) (Fig. 5a), which corresponds to negative K values.

- The initial part of the stress-strain curve (up to a strain of 0.1 (10%)) for CuZn37 is characterized by a larger average angle of inclination of the curve to the strain axis than for copper. As a consequence, the method based on incremental stretching in the conditions of the initial part of the stress-strain curve allows you to more effectively lengthen wire made of CuZn37 than copper, which we see in Figs. 9 and 10.

Since the calculations performed were aimed at a qualitative explanation of the concept, further research in order to obtain quantitative effects will be conducted based on the experiment.

The first series of experimental studies was devoted to simply stretching the wire in a furnace at the temperatures specified above. The length of the heated section of the wire was 60 mm. The experimental diameter distribution along the wire and SEM images of the wire ends after the sharpening process are shown in Fig. 11.

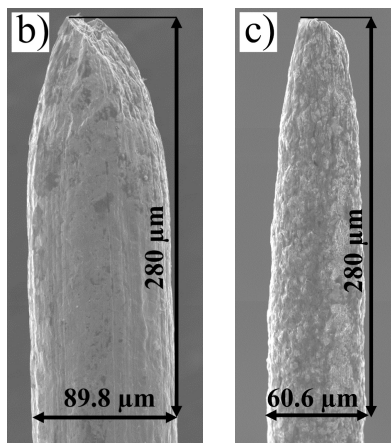
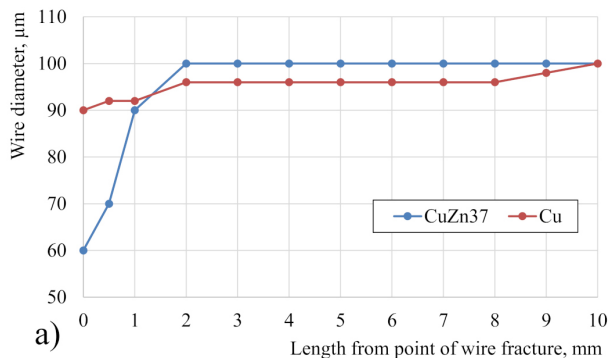

Fig. 11. The classic method of sharpening wires using stretching in a furnace: (a) graph of wire thickness after the sharpening process, (b) neck dimensions for Cu, (c) neck dimensions for the CuZn37 alloy

The change in wire diameter along its length, obtained by measuring with a micrometre with an accuracy of 0.01 mm, is shown in Fig. 11a. The measurement was conducted on the wire after it had broken, so the length of 0.0 mm in Fig. 11a corresponds to the point where the wire broke, which was approximately in the middle of the furnace length.

The resulting curve of changes in wire diameter along its length indicates a greater localization of deformation for CuZn37 wire, which qualitatively corresponds to the calculation results shown in Fig. 7. The minimum diameter of the wire at the necking site is small (0.0606 mm), but the section of the pointed wire is not long enough. For Cu wire, the wire diameter is more evenly distributed along the length, however, the minimum wire diameter achieved was about 0.090 mm.

As can be seen from Fig. 11a and 11b, it is not possible to thread a Cu wire through a drawing die with an elongation of 20%, because the sharpened zone below a diameter of 0.091 mm is less than 5 mm long. In this case, the diameter of the wire differs by less than 0.002 mm from the die diameter, hence, the threading process would be difficult or impossible. Additionally, CuZn37 wire is sharpened to a length of less than 20 mm. In this case, the end of the wire is so thin that it is difficult to pull the wire through the drawing die because it breaks off. The analysis also showed differences in the deformability of the two materials, as evidenced by the shape and dimensions of the wire neck after the break-off. This result is consistent with the K parameter, which is shown in Figs. 6–8.

Thus, wires made from both materials are difficult to sharpen by traditional oven stretching. In the case of copper, there is an insufficient reduction in the diameter of the wire with a fairly uniform distribution of the diameter along the length of the sharpened fragment. In the case of CuZn37 wire, on the contrary – with a sufficiently small diameter of the end of the wire, the length of the pointed part is too short due to the localization of deformation.

3.2. New sharpening technique based on incremental deformation and dieless drawing process

Based on equation (1) and the speeds of the slow and fast ends amounting to 15.0 and 15.7 mm/s, respectively, the calculated increment in wire deformation is $R = 0.0445$ (4.5%). According to previous theoretical analysis, such strain increment should provide stable strain, inhibit necking, and result in increased wire end sharpening efficiency, at least for CuZn37 wire. Six or seven passes of incremental deformation were performed by repeatedly pulling the sharpened section of wire until it broke. In this process, the length of the wire section to be sharpened can be as large as desired.

Finally, the CuZn37 wire after the sharpening process had a diameter of 0.072 mm (Fig. 12a), which differed from the diameter of the drawing die by 0.019 mm. In addition, the diameter of the wire at its length changes gradually. Hence, there is no problem with the wire breaking when pulling it through the drawing die. In this case, the process of threading the wire through the drawing die is simple.

It can be noted that the IDD process practically did not reduce the diameter of the copper wire. In this case, analogous

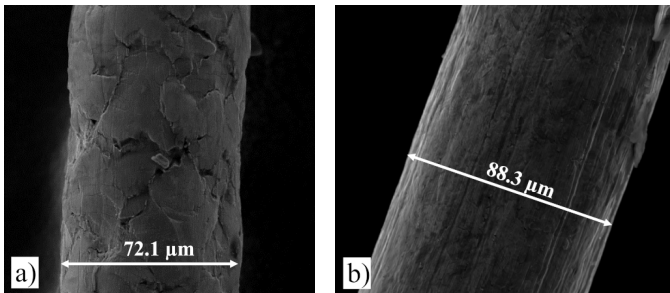

Fig. 12. Wire sharpening using the IDD technique for: (a) CuZn37, (b) Cu

to the classic sharpening process, the wire differs by less than 0.003 mm from the diameter of the die, making the threading process practically impossible. Therefore, in the remainder of the work, the drawing process was conducted only on the CuZn37 wire.

Using the proposed technique of sharpening the wire drawing process was conducted up to the diameter of 0.0205 mm. The final wire also was subjected to a sharpening process using the IDD technique for microscopic observation.

The results are shown in Fig. 13. The elongation factor for a wire after the die drawing process with a diameter of 0.0205 mm and after sharpening with a diameter of 0.01704 mm is 1.3776. This means that it is possible to thread this wire through the next drawing die without a problem even for an elongation of 30%. It should be noted that the surface roughness of the wire shown in Fig. 13a–c increased with the increasing strain in the IDD process, which is consistent with the analysis presented in the paper [27].

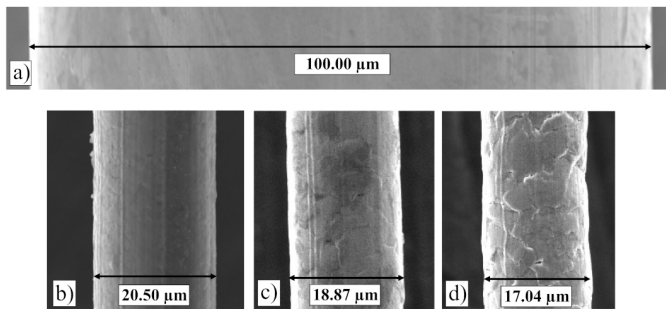

Fig. 13. CuZn37 wire: (a) input wire for the drawing process, (b) after the wire drawing process, (c) after sharpening using two passes of the IDD process, (d) after sharpening using four passes of the IDD process

4. CONCLUSIONS

1. It has been shown that classical wire sharpening by stretching it in a furnace can produce a neck. However, this neck is too short, making it impossible for the wire to pull through the drawing die.
2. A new wire sharpening technique using the incremental dieless drawing process has been developed. It has been shown that this method can be applied to materials with a high value of the K parameter. According to studies, this method is not effective for copper wires.

3. The developed sharpening technique was used in the process of wire drawing of ultra-thin CuZn37 wire (diameter 0.020 mm). Sharpening of the final wire reduces the wire diameter to the value of 0.01704 mm, which means that this method is effective for thin and ultra-thin wires.

ACKNOWLEDGEMENTS

The authors of the paper would like to thank Professor Mirosław Wróbel from the AGH University of Krakow for taking the SEM images.

REFERENCES

- [1] A.M. Baldini *et al.*, “Detailed analysis of chemical corrosion of ultra-thin wires used in drift chamber detectors,” *J. Instrum.*, vol. 16, no. 12, p. T12003, 2021, doi: [10.1088/1748-0221/16/12/t12003](https://doi.org/10.1088/1748-0221/16/12/t12003).
- [2] “Micro electronics.” Eurodrut. [Online]. Available: <https://www.eurodrut.pl/en/products/winding-wires/ultrathin-wires/> (accessed Aug. 22, 2024).
- [3] “Micro-soldering.” Katemedia Marcin Gola. [Online]. Available: <https://katemedia.pl/en/chemistry-for-electronics/820-ultra-thin-wire-0018mm-solder-wire.html> (accessed Aug. 22, 2024).
- [4] “Medical used of thin wires.” Nippon Steel SG Wire co., LTD. [Online]. Available: https://www.sgwire.com/en/products/narrow_wire.html (accessed Aug. 22, 2024).
- [5] A. Bischoff and F. Aldinger, “Ultra-thin wire for semiconductor connections,” US Patent, US4355082A, 1982 [Online]. Available: <https://patents.google.com/patent/US4355082A/en>
- [6] P. Kumar and D.G. Agnihotri, “Cold drawing process – a review,” *Int. J. Eng. Res. Appl.*, vol. 3, no. 3, pp 988–994, 2013.
- [7] S. Di Donato, L. Donati, and M. Negrozio, “Copper wire multi-pass drawing: Process modeling and optimization,” *Key Eng. Mater.*, vol. 926, pp. 499–510, 2022, doi: [10.4028/p-g4wbpz](https://doi.org/10.4028/p-g4wbpz).
- [8] S. Frank, S. Gneiger, and E. Neunteufl, “Wire based additive manufacturing of Mg alloys,” in *76th Annual IMA World Magnesium Conference*, Budapest, 2019.
- [9] A. Milenin and P. Kustrá, “Mathematical model of warm drawing process of magnesium alloys in heated dies,” *Steel Res. Int.*, vol. 81, no. 9, pp. 1251–1254, 2010.
- [10] “Esteves – drawing dies.” Estevesgroup. [Online]. Available: <https://www.estevesgroup.com/products/wire-drawing-dies> (accessed Aug. 29, 2024).
- [11] E. Felder, C. Levrau, M. Mantel, and N.G.T. Dinh, “Experimental study of the lubrication by soaps in stainless steel wire drawing,” *Proc. Inst. Mech. Eng. Part J-J. Eng. Tribol.*, vol. 225, no. 9, pp. 915–923, Sep. 2011, doi: [10.1177/1350650111415931](https://doi.org/10.1177/1350650111415931).
- [12] X.Y. Liu and S.H. Zhang, “The design of a drawing die based on the logistic function for the energy analysis of drawing force,” *Appl. Math. Model.*, vol. 109, pp. 833–847, 2022, doi: [10.1016/j.apm.2022.05.019](https://doi.org/10.1016/j.apm.2022.05.019).
- [13] “Sharpening machine.” JACOM Strategic allies. [Online]. Available: <https://jacomgroup.com/wire-drawing-machine/> (accessed Aug. 22, 2024).

- [14] “Drawing technology.” The Contenti Company. [Online]. Available: <https://contenti.com/resources/wire-drawing-process> (accessed Aug. 22, 2024).
- [15] P. Kustra, *Numeryczne modelowanie za pomocą MES procesu ciągnięcia drutów z niskoplastycznych stopów magnezu do wykorzystania w chirurgii*, AGH University of Science and Technology, Kraków, 2011.
- [16] “Sharpening machine.” Alibaba.com. [Online]. Available: https://www.alibaba.com/product-detail/Wire-pointing-machine-wire-sharpening-machine_60379555998.html (accessed Aug. 29, 2024).
- [17] V. Weiss and R.A. Kot, “Dieless wire drawing with transformation plasticity,” *Wire J.*, vol. 9, no. 9, pp. 182–189, 1969.
- [18] T. Furushima and K. Manabe, “A novel superplastic dieless drawing process of ceramic tubes,” *CIRP Ann.*, vol. 66, no. 1, pp. 265–268, 2017, doi: [10.1016/j.cirp.2017.04.118](https://doi.org/10.1016/j.cirp.2017.04.118).
- [19] A. Milenin, M. Wróbel, and P. Kustra, “Investigation of the workability and surface roughness of thin brass wires in various dieless drawing technologies,” *Arch. Civ. Mech. Eng.*, vol. 22, no. 1, p. 10, 2022, doi: [10.1007/s43452-021-00331-2](https://doi.org/10.1007/s43452-021-00331-2).
- [20] Y. Li, N. R. Quick, and A. Kar, “Dieless laser drawing of fine metal wires,” *J. Mater. Process. Technol.*, vol. 123, no. 3, pp. 451–458, May 2002, doi: [10.1016/S0924-0136\(02\)00110-3](https://doi.org/10.1016/S0924-0136(02)00110-3).
- [21] P. Tiernan and M. T. Hillery, “Dieless wire drawing—an experimental and numerical analysis,” *J. Mater. Process. Technol.*, vol. 155–156, no. 1–3, pp. 1178–1183, Nov. 2004, doi: [10.1016/j.jmatprotec.2004.04.175](https://doi.org/10.1016/j.jmatprotec.2004.04.175).
- [22] S. Supriadi, T. Furushima, and K.-I. Manabe, “Development of precision profile control system with fuzzy model and correction function for tube dieless drawing,” *J. Solid Mech. Mater. Eng.*, vol. 5, no. 12, pp. 1059–1070, 2011, doi: [10.1299/jmmp.5.1059](https://doi.org/10.1299/jmmp.5.1059).
- [23] Y. Yi, K. Shinomiya, R. Kobayashi, H. Komine, S. Yoshihara, and T. Furushima, “A novel superplastic dieless drawing using fracture phenomenon for fabrication of metal tubular microneedles,” *CIRP Ann.*, vol. 71, no. 1, pp. 237–240, Jan. 2022, doi: [10.1016/J.CIRP.2022.03.037](https://doi.org/10.1016/J.CIRP.2022.03.037).
- [24] M. Braatz, J. Bohlen, and N. Ben Khalifa, “Process window and mechanical properties for thin magnesium- and zinc-wires in dieless wire drawing,” *Int. J. Mater. Form.*, vol. 17, no. 5, p. 46, 2024, doi: [10.1007/s12289-024-01848-6](https://doi.org/10.1007/s12289-024-01848-6).
- [25] P. Du, S. Furusawa, and T. Furushima, “Continuous observation of twinning and dynamic recrystallization in ZM21 magnesium alloy tubes during locally heated dieless drawing,” *J. Magnes. Alloy.*, vol. 10, no. 3, pp. 730–742, Mar. 2022, doi: [10.1016/j.jma.2021.06.001](https://doi.org/10.1016/j.jma.2021.06.001).
- [26] P. Du, T. Kishimoto, and T. Furushima, “Uniforming outer diameter by control of microstructural evolution for biodegradable ZM21 magnesium alloy tube during dieless drawing,” *J. Mater. Process. Technol.*, vol. 312, p. 117831, Mar. 2023, doi: [10.1016/j.jmatprotec.2022.117831](https://doi.org/10.1016/j.jmatprotec.2022.117831).
- [27] A. Milenin, M. Wróbel, P. Kustra, and J. Němeček, “Experimental and numerical study of surface roughness of thin brass wire processed by different dieless drawing processes,” *Materials*, vol. 15, no. 1, Dec. 2021, doi: [10.3390/ma15010035](https://doi.org/10.3390/ma15010035).
- [28] A. Milenin, “Rheology-based approach of design the dieless drawing processes,” *Arch. Civ. Mech. Eng.*, vol. 18, no. 4, pp. 1309–1317, 2018, doi: [10.1016/j.acme.2018.04.003](https://doi.org/10.1016/j.acme.2018.04.003).
- [29] A. Considère, “Mémoire sur l’emploi du fer et de l’acier dans les constructions,” *Ann. des Ponts Chaussées*, vol. 34, no. 2, pp. 574–595, 1885.
- [30] R.N. Wright and E.A. Wright, “Basic analysis of dieless drawing,” *Wire J. Int.*, vol. 33, pp. 138–143, 2000.
- [31] O.I. Bylya, M.K. Sarangi, N. Rohit, A. Nayak, R.A. Vasin, and P.L. Blackwell, “Simulation of the Material Softening During Hot Metal Forming,” *Arch. Metall. Mater.*, vol. 60, no. 3, pp. 1887–1893, Sep. 2015, doi: [10.1515/amm-2015-0322](https://doi.org/10.1515/amm-2015-0322).
- [32] O.I. Bylya, T. Khismatullin, P. Blackwell, and R.A. Vasin, “The effect of elasto-plastic properties of materials on their formability by flow forming,” *J. Mater. Process. Technol.*, vol. 252, pp. 34–44, Feb. 2018, doi: [10.1016/j.jmatprotec.2017.09.007](https://doi.org/10.1016/j.jmatprotec.2017.09.007).
- [33] G.D. Slomchack, A.A. Milenin, I. Mamuzić, and F. Vodopivec, “A mathematical model of the formation of the plastic deformation zone in the rolling of rheologically complex metals and alloys,” *J. Mater. Process. Technol.*, vol. 58, no. 2–3, pp. 184–188, Mar. 1996, doi: [10.1016/0924-0136\(95\)02099-3](https://doi.org/10.1016/0924-0136(95)02099-3).
- [34] A. Milenin, T. Furushima, P. Du, and V. Pidvysots’kyy, “Improving the workability of materials during the dieless drawing processes by multi-pass incremental deformation,” *Arch. Civ. Mech. Eng.*, vol. 20, no. 86, pp. 1–14, 2020, doi: [10.1007/s43452-020-00092-4](https://doi.org/10.1007/s43452-020-00092-4).