

THE SIMULTANEOUS EFFECT OF THE OPERATING TEMPERATURE AND SOLAR RADIATION ON THE EFFICIENCY OF PHOTOVOLTAIC PANELS

D. HEIM¹

The proper designing of PV systems requires the use of advanced building energy simulation techniques. It allows to design the best position of the PV array, as well as the right quantity of produced energy in different cases. On the other hand the PV efficiency is not only a constant value but changes according to temperature and solar radiation. This paper is devoted to estimate the simultaneous effect of both weather factors on PV efficiency. The task was achieved by numerical simulation and ESP-r software. Computer simulations have been carried out with the use of the Typical Meteorological Year data for Warsaw (52°N 21°E). The greatest influence of temperature on the efficiency of solar energy conversion was observed for crystalline silicon cells. The influence of the boundary conditions assumed in the study is ignored for amorphous silicon cells in the summer period and regardless of the material type in the winter period.

Key words: photovoltaic, efficiency, simulation, operating temperature, solar radiation.

1. INTRODUCTION

There has been a growing interest in photovoltaic (PV) systems as unconventional sources of energy acquisition. PV systems convert solar radiation directly into electrical energy without making noise or causing other types of pollution, are environmentally friendly and do not adversely affect the natural environment.

The photovoltaic effect was first observed by the French physicist Edmond Becquerel in 1839. It was not until the late 1950s that PV cells were applied in space technologies to power satellites. The 1960s witnessed considerable technological progress in the field of photovoltaics as lightweight and reliable energy sources were required in space vehicles. PV cells have also been used in the construction industry as systems integrated with the building, Building Integrated Photovoltaic (BIPV), and the heat and power system in buildings since the 1980s, Sick and Erge [8].

Adequate numerical methods that use coupled processes of conversion of solar radiation into electric and thermal energy are needed to design PV systems appropriately, Buresh [1], Clarke [2]. The optimum position of PV panels can be defined at the

¹ Department of Building Physics and Building Materials, Technical University of Lodz, Poland, e-mail: dariusz.heim@p.lodz.pl

design stage to obtain the greatest possible capacity of energy produced in different geographic, terrain and climatic conditions. Software tools have full meteorological databases (hourly or averaged monthly data) related to both direct and diffuse solar radiation as well as temperature.

Combining PV panel modelling and building energy modelling is a complex issue. While an ability to convert efficiently direct or diffuse radiation into electric energy is the only important parameter in PV cells, other processes have to be taken into account in building modelling and hybrid PV façades. Those are: solar radiation reflected from the module surface, radiation converted into heat energy and energy transfer by conduction, convection and radiation. Both basic meteorological parameters and special weather factors such as snow and its cover thickness affect cell operation. However, current and voltage ($I - V$) characteristics of a panel are the most important parameters. They are mostly measured in stationary conditions (because of solar radiation or temperature) that are changeable throughout the annual operation of a panel, which considerably influences its final efficiency.

The aim of this study is to analyse the simultaneous influence of operating temperature (temperature of PV cell) and solar radiation changes on the efficiency of silicon PV cells.

2. PV BACKGROUND

PV systems were rarely used in overhead applications due to high production costs and the high market value of energy in the period between the 1950s and the 1970s. Their application became more viable only after price increases following the petroleum crisis in the mid 1970s making PV systems more popular. An average increase of 25% in PV module production has been recorded in the last ten years.

A PV cell, usually made of silicon, is the main element of PV systems. The greatest efficiencies of solar radiation conversion reaching 30% are reported for gallium arsenide (GaAs) cells. They are, however, expensive and are mostly used in space applications. Amorphous silicon thin film cells that use cost-effective materials have been increasingly popular as easier and less energy-intensive to manufacture. They are produced in vacuum chambers where a thin film of amorphous silicon is deposited on the substrate after gas decomposition in a glow discharge. Glass, ceramic or a plastic layer can be used as substrates for amorphous silicon deposition and larger individual cell surfaces can be obtained. Crystalline silicon cells and polycrystalline silicon cells may become outdated as amorphous silicon cells, slightly less efficient but more cost-effective in production, take over. Research is also carried out into other cell types among which technologies based on polycrystalline semiconductor compounds CuInSe_2 (copper-indium selenide) and CdTe (cadmium telluride) seem to be the most promising ones, Sick and Erge [8], Buresh [1].

The power of a typical individual cell is between one and two watts which is insufficient for most applications. However, higher voltages and currents can be obtained by connecting cells in series or in parallel into a greater unit called a PV module. The power of such modules is expressed in watt peaks (Wp), that is power supplied in standard test conditions (STC), and it usually ranges between 30 and 120 Wp. Standard test conditions are defined as operating temperature of 25°C, solar radiation of 1.5 AM and power 1 000 W/m². PV systems rarely work under standard test conditions and operating conditions are mostly less favourable due to a lower value and smaller incidence angle of solar radiation as well as higher temperatures. It is therefore useful to know I – V characteristics of module efficiencies across a variety of operating conditions.

A number of modules can be interconnected into panels within PV systems to obtain greater ratings. Output current strictly depends on insolation, but can be increased when panels are connected in parallel. Voltage obtained from a module does not depend considerably on the insolation level and a PV panel can be designed to work at practically any voltage, even up to a few hundred Volts, when modules are connected in series. PV panels can work only at 12 or 14 V for small-scale applications while large panels in on-grid applications can work at 240 V or more.

3. PROBLEM DEFINITION

A PV cell is an active transducer and does not have to be polarised with external power. Cell efficiency which depends on, for instance, the material type (Fig. 1) is one of basic characteristic properties of PV cells. It changes together with solar radiation and the operating temperature. Two main factors are associated with the physical aspect of a drop in PV cell efficiency as temperature increases:

- an increase in the amplitude of oscillations of the crystalline network which inhibits the flow of charge carriers by decreasing their mobility,
- loss of the diffusion ability of photogenerated loads through the junction.

The former inhibits the operation of silicon cells even at room temperatures as they work below their maximum efficiency. The latter does not considerably influence the efficiency of energy conversion by a silicon cell provided operating temperature does not exceed 300°C. The N-type silicon loses its electron character and the number of electrons and holes is comparable. At the same time, the P-type semiconductor becomes similar to the I-type semiconductor at higher temperatures, which has two effects:

- thermally generated charge carriers have so much energy that they cross the junction in both directions,
- the junction disappears as the N- and P-regions are no longer present on its sides.

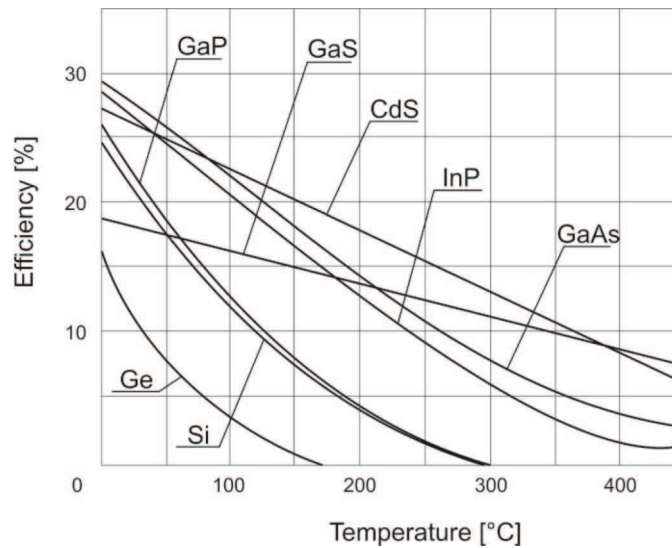

Fig. 1. Influence of temperature on PV cells efficiency, Lewandowski [6].

Rys. 1. Wpływ temperatury na sprawność ogniw PV z różnych materiałów Lewandowski [6]

The efficiency of solar energy conversion into electric energy η is given by:

$$(3.1) \quad \eta = \frac{I \times V}{E \times A} \times 100\%$$

where I and V are the current and voltage of the photoelectric element, respectively, E is solar radiation energy and A is the surface area of the PV panel. The influence of temperature on the efficiency of various cell types is given in Figure 1 where: GaS – gallium sulfate, GaP – gallium phosphate, CdS – cadmium sulfate, InP – indium phosphate, GaAs – gallium arsenide, Ge – germanium, Si – silicon. As literature data show, the mean decline in cell efficiency depending on the material is:

- 0.5%/°C for polycrystalline silicon by King, Boysen and Kratochvil [4],
- 0.25%/°C by King, Kratochvil, Boysen, Bower [5] and 0.22%/°C by Ramsome and Wohlgemut [7] for amorphous silicon,
- 0.4%/°C by Sick and Erge [8] and 0.45%/°C by Ramsome and Wohlgemut [7] for crystalline silicon.

4. PV SYSTEM MODELLING

Most contemporary simulation software tools are based on numerical methods of partly differential equation solving. Numerical techniques seem to be the method of choice as they guarantee high accuracy by retaining the integrity of spatial and time variables while the error is easy to estimate. Solutions can be obtained for specific time periods and selected parameters can be set to change in time contrary to analytical techniques.

An integrated approach to simulation issues is of great help in real and accurate physical rendition of the building behaviour and related elements (e.g. building systems and the equipment used to produce energy from renewable sources) including their mutual relationships. Unlike analytical methods, numerical analysis is useful in solving coupled processes when a predefined degree of accuracy is considered. They allow basic physical parameters (temperature, heat flow, etc.) to be calculated at defined points of the system: nodes representing given subareas such as a wall part, window, room, an element of the heating or conditioning system or a device used to obtain renewable energy. An example of correlations in a module-plant-building system is given schematically in Figure 2.

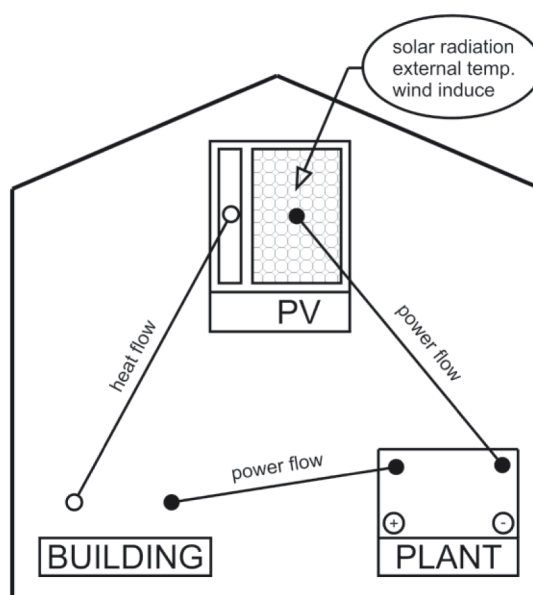

Fig. 2. Energy flow path between a PV module, plant and building.

Rys. 2. Ścieżki przepływu energii pomiędzy modułem PV, instalacją a budynkiem

Energy System Performance ESP-r, Clarke [2] is a tool for building energy simulation that uses the finite volume method highly suitable for the analysis of PV system performance. The energy capacity obtained from PV systems in the conditions determined by the module position can be calculated using both meteorological data from the area and material and electrical characteristics of the modules. ESP-r can be used to model components with special properties (including elements of renewable energy systems) and to calculate the performance of different PV cell types. The program has a special module in which properties of construction elements can be adjusted to include special materials such as thermochromic windows, PV cells, phase change materials and others Clarke and Kelly [3], Thevenard [9]. To capture the actual

structure of a PV cell, external construction layers are defined as being transparent. The algorithm that solves the issue of solar energy transfer and conversion in a PV cell includes transmission, absorption and emission depending on the incidence angle. It also includes the effect of internal reflections to finally determine the capacity of generated electrical energy based on the radiation that reaches the panel from outside. Solar radiation energy that has not been converted into electrical energy is finally considered in the energy equilibrium of a given node element as additional heat energy which causes an increase in the temperature of a layer and other layers that are in thermal contact with it. Processes of conversion of solar radiation into electrical energy and heat energy are analysed as coupled issues.

Façade-integrated PV modules, treated as a hybrid component in a system transfer of heat energy and electrical energy, are shown in Figure 2 as an example of PV system elements.

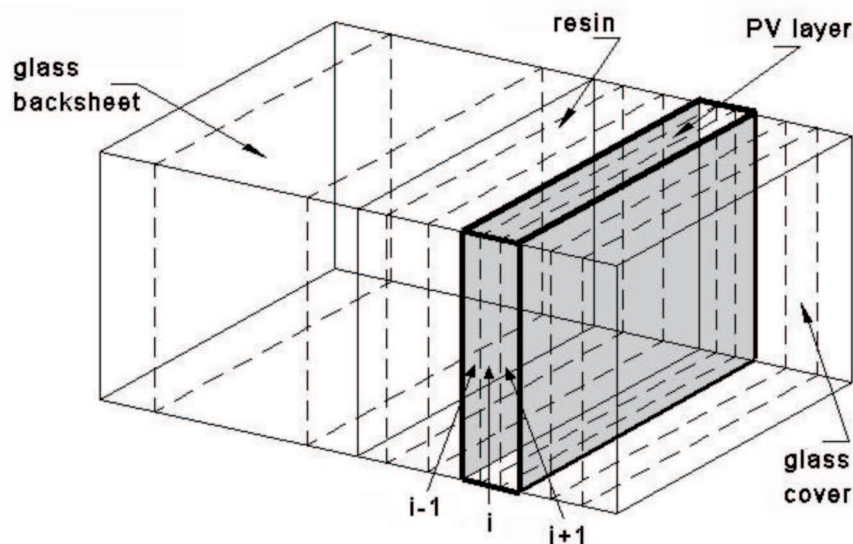

Fig. 3. A four-layer construction of a PV panel with a PV layer (grey).

Rys. 3. Czwierwarstwowa konstrukcja panelu PV z warstwą fotowoltaiczną (kolor szary)

The model of a four-layer PV panel is given in Figure 4. It consists of photovoltaic material, a conductor, contact and frame. Solar radiation penetrates the PV layer (i) through the glass cover. The amount of incident solar radiation is a function of the surface tilt angle, sun position, shading and instantaneous weather conditions. The equation describing the flow of the energy flux in each node element defined as a PV layer (grey) is as follows, Clarke and Kelly [3]:

$$\begin{aligned}
 (4.1) \quad & \left(\frac{2\rho c_i}{\Delta t} + \frac{k_{i,i+1} + k_{i,i-1}}{\Delta x_i^2} \right) T_i^{t+\Delta t} - \left(\frac{k_{i,i+1}\theta_{i-1}^{t+\Delta t} + k_{i,i-1}\theta_{i+1}^{t+\Delta t}}{\Delta x_i^2} \right) - \frac{\alpha_i^{t+\Delta t}}{\Delta V} = \\
 & = \left(\frac{2\rho c_i}{\Delta t} + \frac{k_{i,i+1} + k_{i,i-1}}{\Delta x_i^2} \right) T_i^t + \left(\frac{k_{i,i+1}\theta_{i-1}^t + k_{i,i-1}\theta_{i+1}^t}{\Delta x_i^2} \right) + \frac{\alpha_i^t}{\Delta V}
 \end{aligned}$$

where: ρ – density [kg/m³], c – specific heat [J/(kgK)], Δt – length of the time step, k – Boltzmann constant, θ – temperature [°C], ΔV – finite volume [m³].

Solar radiation absorbed α_i is converted into heat α'_i and electrical energy q_{ei} inside the PV layer, which consequently reduces a temperature increase in the layer in comparison with a layer constructed using typical material. The amount of solar radiation absorbed and converted into heat is expressed by the equation:

$$(4.2) \quad \alpha'_i = \alpha_i - q_{ei}$$

where: α is total absorbed energy of solar radiation [W].

The value of electrical power q_{ei} is calculated using the equation below, derived from the standard model of a PV cell described by Buresch [1]:

$$(4.3) \quad q_{ei} = nc \left[V_i I_g \left(1 - \exp \left[\frac{eV_i}{\lambda k T_i} \right] \right) - V_i I_{SC} \frac{\alpha'_i}{\alpha'_{iref}} \right]$$

where: α'_i – is the conversion of absorbed solar radiation energy into electrical energy, nc – the number of cells in a panel, V_i – voltage [V], I_i – current amperage [A], I_{SC} – amperage of short circuit current [A], e – electrical charge [C], λ – correction coefficient, and ref refers to the characteristics obtained in specified and standard measurement conditions.

Temperature T_i [K] is the (node) temperature of the PV material calculated using the numerical model based on equations of heat conduction, while light generating current is calculated as a function of solar energy α_i absorbed by the PV layer. It should be noticed, however, that equations of equilibrium of electrical energy of a PV model are strongly correlated with a modified model of heat transfer in order to obtain the input rating at respective nodes of the power system. A combined model of light, heat and electrical power transfer was developed and entered into ESP-r, Clarke and Kelly [3]. The formulae describing power transfer occurring during the application of the above components were used performing the same transformations as in the thermal model: conversion of the heat and mass flow into the flow of an electrical energy flux.

5. NUMERICAL ANALYSES

The tilt angle was assumed to be 45⁰. The modules were orientated southwards and were located in an open area to avoid undue shading elements or elements that can

reflect solar radiation directly towards them. Boundary condition changes both on the front part of the elements with PV cells and the rear part of the modules were consistent with meteorological weather data for the temperate climate of Central Europe (Warsaw – 52°N 21°E) as required by the six main basic weather parameters used in ESP-r.

For the purposes of the analysis, one week in summer and one week in winter characterised by the greatest and the smallest values of solar radiation were selected from a meteorological data set. The history of solar radiation converted into electrical energy in two selected periods throughout the year for one module with a constant efficiency and two silicon-cell modules are given in Figures 4 and 5. The influence of the cell type and its I – V characteristics on the electrical energy capacity is shown. The electrical energy capacity depends on the material type and is considerably lower for the amorphous silicon cell module than for the crystalline silicon cell module, which indicates a higher efficiency of solar radiation conversion by crystalline silicon. At the same time, both values of generated energy are considerably smaller in comparison with the module for which a constant generation efficiency (independent of temperature) was assumed. It should be remembered that generated energy values obtained depending on the cell type are for specific module models with strictly defined parameters and I – V characteristics. The analyses only show the influence of specific material parameters and characteristics on the energy capacity obtained from various PV modules.

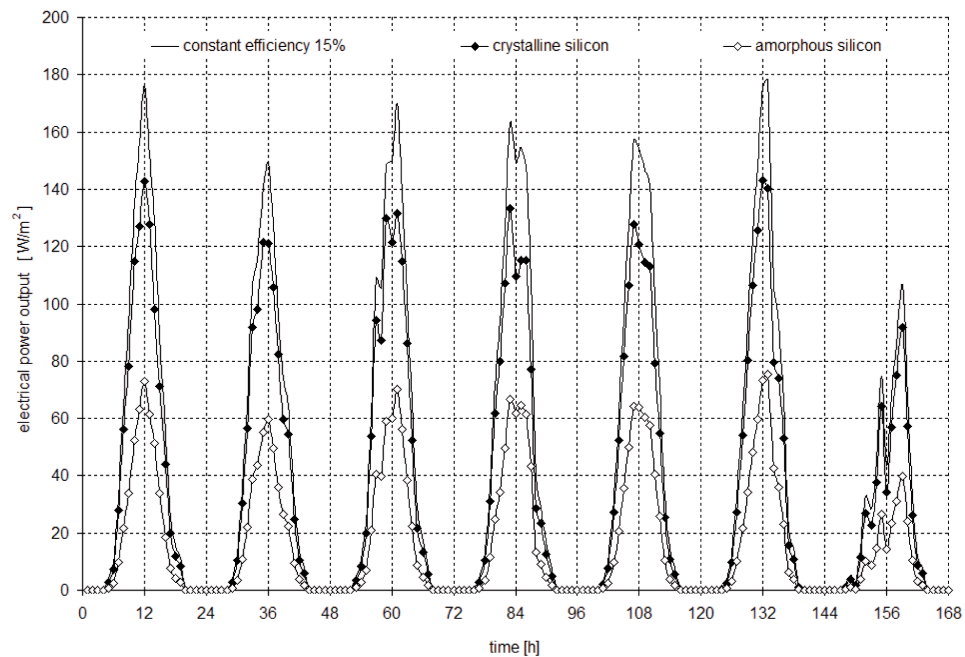

Fig. 4. Electrical energy obtained from PV modules in a selected week in summer.
Rys. 4. Strumień energii otrzymywanej z modułów PV w wybranym tygodniu lata

Monthly electrical energy yields from PV modules that use different cell types over one year are listed in Figure 6. The results show the influence that the assumption of constant cell efficiency for which a decline in the efficiency together with a temperature increase is ignored has on the energy generated. A small increase in the efficiency (knowing that the efficiency of crystalline silicon cells is 13% and that of amorphous silicon is 7%) when the relationship with temperature is ignored gives a twice as large electrical energy yield from solar radiation. This demonstrates the importance of accurate modelling of renewable energy production equipment to capture the actual nature of the process and the accuracy of results.

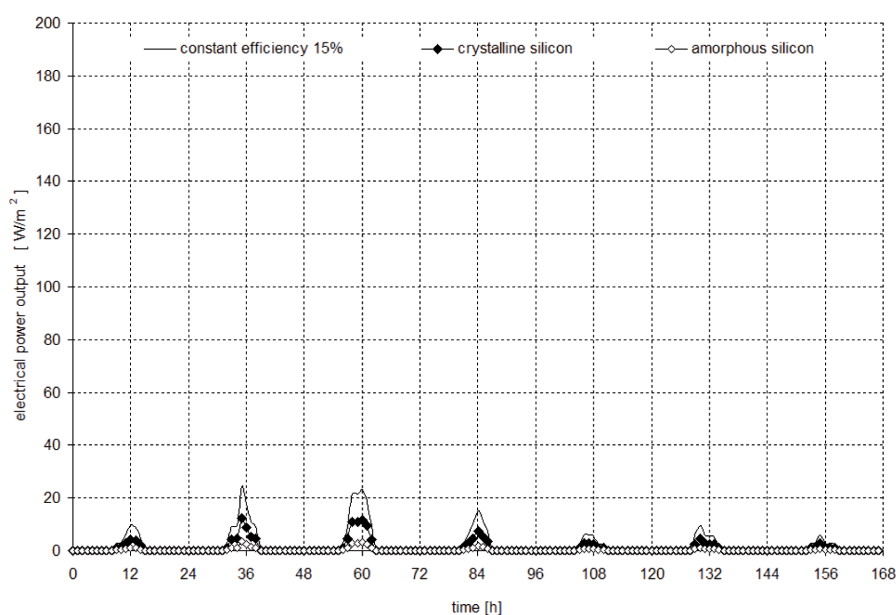

Fig. 5. Electrical energy obtained from PV modules in a selected week in winter.
Rys. 5. Strumień energii otrzymywanej z modułów PV w wybranym tygodniu zimy

The influence of temperature and intensity of solar radiation on the efficiency of solar radiation conversion depending on the cell type is given in Figures 7 and 9 (for the summer period) and Figures 8 and 10 (for the winter period). A strong correlation between the efficiency and both temperature and solar radiation is observed for crystalline silicon cells. An increase in the operating temperature of the cells and a drop in the radiation causes a decline in the efficiency of electrical energy generated from solar radiation. It is especially noticeable in the summer period during which the panels' operating temperature reaches 80°C as a result of a partial photothermal conversion of solar radiation reaching the panel. At the same time, the efficiency of such cells changes by 2.5% in the range of constant temperature (25°C) or solar

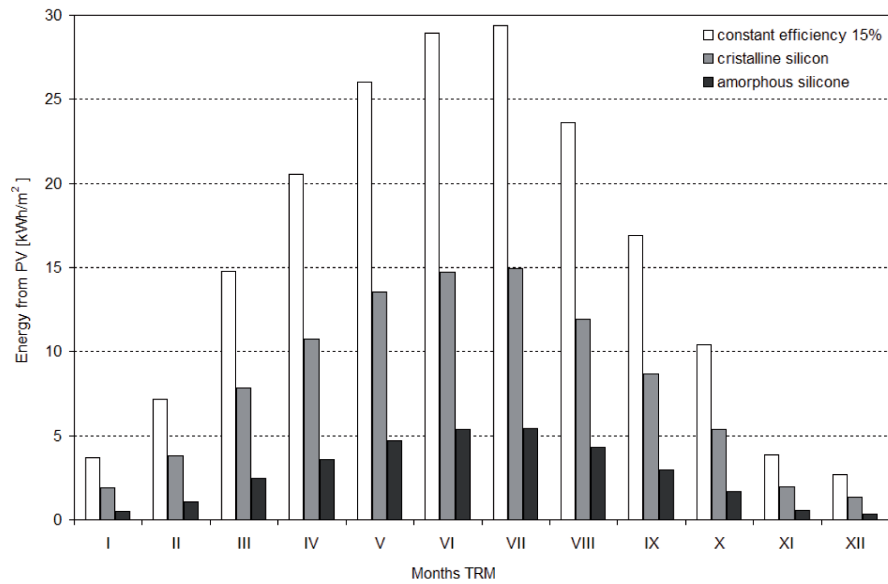

Fig. 6. Electrical energy capacity generated in individual months.

Rys. 6. Ilość energii elektrycznej generowanej w poszczególnych miesiącach

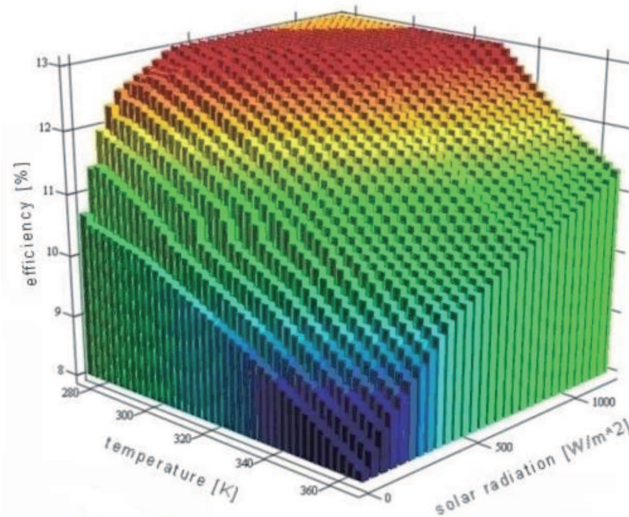

Fig. 7. The influence of operating temperature and solar radiation on the efficiency of crystalline silicon cells over one week in summertime.

Rys. 7. Wpływ temperatury pracy i promieniowania słonecznego na efektywność ogniw z krzemu krystalicznego w analizowanym tygodniu lata

radiation ($1\ 000\text{W}/\text{m}^2$) analysed. It changes, however, from 0% to 13% when both factors are considered simultaneously. The constant maximum efficiency of 13% occurs only when the operating temperature does not exceed 25°C and solar radiation that reaches the panels remains over $1\ 000\text{W}/\text{m}^2$. This relationship is noticeable in cells made using crystalline silicon whose efficiency is twice as high as that of amorphous silicon in the case analysed here. No significant correlation between the efficiency and temperature was observed for amorphous silicon cells. However, their efficiency decreases significantly (from 6% to 3%) as the intensity of solar radiation changes.

The summer period encourages an increase in the modules' operating temperature, which indicates that temperature as well as appropriately high solar radiation values influence PV system efficiency. Temperature values that are too high may lead to an almost zero efficiency for solar radiation electrical energy to be generated.

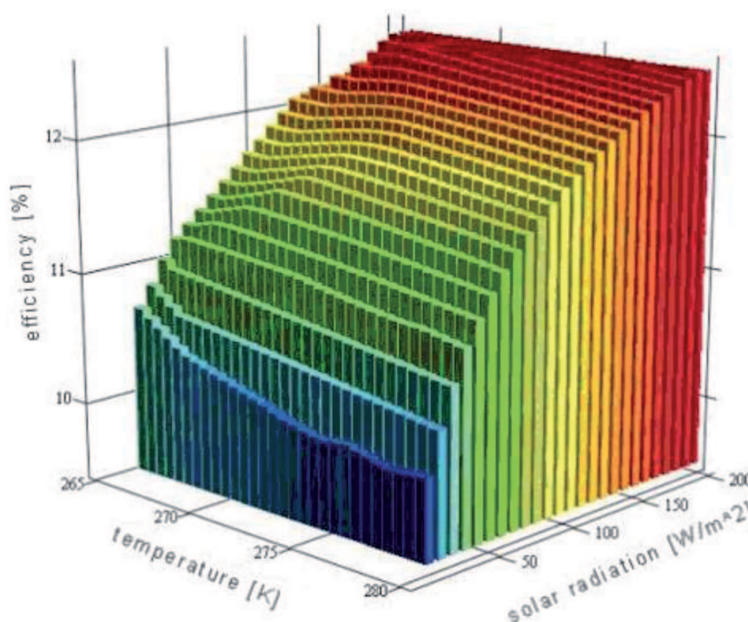

Fig. 8. The influence of operating temperature and solar radiation on the efficiency of crystalline silicon cells over one week in wintertime.

Rys. 8. Wpływ temperatury pracy i promieniowania słonecznego na efektywność ogniw z krzemu krystalicznego w analizowanym tygodniu zimy

The results are consistent with laboratory examinations that show a decline in PV cell efficiency for a constant solar radiation value and an increase in the operating temperature. At the same time, the distributions show the accuracy of the calculation algorithm that takes into account the influence of the two components used in ESP-r to perform simulations.

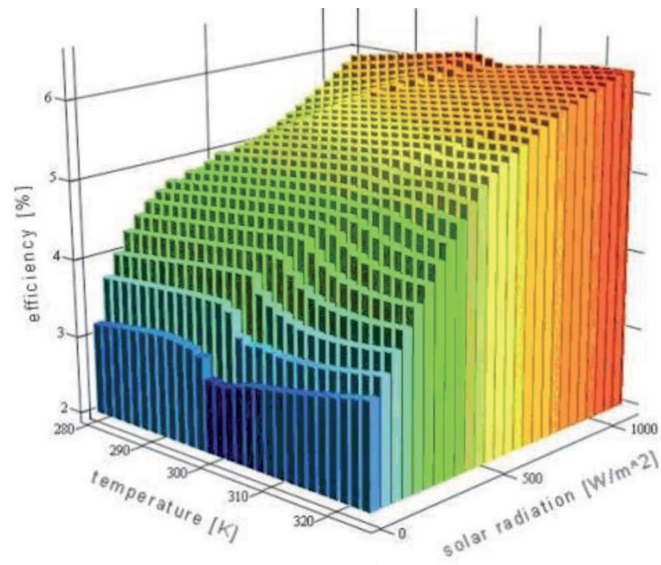

Fig. 9. The influence of operating temperature and solar radiation on the efficiency of amorphous silicon cells over one week in summertime.

Rys. 9. Wpływ temperatury pracy i promieniowania słonecznego na efektywność ogniw z krzemu amorficznego w analizowanym tygodniu lata

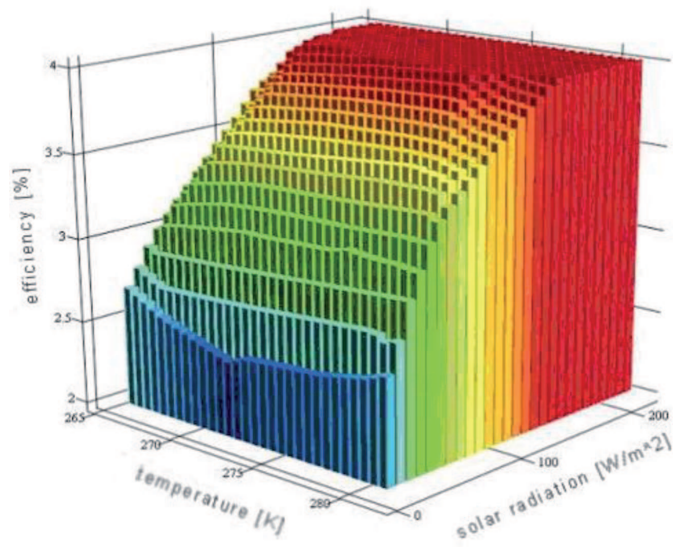

Fig. 10. The influence of operating temperature and solar radiation on the efficiency of amorphous silicon cells over one week in wintertime.

Rys. 10. Wpływ temperatury pracy i promieniowania słonecznego na efektywność ogniw z krzemu amorficznego w analizowanym tygodniu zimy

6. CONCLUSIONS

The results of the simulation analyses show that not only properties of PV systems such as

- the material used in cell production,
- current and voltage characteristics of the modules, their location and connection with the grid,
- optical and geometric properties of the panel absorbing solar radiation,
- the azimuth and the tilt angle,
- positioning in relation to the building,
- integration with the power system,

but also changes in their efficiency depending on temperature and solar radiation should be considered when modelling PV systems.

The efficiency of crystalline silicon cells is twice as high, which is confirmed by the present results. Insolation and variable cell operating temperature also play an important role, influence the efficiency and depend on the location of the panel (the influence of local climatic conditions).

The greatest influence of temperature on the efficiency of solar energy conversion was observed for crystalline silicon cells. The influence of the calculation conditions assumed in the study was ignored for amorphous silicon cells in the summer period and regardless of the material type in the winter period. However, the influence of the varying intensity of solar radiation whose decline considerably reduces photoelectric conversion both in winter and in summer was significant.

The capacity of electrical energy obtained from PV systems can be estimated using the results of ESP-r simulations. They show that PV systems significantly contribute to saving electrical energy derived from conventional sources, especially in summertime. They help to design PV systems that will guarantee maximum benefits and will bring considerable energy savings in the period when solar radiation values are high.

REFERENCES

1. M. BURESH, *Photovoltaic energy systems – design and installation*, McGraw-Hill, New York 1983.
2. J.A. CLARKE, *Energy simulation in building design*, 2nd edition, Butterworth–Heinemann, Oxford 2001.
3. J.A. CLARKE, N.J. KELLY, *Integrating power flow modelling with building simulation*, *Energy and Buildings*, **33**, 4, 333-40, 2001.
4. D.L. KING, W.E. BOYSEN, J.A. KRATOCHVIL, *Analysis of factors influencing the annual energy production of photovoltaic systems*. Proc. 29th IEEE PVSC, 1356-61, New Orleans 2002.
5. D.L. KING, J.A. KRATOCHVIL, W.E. BOYSEN, W.I. BOWER, *Field experience with a new performance characterization procedure for photovoltaic arrays*, Proc. 2nd World & Exhibition on photovoltaic solar energy conversion, 1947-52, Vienna 1998.

6. W.M. LEWANDOWSKI, *Proekologiczne źródła energii odnawialnej*, Wydawnictwo Naukowo-Techniczne, Warszawa 2001.
7. S.J. RAMSOME, J.H. WOHLGEMUT, *kWh/kWp dependency on PV technology and balance of the systems performance*. Proc. 29th IEEE PVSC, 1420-23, New Orleans 2002.
8. F. SICK, T. ERGE (ed.), *Photovoltaic in Buildings: a design handbook for architects and engineers*, James & James, 1996.
9. D. THEVENARD, *Review and recommendation for improving the modelling of building integrated photovoltaic systems*, Proc. 9th International IBPSA Conference, 1221-28, Montreal 2005.

JEDNOCZESNY WPLYW TEMPERATURY PRACY ORAZ PROMIENIOWANIA SŁONECZNEGO NA WYDAJNOŚĆ OGNIW FOTOWOLTAICZNYCH

Streszczenie

Fotowoltaika jest najbardziej popularnym systemem konwersji energii promieniowania słonecznego na prąd elektryczny. Energia elektryczna produkowana przez systemy PV może być spożytkowana na potrzeby danego użytkownika, zaś jej ewentualna nadwyżka sprzedana bezpośrednio do sieci elektroenergetycznej. Prawidłowe zaprojektowanie systemu PV wymaga użycia zaawansowanych technik symulacji energetycznych budynków. Pozwalają one na wybór najlepszego usytuowania oraz dają prawidłową informację na temat możliwej do uzyskania ilości energii.

Z innej jednak strony, systemy PV nie posiadają stałej wydajności a jest ona zależna od temperatury pracy oraz docierającego do ogniwa promieniowania słonecznego. Wpływ temperatury na wydajność ogniwa PV jest dobrze znana z literatury przedmiotu. Artykuł ten ma natomiast na celu oszacowanie jednoczesnego wpływu temperatury i promieniowania na wydajność ogniwa. Główny cel osiągnięty został poprzez obliczenia symulacyjne z zastosowaniem zaawansowanego narzędzia obliczeniowego, programu ESP-r. Obliczenia przeprowadzono dla danych meteorologicznych Warszawy. Uwzględniono zarówno promieniowanie bezpośrednie jak i rozproszone. Wyznaczono ilość wyprodukowanej energii dla wybranych tygodni oraz wpływ temperatury i promieniowania słonecznego na wydajność ogniwa PV.

Największy wpływ temperatury na wydajność konwersji energii słonecznej zaobserwowano latem dla ogniwa wykonanych z krzemu krystalicznego. Dla ogniwa wykonanych z krzemu amorficznego w okresie lata oraz bez względu na rodzaj materiału w okresie zimy wpływ temperatury dla przyjętych warunków obliczeniowych był pomijany. Istotny natomiast był wpływ zmieniającego się natężenia promieniowania, którego spadek znacznie obniża zdolność konwersji fotoelektrycznej zarówno w okresie zimy jak i lata.

*Remarks on the paper should be
sent to the Editorial Office
no later than December 30, 2011*

*Received July 15, 2011
revised version
September 10, 2011*