

Finite-dimensional approximations of distributed RC networks

W. MITKOWSKI*

AGH University of Science and Technology, Faculty of Electrical Engineering, Automatics, Computer Science and Biomedical Engineering, Department of Automatics and Biomedical Engineering, 30/B1 A. Mickiewicza Ave., 30-059 Kraków, Poland

Abstract. Spectral properties of ladder and spatial electrical networks are considered. Dynamic properties of the networks are characterised by eigenvalues of the Jacobi cyclic state matrix. The effective formulas for eigenvalues of appropriate uniform systems are given. Numerical calculations were made using MATLAB.

Key words: ladder and ring electrical networks, finite-dimensional approximations, eigenvalues of ladder networks, Jacobi matrix.

1. Introduction

The current microelectronics manufacturing technologies allow you to make new items, unknown in classical electronics – all kinds of RC lines [1]. RC lines represent the structures of a distributed RC system [2], which merge infinite number of individual elements R and C into one microelectronic element. In some cases, systems with large numbers of elements R and C may be replaced with one element of a distributed RC system. The simplest and the most popular form of distributed RC system structure is RC line, usually approximated with RC circuit ladder (see Fig. 1). The structure of the RC line (and consequently the structure of the ladder) depends on the technology of its implementation. RC line is made in layers – it is composed of three layers: conductive, resistive and dielectric. The conductive and resistive layers are separated by a dielectric layer forming distributed capacity. RC line is an elementary “cell” of more complex structures of a distributed RC system. RC line is a special case of RCR line (see Fig. 2) or RRC line (see Fig. 3). For example, RCR line has a similar structure to the RC lines, except that in place of the conductive layer is a resistive layer. In practical applications we often encounter the RCR line. Among the non-uniform RC lines linear and exponential lines are used. Generally the RC line has a spatial arrangement (see Fig. 4). Analysis of the spatial network is quite complicated, but feasible

There is a large number of the physical and technical processes described with partial differential equations of a parabolic type [1–7]. Searching for numerical solutions uses discretization of spatial variables [8]. Consequently, in place of the partial equation we get an ordinary differential equation, which can be modeled by an appropriate ladder system [3, 4, 9, 10], generally with a corresponding spatial network [11, 12].

Some difficulties arise in modeling of vibrating systems with distributed parameters with an infinite number of frequencies using finite dimensional ladder systems LC or RLC [4, 10, 12]. The LC ladder system has a finite number of

natural frequencies. It is known that stimulation of the distributed system with a signal of frequency, which has been omitted in the finite-dimensional approximation, can lead to the destruction of the system (resonance).

In the mathematical models of ladder systems there are tridiagonal Jacobi matrices [13–17], which in particular cases are Metzler matrices or oscillating matrices [14]. Therefore, some basic properties of such a matrix are presented in this work. These elements enable a reader to analyze other types of structures and ladder systems.

There is considerable literature on different types of ladder systems [9, 18–20]. The authors often emphasize the close relationship between ladder systems and distributed systems described by partial differential equations [9, 10]. The applications of RC ladder systems for analysis and modeling of microelectronic circuits [1, 21], supercapacitors [21–24], biological systems [7, 25], temperature distribution in the modeling of spatial structures [9] and in electricity transmission problems [26–29] are of particular interest.

In this work the dynamic properties characterized by the eigenvalues of the following structures spacious were given: integrated ladder RC, RCR, RRC and RC network RRCRR flat and spatial. Such structures has recently been used eg. for modeling of supercapacitors. The study also considered RCR ring systems and exponentially convergent RC. Most of the results obtained (see Secs. 4–9) is new comparing with results known in the existing literature.

The paper is organized as follows: in Sec. 2 spectral properties of tridiagonal matrices are considered. In Sec. 3 basic RC ladder structure was presented. In Sec. 4 we considered the RCR-uniform ladder network. In Sec. 5 the RCR-ring uniform ladder network is considered. In Sec. 6 the RRC and RRCR-uniform ladder networks are presented. In Sec. 7 the exponential RC-ladder network is considered. In Sec. 8 the RC flat network is analyzed whereas in Sec. 9 we analyze the RC-spatial network. Concluding remarks are given in Sec. 10.

*e-mail: wojciech.mitkowski@agh.edu.pl

2. Cyclic and tridiagonal Jacobi matrices

A special case of the cyclic Jacobi matrix is a tridiagonal Jacobi matrix. Tridiagonal matrices are naturally associated with the ladder systems whereas the cyclic Jacobi matrix is used in a description of ring ladder networks systems. For this reason, below we present the basic properties of the Jacobi matrices [15, p. 26 and 27].

We consider $n \times n$ real matrix denoted by B_n . For example, for $n = 5$ we have

$$B_5 = \begin{bmatrix} b_1 & c_1 & 0 & 0 & a_1 \\ a_2 & b_2 & c_2 & 0 & 0 \\ 0 & a_3 & b_3 & c_3 & 0 \\ 0 & 0 & a_4 & b_4 & c_4 \\ c_5 & 0 & 0 & a_5 & b_5 \end{bmatrix}. \quad (1)$$

Remark 1. If $a_1 c_n > 0$, $a_{i+1} c_i > 0$, $i = 1, 2, 3, \dots, n - 1$ and $a_1 \cdot a_2 \cdot \dots \cdot a_n = c_1 \cdot c_2 \cdot \dots \cdot c_n$, then B_n is called cyclic Jacobi matrix. Eigenvalues $\lambda_i(B_n)$ of B_n are real, but not necessarily single [15, p. 139].

Example 1. We consider $n \times n$ cyclic Jacobi matrix B_n with $b_i = b$, $a_i = c_i = 1$, given in following equality and denote by

$$JCYC(n; b) = \begin{bmatrix} b & 1 & 0 & \dots & 1 \\ 1 & b & 1 & \dots & 0 \\ 0 & 1 & b & \dots & 0 \\ \dots & \dots & \dots & \dots & \dots \\ 1 & 0 & 0 & \dots & b \end{bmatrix}, \quad (2)$$

where b is real number. The eigenvalues λ_k of cyclic matrix $JCYC(n; b)$ [15, p. 159] are given by

$$\lambda_k(JCYC(n; b)) = b + 2 \cos \varphi_k, \quad k = 1, 2, 3, \dots, n \quad (3)$$

where

$$\varphi_k = k2\pi/n. \quad (4)$$

Remark 2. If $a_1 = 0$, $c_n = 0$ and $a_{i+1} c_i > 0$ for $i = 1, 2, 3, \dots, n - 1$, then $A_n = B_n$ is following a $n \times n$ tridiagonal Jacobi matrix (shown for simplification for $n = 5$):

$$A_5 = \begin{bmatrix} b_1 & c_1 & 0 & 0 & 0 \\ a_2 & b_2 & c_2 & 0 & 0 \\ 0 & a_3 & b_3 & c_3 & 0 \\ 0 & 0 & a_4 & b_4 & c_4 \\ 0 & 0 & 0 & a_5 & b_5 \end{bmatrix}. \quad (5)$$

The tridiagonal real Jacobi matrix A_n has only single (distinct) real eigenvalues $\lambda_1, \dots, \lambda_n$ [15, p. 83, p. 104]. Thus, the matrix A_n is similar to the diagonal canonical Jordan form $J = \text{diag}(\lambda_1, \lambda_2, \dots, \lambda_n)$.

Remark 3. If $a_i = a$, $b_i = b$, $c_i = c$ and additionally $b_1 = b + y$, $b_n = b + z$. Let T be a $n \times n$ tridiagonal matrix given by

$$T(n; a, b, c, y, z) = \begin{bmatrix} b + y & c & \dots & 0 \\ a & b & c & \dots & 0 \\ 0 & a & b & \ddots & 0 \\ \dots & \dots & \ddots & \ddots & c \\ 0 & 0 & \dots & a & b + z \end{bmatrix}. \quad (6)$$

Then the determinant of $T(n; a, b, c, y, z)$ is given by [30, 15, p. 154]

$$\det T(n; a, b, c, y, z) = (\sqrt{ac})^n \frac{\sin(n+1)\varphi + \frac{y+z}{\sqrt{ac}} \sin \varphi + \frac{yz}{\sqrt{ac}} \sin(n-1)\varphi}{\sin \varphi}, \quad (7)$$

where φ is a complex number such that $b = 2 \cos \varphi$.

Example 2. For the special case that $y = z = 0$, the determinant of $T(n; a, b, c, 0, 0)$ is given by [30]

$$\det T(n; a, b, c, y, z) = \prod_{i=1}^n (b - 2\sqrt{ac} \cos \varphi_k), \quad (8)$$

$$\varphi_k = \frac{k\pi}{n+1}.$$

The eigenvalues λ_k of $T(n; a, b, c, 0, 0)$ we obtain from equation $\det T(n; a, \lambda - b, c, 0, 0) = 0$. Thus (see also ...)

$$\lambda_k = b + 2\sqrt{ac} \cos \varphi_k, \quad k = 1, 2, 3, \dots, n, \quad (9)$$

where

$$\varphi_k = k\pi/(n+1). \quad (10)$$

Let [19]

$$P = \sqrt{\frac{2}{n+1}} \begin{bmatrix} \sin \varphi_1 & \sin 2\varphi_1 & \dots & \sin n\varphi_1 \\ \sin \varphi_2 & \sin 2\varphi_2 & \dots & \sin n\varphi_2 \\ \dots & \dots & \dots & \dots \\ \sin \varphi_n & \sin 2\varphi_n & \dots & \sin n\varphi_n \end{bmatrix}, \quad (11)$$

where φ_k is given in (10). You can check that $P^2 = I$. Thus $P^{-1} = P$ and

$$PTP = \text{diag}(\lambda_1, \lambda_2, \dots, \lambda_n), \quad (12)$$

where λ_k is given in (9). In others words, the matrix $T(n; a, b, c, 0, 0)$ is diagonalizable.

3. Fundamental model of distributed RC network (RC-ladder network)

Consider an electric RC-ladder network shown for $n = 3$ in Fig. 1. The parameters of network $R_i > 0$ and $C_i > 0$ are known.

The system shown in Fig. 1 is described (for any n) by equations

$$\dot{x}_i(t) = a_i x_{i-1}(t) + b_i x_i(t) + c_i x_{i+1}(t), \quad (13)$$

where $i = 1, 2, 3, \dots, n$, $x_0(t) = u(t)$, $x_{n+1}(t) = 0$ and

$$a_i = 1/(R_i C_i), \quad c_i = 1/(R_{i+1} C_i), \quad (14)$$

$$b_i = -(a_i + c_i).$$

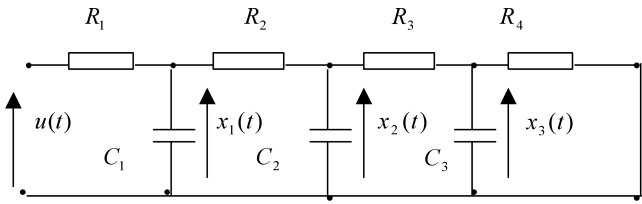
Fig. 1. RC-ladder network for $n = 3$

The RC-ladder system can be described by following matrix differential equation:

$$\dot{x}(t) = A_n x(t) + B u(t), \quad B^T = [1 \ 0 \ 0 \ \dots \ 0 \ 0], \quad (15)$$

$$x(t) = [x_1(t) \ \dots \ x_n(t)]^T,$$

where A_n is given (for $n = 5$) by (5) with parameters (24).

Remark 4. The matrix A_n is similar (see Remark 2) to the diagonal canonical Jordan form, that is to say that there exists P such that $P^{-1}A_n P = J = \text{diag}(\lambda_1, \lambda_2, \dots, \lambda_n)$. Additionally $\lambda_k \in [-m, 0)$, $k = 1, \dots, n$, $m = 2 \max_k(a_k + c_k)$, $a_k + c_k = (1/R_k + 1/R_{k+1})/C_k$ [31] i.e. the RC-ladder system is asymptotically stable.

Let $x(t) = Pz(t)$. Thus $z(t) = P^{-1}x(t)$ and from (25) we have

$$\dot{z}_k(t) = \lambda_k z_k(t) + w_k u(t). \quad (16)$$

The function $G(s)$ of the system (26) is given by

$$G(s) = \frac{w_k}{s - \lambda_k} = \frac{Z_k(s)}{U_k(s)}. \quad (17)$$

The unit-step response of the system (27) can be expressed as

$$y_k(t) = L^{-1}\{G(s)\} = w_k \exp(\lambda_k t). \quad (18)$$

Remark 5. Let $J(n; b) = T(n; 1, b, 1, 0, 0)$, where $T(n; a, b, c, y, z)$ is given by (6). Let $x_0(t) = u(t)$, $x_{n+1}(t) = 0$. If $R_i = R$, $C_i = C$ (see Fig. 1) then the system (13), (14) is called **RC-uniform ladder network**. The RC-uniform ladder system (13), (14) can be described by matrix equation

$$RC\dot{x}(t) = J(n; -2)x(t) + B u(t),$$

$$B^T = [1 \ 0 \ 0 \ \dots \ 0 \ 0], \quad (19)$$

$$x(t) = [x_1(t) \ \dots \ x_n(t)]^T.$$

The eigenvalues λ_k of the $n \times n$ matrix $J(n; b)$ are given by (9) with $a = c = 1$. Let $x(t) = Pz(t)$. Thus $z(t) = P^{-1}x(t)$ and from (19) we have equation (16) with

$$\lambda_k = -\frac{2}{RC}(1 - \cos \varphi_k) = -\frac{4}{RC} \sin^2 \frac{\varphi_k}{2},$$

$$w_k = \frac{1}{RC} \sqrt{\frac{2}{n+1}} \sin \varphi_k, \quad (20)$$

$$\varphi_k = \frac{k \pi}{n+1},$$

where $k = 1, 2, 3, \dots, n$.

Now we can consider other structures of RC-ladder networks. After presenting the basic properties of the (see Fig. 1)

RC circuit model with distributed parameters we analyze other structures, which will be reduced to the basic structure described with scalar differential equation (16).

4. RCR-uniform ladder network

Now we consider RCR-uniform ladder network. For $n = 3$ the RCR-ladder network is shown in Fig. 2.

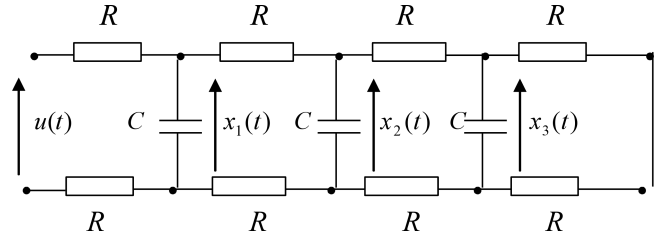
Fig. 2. RCR-uniform ladder network for $n = 3$

The RCR-uniform ladder network can be described by the following equation

$$2RC\dot{x}(t) = J(n; -2)x(t) + B u(t), \quad (21)$$

$$B^T = [1 \ 0 \ 0 \ \dots \ 0],$$

where $J(n; b) = T(n; 1, b, 1, 0, 0)$, where $T(n; a, b, c, y, z)$ is given by (6). The eigenvalues λ_k , $k = 1, 2, 3, \dots, n$, of the $n \times n$ matrix $J(n; b)$ are given by (9) with $a = c = 1$.

Let $x(t) = Pz(t)$, where P is given in (11), $\det P \neq 0$. Thus from (21) we have equation (16) with

$$\lambda_k = -\frac{1}{RC}(1 - \cos \varphi_k) = -\frac{2}{RC} \sin^2 \frac{\varphi_k}{2},$$

$$w_k = \frac{1}{2RC} \sqrt{\frac{2}{n+1}} \sin \varphi_k, \quad (22)$$

$$\varphi_k = \frac{k \pi}{n+1}$$

where $k = 1, 2, 3, \dots, n$. The system (21) is diagonalizable, i.e. system (21) can be broken down into n scalar systems given by (16) with parameters (22).

5. RCR-ring uniform ladder network

Consider the fundamental RC-ladder system (13) and let

$$x_0(t) = x_n(t), \quad x_{n+1}(t) = x_1(t) \quad (23)$$

and $R_{n+1} = R_1$.

In this case the system (13), (23) is called an electric RC-ring network.

If $R_i = R$, $C_i = C$, then the RCR-ring system (see Fig. 4 for $n = 6$) can be described by equation

$$2RC\dot{x}(t) = JCYC(n; -2)x(t), \quad (24)$$

where $x(t) = [x_1(t) \ x_2(t) \ \dots \ x_n(t)]^T$ and matrix $JCYC(n; b)$ is given in (2). The system given in (24) is diagonalizable (see eigenvalues of matrix $JCYC(n; b)$ given by (3), (4)).

The RCR-ring uniform ladder network for $n = 6$ is shown in Fig. 3.

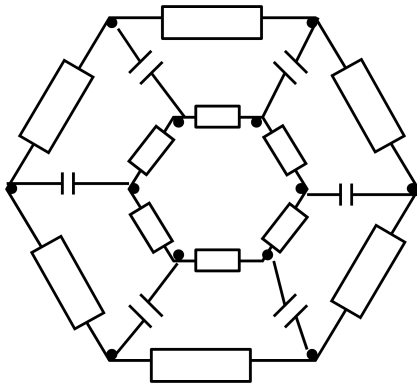

Fig. 3. RCR-ring uniform ladder network for $n = 6$

6. RRC and RRCR-uniform ladder network

In this section let us consider RRCr-ladder network (see Fig. 4 for $n = 3$). If $r = 0$, then the ladder network is called an electric RRC- uniform ladder network.

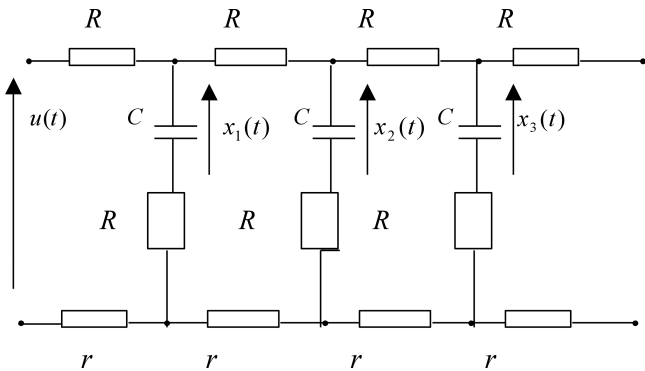

Fig. 4. RRCr-uniform ladder network for $n = 3$

The RRC-ladder network (see Fig. 4 with $r = 0$) can be described in general by equation

$$-RC J(n; -3) \dot{x}(t) = J(n; -2) x(t) + B u(t), \quad (25)$$

where $x(t) = [x_1(t) \ x_2(t) \ \dots \ x_n(t)]^T$, $B = [1 \ 0 \ \dots \ 0]^T$ and matrix $J(n; b) = T(n; 1, b, 1, 0, 0)$, where $T(n; a, b, c, y, z)$ is given by (6).

Remark 6. Consider the matrix $J(n; b) = T(n; 1, b, 1, 0, 0)$. Let e and g be a real numbers. Note that $J(n; e + g) = J(n; e) + gI$, where I is the identity matrix $n \times n$. Consequently $\lambda_k(J(n; e + g)) = e + g + 2 \cos \varphi_k$. Matrix $J(n; e + g) = J(n; e) + gI$ is diagonalizable by P given in (11).

The system (25) is diagonalizable [24] i.e. system (25) can be broken down into n scalar systems given by following equation:

$$RC s_k(-J(n; -3)) \dot{z}_k(t) = s_k(J(n; -2)) z_k(t) + \sqrt{\frac{2}{n+1}} \sin \varphi_k u(t), \quad (26)$$

where $k = 1, 2, 3, \dots, n$ and $x(t) = Pz(t)$, $z(t) = Px(t)$, P is given in (11). The eigenvalues s_k of the $n \times n$ matrix

$J(n; b)$ are given by (9), (10) with $a = c = 1$. Thus we have (see Remark 6)

$$s_k(-J(n; -3)) = 1 + 4 \sin^2 \frac{\varphi_k}{2} > 0, \quad (27)$$

$$s_k(J(n; -2)) = -4 \sin^2 \frac{\varphi_k}{2} < 0.$$

From (26) and (30) we have (see (16))

$$\dot{z}_k(t) = \lambda_k z_k(t) + w_k u(t), \quad (28)$$

$$k = 1, 2, 3, \dots, n,$$

where $\lambda_k = \{s_k(J(n; -2))/s_k(J(n; -3))\}/RC$,

$$\lambda_k = -\frac{4 \sin^2 \frac{\varphi_k}{2}}{RC (1 + 4 \sin^2 \frac{\varphi_k}{2})}, \quad (29)$$

$$w_k = \frac{\sqrt{\frac{2}{n+1}} \sin \varphi_k}{RC (1 + 4 \sin^2 \frac{\varphi_k}{2})}.$$

If $r = R$ (see Fig. 4), then the ladder network is called RRCR- uniform ladder network. The RRCR-ladder network can be described by equation

$$-RC J(n; -4) \dot{x}(t) = J(n; -2) x(t) + B u(t). \quad (30)$$

The system (30) is diagonalizable, i.e. system (30) can be broken down into n scalar systems given by following equation:

$$RC s_k(-J(n; -4)) \dot{z}_k(t) = s_k(J(n; -2)) z_k(t) + \sqrt{\frac{2}{n+1}} \sin \varphi_k u(t), \quad (31)$$

where $k = 1, 2, 3, \dots, n$ and the eigenvalues s_k of $J(n; b)$ are given by (9), (10) with $a = c = 1$:

$$s_k(-J(n; -4)) = 2 + 4 \sin^2 \frac{\varphi_k}{2} > 0, \quad (32)$$

$$s_k(J(n; -2)) = -4 \sin^2 \frac{\varphi_k}{2} < 0.$$

From (31) and (32) we have (see (16))

$$\dot{z}_k(t) = \lambda_k z_k(t) + w_k u(t), \quad (33)$$

$$k = 1, 2, 3, \dots, n,$$

where

$$\lambda_k = \frac{s_k(J(n; -2))}{RC s_k(J(n; -3))}, \quad (34)$$

$$w_k = \frac{\sqrt{2/(n+1)} \sin \varphi_k}{RC s_k(J(n; -3))}.$$

7. Exponential RC-ladder network

Consider the long line [2, p. 22 and 46], [10] of heterogeneous parameters R and C . Let the length of the line is equal to 1, $z \in (0, 1)$. Let $h = 1/(n + 1)$ be a step discretization variable $z \in (0, 1)$. Heterogeneous exponentially converges transmission line has the following parameters given by formulas: $R(z) = R \exp(az)$ and $C(z) = C \exp(-az)$. In this

case the suitable RC-ladder system similar to that shown in Fig. 1 with parameters

$$R_i = k^i R, \quad C_i = k^{-i} C, \quad k > 0. \quad (35)$$

Systems (15), (35) are called the exponential RC-ladder network. A state matrix of systems (15), (35) is given by

$$A_n = \frac{1}{RC} T(n; 1, -(1 + 1/k), 1/k, 0, 0) = \frac{1}{RC} \begin{bmatrix} -(1 + 1/k) & 1/k & 0 & \dots & 0 \\ 1 & -(1 + 1/k) & 1/k & \dots & 0 \\ \vdots & \ddots & \ddots & \ddots & \vdots \\ 0 & \dots & 1 & -(1 + 1/k) & 1/k \\ 0 & \dots & 0 & 1 & -(1 + 1/k) \end{bmatrix}, \quad (36)$$

where $T(n; a, b, c, y, z)$ is given by (6). Eigenvalues of matrix (36) are given by

$$\lambda_k = -\frac{1}{RC} \left(1 + \frac{1}{k} - 2\sqrt{\frac{1}{k}} \cos \varphi_k \right), \quad (37)$$

where $k = 1, 2, 3, \dots, n$, φ_k is given in (10). It is evident that the exponential RC-ladder network may be represented in the form (16).

8. RC-plane network

Detail of the RC-plane network in R^2 is shown in Fig. 5. The scheme of a flat RC-network is shown in Fig. 6. The RC-plane network can be described by equation

$$RC \dot{x}_{i,k} = x_{i,k-1} - 2x_{i,k} + x_{i,k+1} + x_{i,k+1} + x_{i-1,k} - 2x_{i,k} + x_{i+1,k}, \quad (38)$$

where $x_{i,k}$ is the voltage on the capacitance C associated with the node (i, k) , $i = 1, 2, 3, \dots, m$ and $k = 1, 2, 3, \dots, n$.

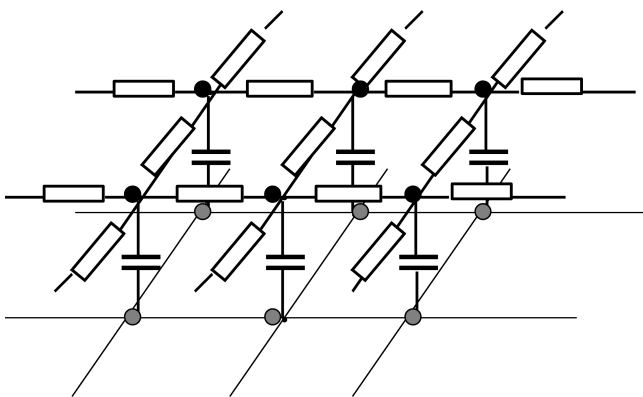

Fig. 5. RC- plane network

The system (38) can be described by equation

$$RC \dot{x}(t) = JBLOC [m; J(n; b)] x(t) + Bu(t). \quad (39)$$

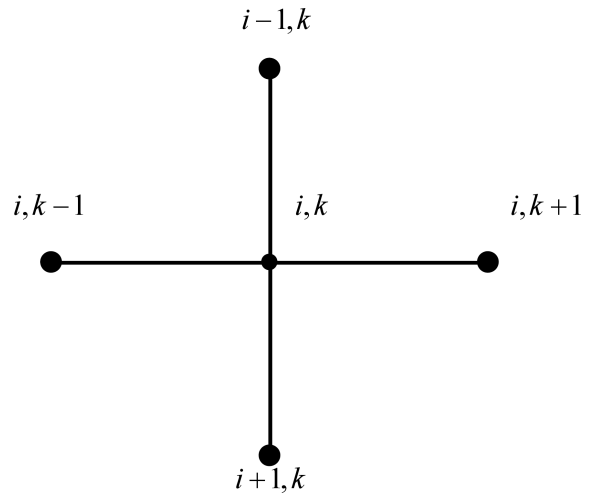

Fig. 6. Scheme a flat RC-network

A method of power supply determines the matrix B . The matrix B is dependent on the boundary control. Real block-matrix $JBLOC [m; J(n; b)]$ for $m = 2, n = 3, b = -4$ is given by equation

$$JBLOC [2; J(3; -4)] = \begin{bmatrix} -4 & 1 & 0 & 1 & 0 & 0 \\ 1 & -4 & 1 & 0 & 1 & 0 \\ 0 & 1 & -4 & 0 & 0 & 1 \\ 1 & 0 & 0 & -4 & 1 & 0 \\ 0 & 1 & 0 & 1 & -4 & 1 \\ 0 & 0 & 1 & 0 & 1 & -4 \end{bmatrix} = \begin{bmatrix} J(3; -4) & I_{3 \times 3} \\ I_{3 \times 3} & J(3; -4) \end{bmatrix}. \quad (40)$$

The eigenvalues $s_{i,k}$ of $JBLOC [m; J(n; b)]$ given by formula [11]

$$s_{i,k} = b + 2 (\cos \psi_i + \cos \varphi_k), \quad (41)$$

where $k = 1, 2, 3, \dots, n$ and $i = 1, 2, 3, \dots, m$

$$\varphi_k = k\pi / (n + 1), \quad \psi_i = i\pi / (m + 1). \quad (42)$$

Formulas for eigenvectors of the block-matrix $JBLOC [m; J(n; b)]$ are given in [11].

Example 2. Consider the matrix (40). Let

$$V = \begin{bmatrix} -0.3536 & 0.5000 & 0.3536 & 0.3536 & -0.5000 & 0.3536 \\ 0.5000 & 0.0000 & -0.5000 & 0.5000 & 0.0000 & 0.5000 \\ -0.3536 & -0.5000 & 0.3536 & 0.3536 & 0.5000 & 0.3536 \\ 0.3536 & -0.5000 & 0.3536 & -0.3536 & -0.5000 & 0.3536 \\ -0.5000 & 0.0000 & -0.5000 & -0.5000 & 0.0000 & 0.5000 \\ 0.3536 & 0.5000 & 0.3536 & -0.3536 & 0.5000 & 0.3536 \end{bmatrix}. \quad (43)$$

Thus

$$V^T JBLOC [2; J(3; -4)] V = \text{diag} (-6.4142, -5.0000, -4.4142, -3.5858, -3.0000, -1.5858).$$

The system (39) is diagonalizable (see eigenvalues of block-matrix $JBLOC [m; J(n; b)]$ given in Eq. (41). The

eigenvalues of $JBLOC [m; J(n; b)]$, not necessarily single. This is important for the study of controllability of system (39) – see for example [32–34].

9. RC-spatial network

The scheme of a spatial three-dimensional RC-network is shown in Fig. 7. The RC-spatial network can be described by equation

$$RC \dot{x}_{j,i,k} = x_{j,i,k-1} - 2x_{j,i,k} + x_{j,i,k+1} + x_{j,i-1,k} - 2x_{j,i,k} + x_{j,i+1,k} + x_{j-1,i,k} - 2x_{j,i,k} + x_{j+1,i,k}, \quad (44)$$

where $x_{j,i,k}$ is the voltage on the capacitance C associated with the node (j, i, k) , which spans the junction with the common duct without impedance, $i = 1, 2, 3, \dots, m$, $k = 1, 2, 3, \dots, n$ and $j = 1, 2, 3, \dots, l$ [11, 12]. R is the resistance value, which is located between any two adjacent nodes. Edge nodes – the nodes to which any index is equal to zero or one of the numbers: $l + 1, m + 1, n + 1$. Edge nodes are powered by a suitable control voltage.

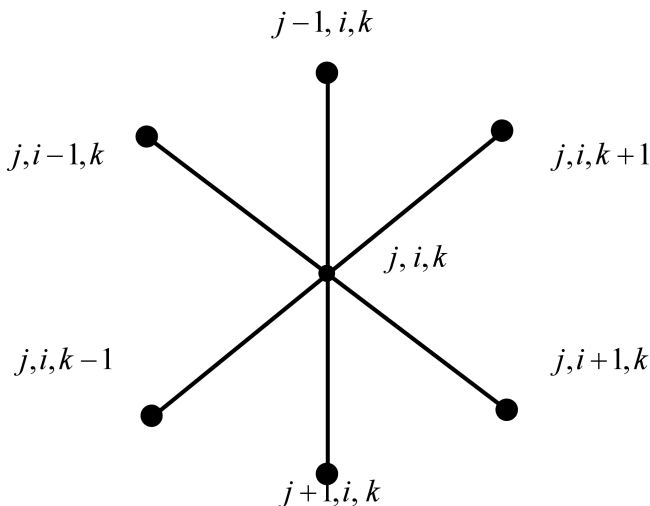

Fig. 7. Scheme a spatial three-dimensional RC-network

The formula (44) creates a corresponding state big-block-matrix denote by

$$JBIGBLOCK \{l; JBLOC [m; J(n; b)]\}.$$

Dimension of quadratic matrix

$$JBIGBLOCK \{l; JBLOC [m; J(n; b)]\}$$

is $l \cdot m \cdot n$. Thus the system (42) can be described by equation

$$RC \dot{x}(t) = JBIGBLOC \{l; JBLOC [m; J(n; b)]\} x(t) + Bu(t). \quad (45)$$

The matrix B is dependent on the boundary control. The eigenvalues $s_{j,i,k}$ of big-block-matrix $JBIGBLOCK \{l; JBLOC [m; J(n; b)]\}$ are given in by formula [11, 12]

$$s_{j,i,k} = b + 2(\cos \theta_j + \cos \psi_i + \cos \varphi_k), \quad (46)$$

where $k = 1, 2, 3, \dots, n$, $i = 1, 2, 3, \dots, m$, $j = 1, 2, 3, \dots, l$ and

$$\varphi_k = k\pi/(n+1), \quad \psi_i = i\pi/(m+1), \quad (47)$$

$$\theta_j = j\pi/(l+1).$$

Formulas for eigenvectors of the big-block-matrix $JBIGBLOCK \{l; JBLOC [m; J(n; b)]\}$ are given in the paper [11].

10. Conclusions and remarks

- In this paper the dynamic properties characterized by the eigenvalues of the following structures are considered: the ladder systems RC, RCR, RRC, RRCRR and a flat and spatial RC networks. The study also considered an exponentially convergent ladder network and RCR ring systems.
- We proved that the analytical approach to complex RC ladder systems is possible. The RC structures can be transformed to (16).
- Using (7) it is possible to find analytical formulas for non-uniform systems (nonuniformity at the ends of the line or system with different boundary conditions).
- The ladder and ring networks can be applied in approximation of processes such as: hot mill in metallurgy [4], long transmission line [9], multicomponent rectification in distillation column, or when we consider an approximation of some distributed parameter systems [3, 6, 8].
- Analyses of RC structures shown in Figs. 2–5 (see Secs. 4–9) are original and new compared with the results existing in literature. Such structures are used for example in supercapacitors modeling [21–24].
- The considerations can be extended to the electric fractional ladder networks too. The problems associated with the analysis of fractional systems can be found in [22, 23, 35–39].

Acknowledgements. This work was supported by the AGH (Poland) – the project No 11.11.120.817.

REFERENCES

- [1] M. Janicki, J. Banaszczyk, B. Vermeersch, G. De Mey, and A. Napieralski, “Generation of reduced thermal models of electronic systems from time constant spectra of transient temperature responses”, *Microelectronics Reliability* 51 (8), 1351–1355 (2011).
- [2] J. Roszkiewicz, *Distributed RC Systems*, WKiŁ, Warszawa, 1972, (in Polish).
- [3] A. Auer, *Analog Modeling of Distributed Processes*, MM PWN, Warszawa, 1976, (in Polish).
- [4] A.G. Butkowsky, *Optimal Control Systems with Distributed Parameters*, Moskwa, 1965, (in Russian).
- [5] K. Deng, P. Barooah, P.G. Mehta, and S.P. Meyn, “Building thermal model reduction via aggregation of states”, *American Control Conf.* 1, 5118–5123 (2010).
- [6] E. Kaćki, *Partial Differential Equations in Physics and Engineering*. WNT, Warszawa, 1992, (in Polish).
- [7] R. Marshall, “Modeling DNA/RNA strings using resistor–capacitor (rc) ladder networks”, *Computer J.* 53 (6), 644–660 (2009).

Finite-dimensional approximations of distributed RC networks

- [8] S.G. Michlin and C.L. Smolicki, *Approximate Methods of Solving Differential and Integral Equations*, PWN, Warszawa, 1970, (in Polish).
- [9] T. Cholewicki, *An Electrical Long Lines and Nonuniform Ladder Networks*, PWN, Warszawa, 1974, (in Polish).
- [10] W. Mitkowski, "Approximation of an infinite line by a ladder network", *Archives Electrotechnics* 25 (4), 943–953 (1976), (in Polish).
- [11] W. Mitkowski, "Uniform spatial networks RC", *Archives Electrotechnics* 22 (2), 397–405 (1973), (in Polish).
- [12] W. Mitkowski, "Uniform spatial networks RC (RL and GC type)", *Proc. SSCT 74 2*, 73–76 (1974).
- [13] R. Bellman, *Introduction to Matrix Analysis*, McGraw-Hill, New York, 1960.
- [14] F.R. Gantmaher, *Theory of Matrix*, 4 ed., Nauka, Moskwa, 1988, (in Russian).
- [15] W.P. Ilin and Yu.I. Kuznyetsov, *Tridiagonal Matrices and Their Applications*, Nauka, Moskwa, 1985, (in Russian).
- [16] P. Lancaster, *Theory of Matrix*, Academic Press, New York, 1969.
- [17] A. Turowicz, *Theory of Matrix*, 6 ed., AGH, Kraków, 2005, (in Polish).
- [18] Z. Bubnicki, "Input impedance and transfer function of a ladder network", *IEEE Trans. on Circuit Theory* 10, 286–287 (1963).
- [19] W. Mitkowski, Synthesis of RC-ladder network, *Bull. Pol. Ac.: Tech.* 42, 33–37 (1994).
- [20] M.N.S. Swamy, "Network properties of a pair of generalized polynomials", *Circuits and Systems, IEEE Proc.* 1, 114–117 (1998).
- [21] G. Sarwas, "Modelling and control of systems with ultracapacitors using fractional order calculus", *Doctoral Thesis*, pp. 1–102, Warsaw University of Technology, Faculty of Electrical Engineering, Warszawa, 2012.
- [22] R. Caponetto, G. Dongola, L. Fortuna, and I. Petráš, *Fractional Order Systems: Modeling and Control Applications*, World Scientific, London, 2010.
- [23] A. Dzielinski, G. Sarwas, and D. Sierociuk "Comparison and validation of integer and fractional order ultracapacitor models", *Advances in Difference Equations* 1, 11–23, (2011).
- [24] W. Mitkowski and P. Skruch, "Fractional-order models of the supercapacitors in the form of RC ladder networks", *Bull. Pol. Ac.: Tech.* 61 (3), 581–587 (2013).
- [25] W. Mitkowski, "Dynamic properties of chain systems with applications to biological models", *Archives of Control Sciences* 9 (XLV), 123–131 (1999).
- [26] M. Alioto, G. Palumbo, and M. Poli, "An approach to energy consumption modeling in RC ladder circuits", in *Integrated Circuit Design. Power and Timing Modeling, Optimization and Simulation Lecture Notes in Computer Science*, vol. 2451, pp. 239–246, Springer, Berlin, 2002.
- [27] M. Alioto, G. Palumbo, and M. Poli, "Evaluation of energy consumption in RC ladder circuits driven by a ramp input", *IEEE Trans. on Very Large Scale Integration (VLSI) Systems* 12 (10), 1094–1107 (2004).
- [28] J. Baranowski and W. Mitkowski, "Semi-analytical methods for optimal energy transfer in RC ladder networks", *Przegląd Elektrotechniczny (Electrical Review)* 88 (9a), 250–254 (2012).
- [29] W. Mitkowski, "Remarks about energy transfer in an RC ladder network", *Int. J. Appl. Math. Comput. Sci.* 13 (2), 193–198 (2003).
- [30] J. Cheng and T. Berger, "On minimal eigenvalues of a class of tridiagonal matrices", *IEEE Trans. on Information Theory* 55 (11), 5024–5031 (2009).
- [31] W. Mitkowski, "Remarks on stability of positive linear systems", *Control and Cybernetics* 29 (1), 295–304 (2000).
- [32] J. Klamka, *Controllability of Dynamic Systems*, PWN, Warszawa, 1990, (in Polish).
- [33] J. Klamka, "Controllability of Dynamical Systems", *Matematyka Stosowana* 9, 57–75 (2008).
- [34] J. Klamka, "Constrained approximate controllability", *IEEE Trans. on Automatic Control* 45, 1745–1749 (2000).
- [35] A. Djouambi, A. Charef, and A. Voda Besançon, "Optimal approximation, simulation and analog realization of the fundamental fractional order transfer function", *Int. J. Appl. Math. Comput. Sci.* 17 (4), 455–462 (2007).
- [36] T. Kaczorek, *Selected Problems in Fractional Systems Theory*, Springer-Verlag, Berlin, 2011.
- [37] T. Kaczorek and Ł. Sajewski, *Realization Problem for Positive and Fractional Systems*, Printing House of Białystok University of Technology, Białystok, 2013.
- [38] J. Klamka, "Controllability and minimum energy control problem of fractional discrete-time systems", in *New Trends in Nanotechnology and Fractional Calculus*, eds. D. Baleanu, Z.B. Guvenc and J.A. Tenreiro Machado, pp. 503–509, Springer-Verlag, New York, 2010.
- [39] J. Klamka, "Local controllability of fractional discrete-time nonlinear systems with delay in control", in: *Advances in Control Theory and Automation*, eds. M. Busłowicz and K. Malinowski, pp. 25–34, Printing House of Białystok University of Technology, Białystok, 2012.