

A. MILENIN\*, P. KUSTRA\*, D. BYRSKA-WÓJCIK\*

## THE PHYSICAL AND NUMERICAL MESOSCALE MODELING OF COLD WIRE DRAWING PROCESS OF HARDLY DEFORMABLE BIOCOMPATIBLE MAGNESIUM ALLOYS

### FIZYCZNE I NUMERYCZNE MODELOWANIE W MEZO SKALI PROCESU CIĄNIENIA NA ZIMNO TRUDNO ODKSZTAŁCALNYCH STOPÓW MAGNEZU O PODWYŻSZONEJ BIOZGODNOŚCI

The problem of determination of the cold low diameter wire (diameter less than 0.1mm) drawing process parameters for hardly deformable biocompatible magnesium alloys by using the mathematical mesoscale model is described in the paper. The originality of the considered alloys (MgCa0.8, Ax30) is the intergranular fracture mechanism associated with small strains (0.07-0.09). In previous authors works it was proven that the material state directly before appearance of the microcracks is in the optimal state from the point of view of the recovery of the plasticity by annealing. The forecasting of this material state in drawing process requires the development of the model of intergranular fracture initiation and using this model in two cases:

- modeling of the in-situ tests, what allows calibrating and validating of the model;
- modeling of the drawing process, what allows optimizing of the drawing parameters.

A new model of the microcracks initiation in mesoscale using the boundary element method is proposed. The in-situ tests, which allowed observing the microstructure evolution during deformation, are used for the calibration and validation purpose. The model was implemented into self-developed FE software Drawing2d, which is dedicated to the drawing process. The results of mesoscale simulation were verified by the experimental drawing process of 0.07 mm diameter wires according to developed technology. It was shown by analysis of microstructure that the model allows forecasting the microcracks initiation during the wire drawing process.

*Keywords:* MgCa0.8, Ax30, magnesium alloys, drawing process, fracture, FEM, BEM, mesoscale

W artykule rozpatrzono problem wyznaczenia parametrów ciągnięcia na zimno cienkich drutów (o średnicach mniejszych 0.1 mm) z nisko plastycznych stopów magnezu za pomocą matematycznego modelu w skali mezo. Osobliwością utraty spójności rozpatrywanych stopów (MgCa0.8, Ax30) jest dominujący mechanizm pęknięcia po granicach ziaren oraz powstawanie mikropęknięć przy małych odkształceniach (rzędu 0.07-0.09). W poprzednich pracach Autorów [1] udowodniono, że stan materiału bezpośrednio przed powstaniem mikropęknięć jest optymalny z punktu widzenia odnawiania plastyczności w procesie wyżarzania. Prognozowanie takiego stanu materiału w procesie ciągnięcia wymaga opracowania modelu powstawania mikropęknięć po granicach ziaren i wykorzystania tego modelu w dwóch trybach:

- modelowanie testów in-situ, co pozwala na kalibrację i walidację modelu;
- modelowanie procesu ciągnięcia, co pozwala na optymalizację jego parametrów.

Zaproponowano nowy model powstawania mikropęknięć w skali mezo, oparty o metodę elementów brzegowych. Do kalibracji i walidacji modelu wykorzystano badan in-situ, pozwalające na bezpośrednią obserwację mikrostruktury podczas odkształcenia. Opracowany model zaimplementowano do Autorskiego programu MES Drawing2d dedykowanemu procesowi ciągnięcia. Wyniki symulacji w skali mezo zweryfikowano na podstawie eksperymentalnego ciągnięcia drutów o małych średnicach (do 0.07 mm) zgodnego z opracowaną technologią. Na podstawie analizy mikrostruktury wykazano, że opracowany model pozwala przewidywać powstawanie mikropęknięć w procesie ciągnięcia.

## 1. Introduction

Magnesium alloys which have high biocompatibility and solubility in the human body can be used to produce a new generation of surgical sutures [1-3]. Typically, these alloys contain lithium and calcium elements.

Drawback of these alloys is a low technological ductility in cold forming. As it was shown in the previous works [4-5], formability of these alloys during cyclic processes, based on a combination of cold deformation and annealing, is significantly lower than for most common magnesium alloys. The reason of this is presented

\* AGH UNIVERSITY OF SCIENCE AND TECHNOLOGY, DEPARTMENT OF APPLIED COMPUTER SCIENCE AND MODELLING, 30-059 KRAKÓW, 30 MICKIEWICZA AV., POLAND

in [6]. In studied alloys, during cold deformation there are hairline fractures on the grain boundaries long before the fracture in the macro scale occurs. These cracks considerably obstruct plasticity restoration due to annealing while the alloys may have characteristics of plasticity in the standard tests for fracture, comparable with known Mg alloys.

One way to solve the problem is proposed in the works [7-9]. It is based on drawing in a hot die. Those studies shown that this method is effective for wire with diameter bigger than 0.1 mm. Obtaining of a small diameter wire from Mg alloys is difficult because of the strong sensitivity of the process to drawing speed. Another disadvantage is that lubricant cannot be used in case of medicine application. Thus the solution of listed problems requires in-depth study of cold-drawn of these alloys.

This observations lead to the conclusion that a numerical model of the wire drawing process, especially of magnesium alloys, should take into account the mechanism of fracture on the grain boundaries. Moreover, a very important factor in optimizing the drawing process is the occurrence of the first micro-crack [10].

The aim of this work is to determine the schedule (forming diagram) of the cold drawing of thin wires (diameter less than 0.1 mm) with the help of a multi scale modeling of cold wire drawing process and experimental validation of the obtained results.

## 2. Mechanism of deformation and fracture

As a material for the study MgCa08 (0.8% Ca 99.2%Mg) and its modification Ax30 (0.8%Ca, 3.0%Al, 96.2% Mg) were selected. Technique research of fracture mechanism based on tension sample in vacuum chamber of a microscope was performed. Microstructure evolution and fracture on grain boundaries during tension and shearing are being monitored.

The experiment is described in detail in the works [6, 10] and it is shown that these alloys, unlike typical magnesium alloys, fracture mainly on grain boundaries. Therefore long before the moment of fracture in macro scale in the sample appears porosity.

The deformation process will be considered on three levels. The first level corresponds to the deformation of the sample at the macro scale. At this level, the appearance of damage on grain boundaries will be characterized by the porosity of the sample (Fig. 1,a). The next level corresponds to the consideration of the grain boundaries and the fracture process at these boundaries (Fig. 1,b). Fracture processes in this case were considered as simplified modeling of deformation within the grains. The scale of the model in this case will be called

as mesoscopic (meso) scale. The third level corresponds to deformation inside the grains taking into account the orientation of crystal grid, slip bands and possibility of twinning Fig. 1,c.

Experimental studies [6, 10] showed that an intergranular fracture mechanism is mainly observed in the considered alloy. For this reason, in this paper only the models in the -macro and -meso scales are examined. An occurrence of porosity for alloy MgCa08 is shown in Fig. 1 in macro scale (Fig. 1,a), meso scale (Fig. 1,b) and micro scale (Fig. 1,c).

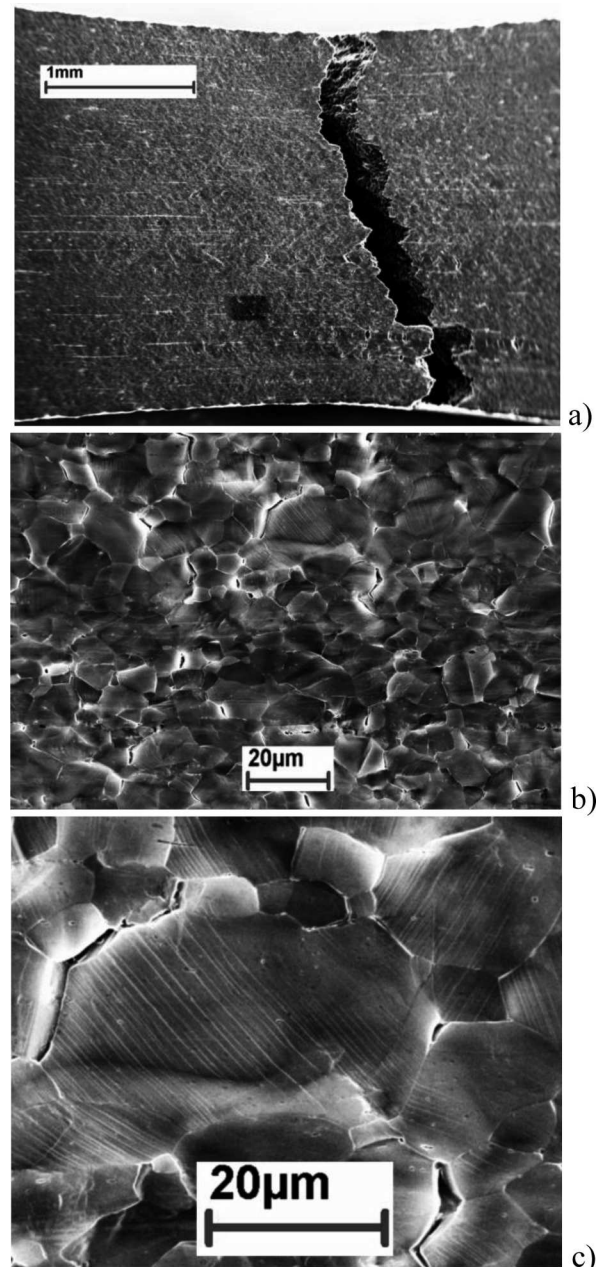

Fig. 1. The emergence of cracks during tensile strength of alloy MgCa08: a) on the surface of the sample in macro scale, b) the same in meso scale, c) the same in micro scale

Paper [6] shows that if the deformation on the current passes does not result in appearance of micro cracks (there was no porosity) subsequent annealing allows restoring of plasticity. Otherwise, the effectiveness of annealing is significantly reduced and a high degree of deformation in multi pass process is impossible.

On Fig. 2 the change of porosity in center of sample during tensile test of MgCa08 and Ax30 is shown. For comparison, it also shows data for alloy Az80 used in industry. The Fig. 2 shows that in these alloys cracks in meso scale appear much earlier than in the typical magnesium alloy AZ80. Thus, the occurrence of porosity in the early stages of deformation is the fundamental difference between considered alloys and known magnesium alloys. It follows from this that the development of the drawing schedule should be made in such a way that in every pass the occurrence of porosity is not fulfilled. To solve this problem a multi scale model of wire drawing process was proposed [6, 11]. For modeling fracture processes in meso scale modified boundary element method (BEM) was used, which allows simulating the fracture on grain boundaries. Algorithm based on the BEM model of inclusion in deformable matrix, which is presented in the work [12] was used.

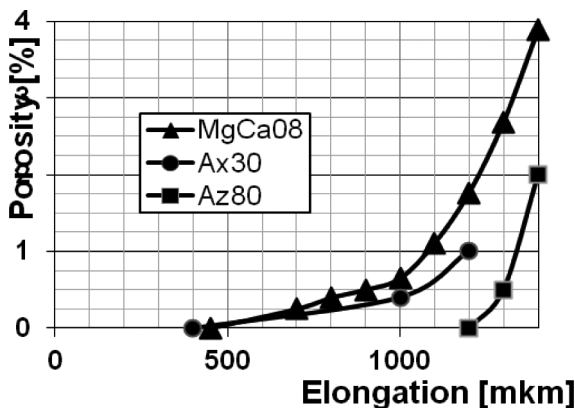

Fig. 2. Porosity dependence on absolute elongation of sample

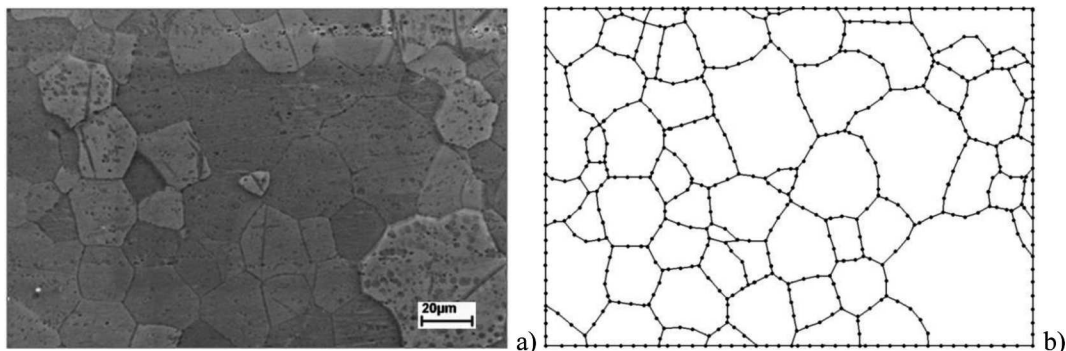

Fig. 3. Photo of microstructure (a) and BEM mesh (b)

### 3. Meso-scale mathematical model of drawing

Numerical model of drawing is based on finite element method and described in paper [13]. The digital representation of the microstructure in proposed BEM code is considered as a two-dimensional representative volume element (RVE) which is divided into lattice of grains (Fig. 3). To obtain a digital representation of the microstructure computer program described in the paper [14] was used. The model at the meso-scale includes the BEM mesh generation based on images of a part of real microstructure and numerical solution at the meso-scale level.

The crystallographic orientation is included in the developed program by a random parameter  $k$ , which refers to change of elastic-plastic properties due to the various orientations of grains.

The effective plastic modulus of the material for each grain is calculated as follows:

$$E_{eff} = k \frac{\bar{\sigma}}{\Delta\bar{\epsilon}} \quad (1)$$

where:  $k$  is the random parameter,  $\Delta\bar{\epsilon}$  – increment of mean equivalent strain in grain;  $\bar{\sigma}$  – yield stress of material in grain.

The Saint-Venant-Levy-Mises theory is used for relation between stresses and increments of strains for plastic deformation:

$$\sigma_{ij} = \delta_{ij}\sigma_0 + \frac{2\bar{\sigma}}{3\Delta\bar{\epsilon}}\Delta\epsilon_{ij} \quad (2)$$

where  $\delta_{ij}$  – the Kronecker delta,  $\sigma_0$  – the mean stress,  $\Delta\epsilon_{ij}$  – the increment of strain components.

Solution of boundary problem is based on the Kelvin fundamental solution [15] for the two-dimensional problem and incompressible material. The solution of boundary problem and fracture criteria are described in detail in previous works [6,10].

The proposed criteria of crack initiation are based on the theory by L. M. Kachanov and Y. N. Rabotnov [16]. This theory was successfully used in [17] for modeling of grain boundary cracking in the case of the deformation of the polycrystals, which fracture at the grain boundaries. This model was modified in [6] to describe the crack initiation at the grain boundary:

$$D = \int_0^{\tau} \dot{D} d\tau = 1 \quad (3)$$

$$\dot{D} = b_1 \left( \frac{\sigma_{eq}}{E} \right)^{b_2} (1 - D)^{b_3} \quad (4)$$

$$\sigma_{eq} = \sqrt{\sigma_n^2 + b_0 \sigma_s^2} \quad (5)$$

where:  $D$  – damage parameter;  $E$  – Young module;  $\sigma_n$  – tensile (positive) component of normal stress at the boundary between two grains;  $\sigma_s$  – shear stress at the boundary between two grains;  $b_0$ - $b_3$  – empirical coefficients.

In the developed model, the crack initiation is allowed only for the internal boundaries. The outer boundaries of the domains were assigned to boundary conditions, and in spite of a possible fulfillment of condition, they cannot be damaged (3).

The determination of empirical parameter of fracture model at the meso-scale is based on inverse analysis of experimental data. The purpose of this analysis is to minimize the difference between the empirical and calculated moment of crack initiation and empirical and calculated porosity in meso-scale of sample during deformation [11].

As a result of experimental data processing, shown in Fig. 2 for alloy Ax30 received the following coefficients of equations (4) and (5):  $b_0 = 0.02$ ,  $b_1 = 0.43$ ,  $b_2 = 0.30$ ,  $b_3 = -0.50$ .

#### 4. Multi-scale modelling of two regime of drawing

For the purpose of validation proposed techniques two variants of schedule of wire drawing was proposed:

variant 1: 0.1->0.0955->0.0912->0.087->0.0831->0.0794->0.0758 ... (elongation per pass 1.096);  
 variant 2: 0.162->0.147->0.135->0.123->0.112 ... (elongation per pass 1.20).

Die angle in each pass was  $5^\circ$ . Speed of drawing was 10 mm/s and was chosen in such a way that could enable annealing in a furnace, installed before the device for drawing. All passages in each variant were geometrically similar, that is the reason why for calculated results of stress and strain all passageways are close. Therefore, only simulation of first passage for each variant was performed.

Fig. 4 shows the results of simulation of the first pass for variant 1: triaxiality factor  $\sigma_0/\bar{\sigma}$  (Fig. 4,a),  $\sigma_x$  (Fig. 4,b) and equivalent strain  $\bar{\epsilon}$  (Fig. 4,c). Analogical data for variant 2 are presented on Fig. 5. The presented data show that stresses and strains in variants 1 and 2 are significantly different. From the point of view of experience of drawing of magnesium alloys and based on the results of the simulation in macro scale, the variant 2 is preferred, because in this case deformation is more homogeneous and value of tensile stresses is lower [18]. However, this refers to alloy (AZ31) without high propensity to meso fracture in the early stages of deformation. Thus, if the result of the experiment show, that preferable is variant 1, this may be the proof of theoretical conclusions about the major impact of meso cracks on technological plasticity.

Fig. 6 shows the distribution of strain parallel to the direction of drawing and vertical stresses along the centre line of the zone of deformation (this line is shown on Fig. 4 and 5). These parameters are used as boundary conditions for the simulation of deformation microstructure in meso scale. Results of simulation in meso scale are shown on Fig. 7-9. As can be seen from the results, in the variant 1 there are no cracks on the border of grains. The maximum value of the parameter  $D$  for passage amounted to 0.85 (Fig. 9,a). However in variant 2, there has been the emergence of meso cracks (Fig. 7,b) and values of  $D$  on some boundaries are 1.0. This suggests that, in this mode, ductility restoration of alloy after processing will not be possible and number of passes before the fracture of the wire will be small.

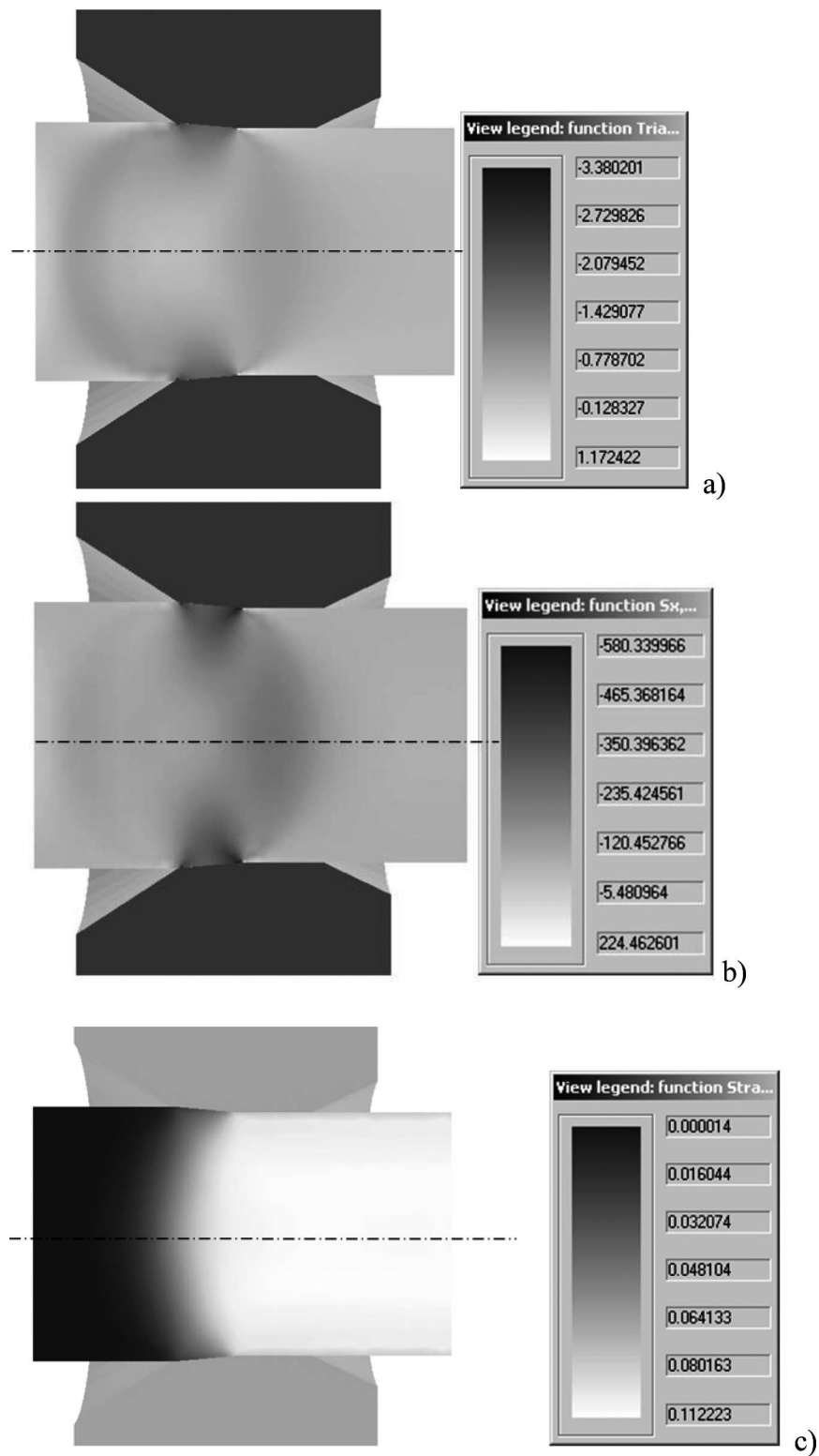

Fig. 4. Results of simulation of the first pass for variant 1: triaxiality factor  $\sigma_0/\bar{\sigma}$  (a),  $\sigma_x$ (b) and  $\bar{\epsilon}$  (c)

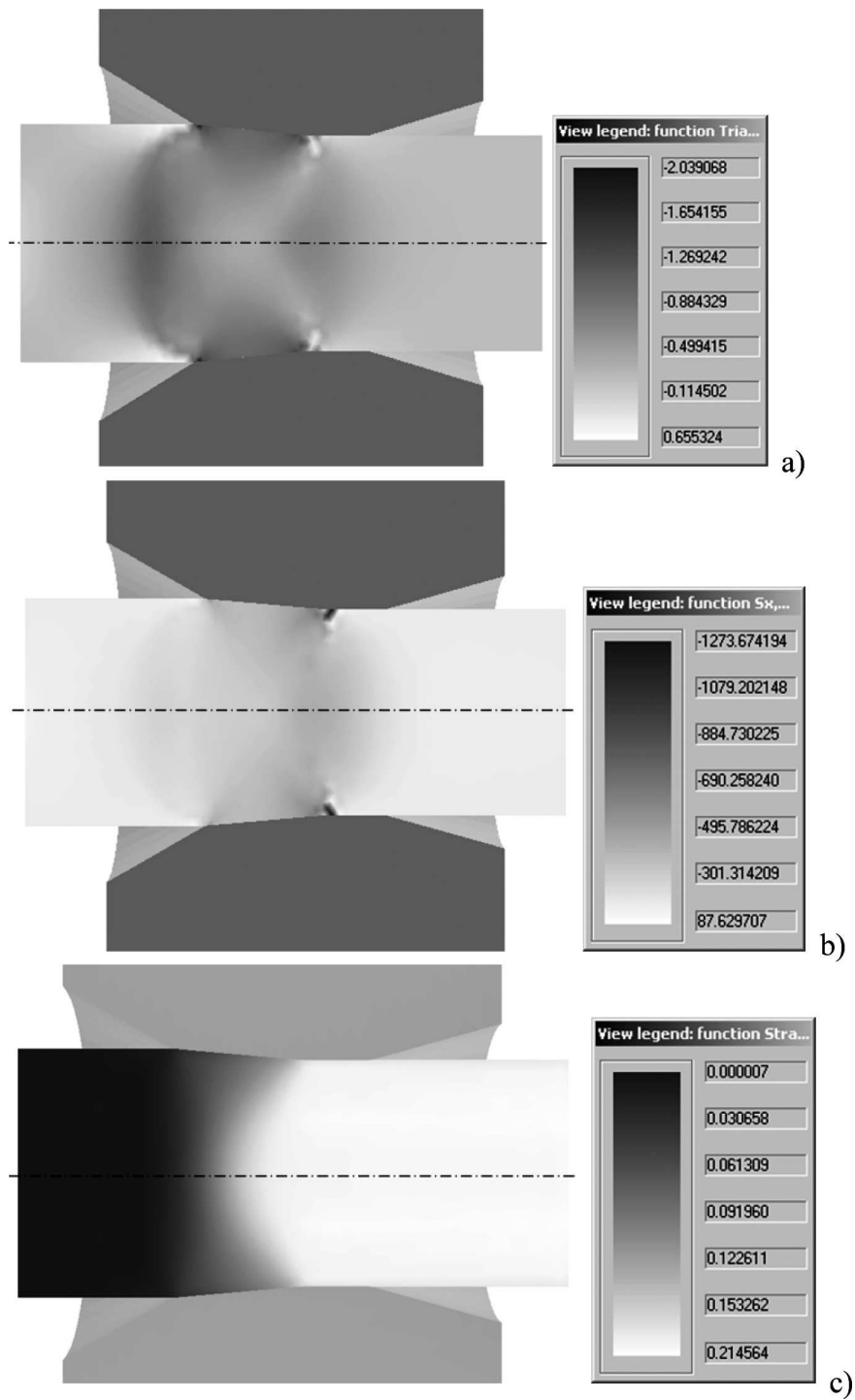

Fig. 5. Results of simulation of the first pass for variant 2: triaxiality factor  $\sigma_0/\bar{\sigma}$  (a),  $\sigma_x$ (b) and  $\bar{\epsilon}$  (c)

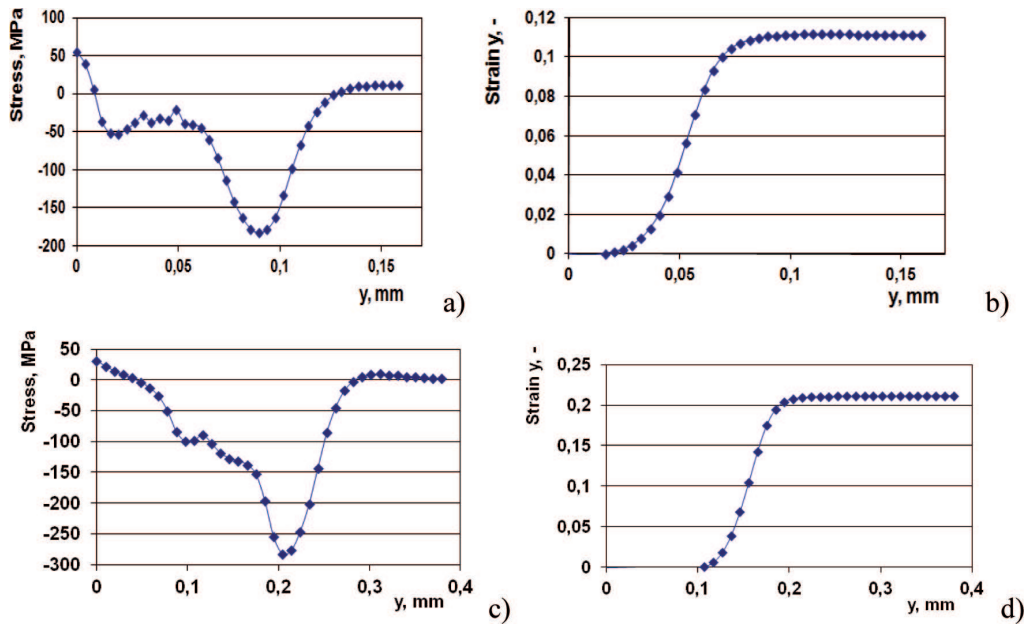

Fig. 6. The distribution of strain in the direction of drawing (b, d) and vertical stresses along the centre line of the zone of deformation (a, c) for variant 1 (a, b) and variant 2 (c, d)

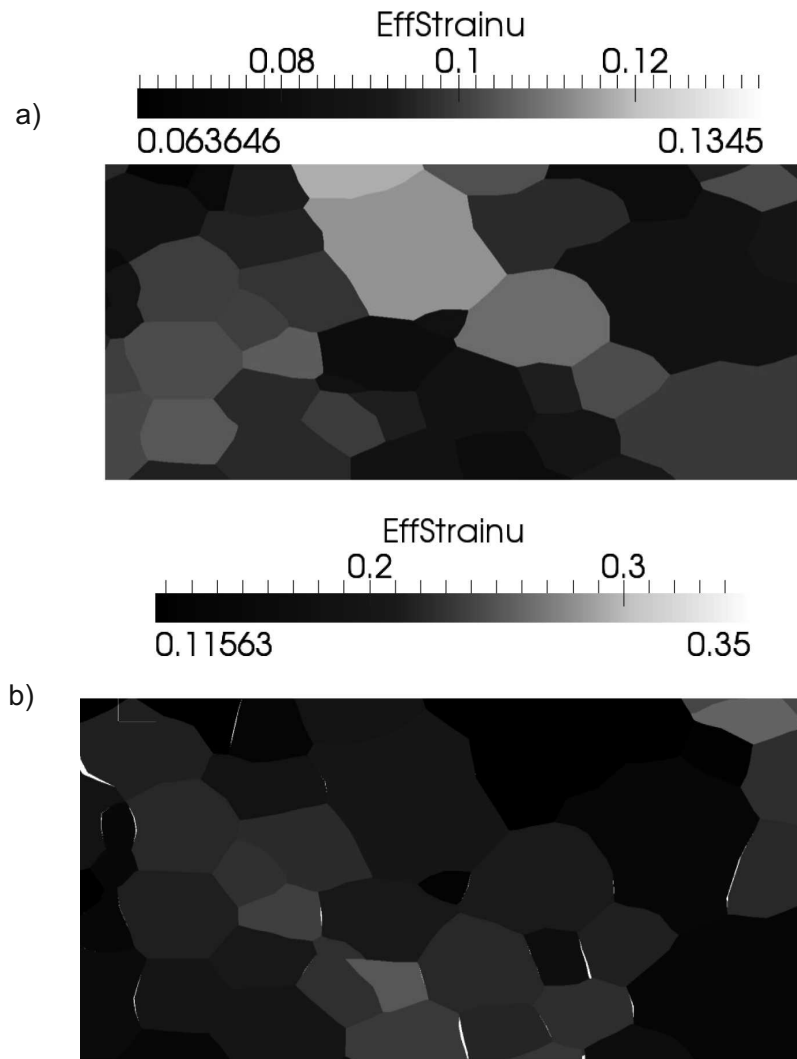

Fig. 7. Results of simulation of effective strain in meso scale: a – variant 1; b – variant 2

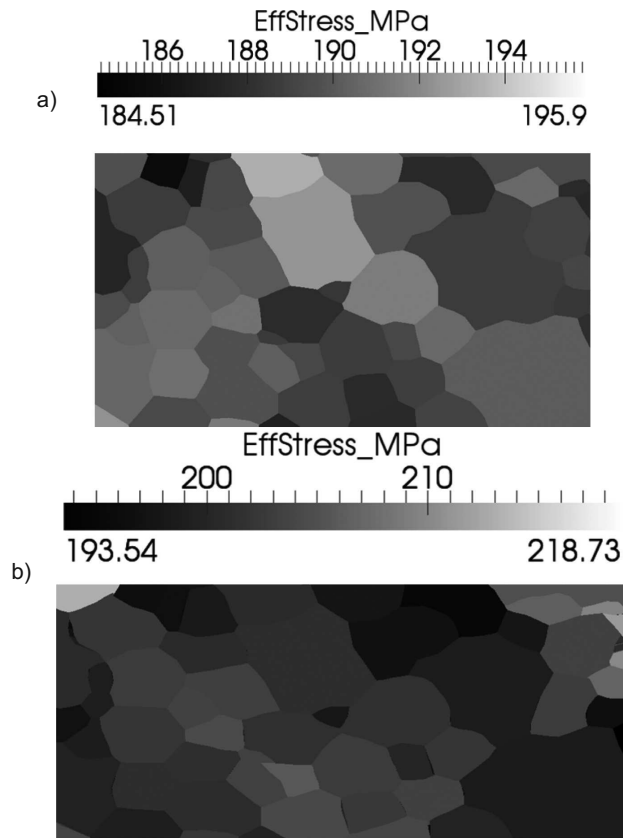

Fig. 8. Results of simulation of effective stress in meso scale: a – variant 1; b – variant 2

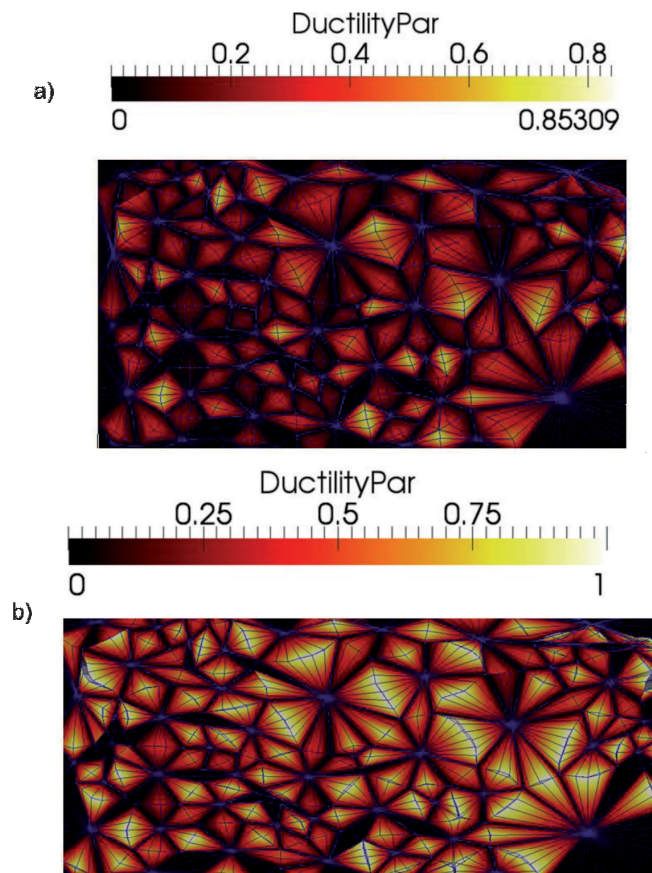

Fig. 9. Results of simulation of fracture parameters on grains boundaries in meso scale: a – variant 1; b – variant 2



## 5. Experimental validation of results

Experimental verification of the results of calculations performed in the context described above. Experiment was done using Ax30 magnesium alloy. Sunflower oil was used as a lubricant. The temperature of drawing was 30°C. Billet was obtained by hot wire drawing on the methodology presented in the [19]. Surface of the workpiece does not contain defects observed in the optical microscope.

The schema of the experimental rig, developed for experiment is shown in Fig. 10. Thus, annealing of wire (1) was carried out in a furnace (3) before deformation in drawing die (2). Velocity of drawing was 10-15 mm/s.

In the variant 2 only 4 passage were possible. After passage number 2 on the surface of the wire using an optical microscope can observe hairline fractures on the borders of grains. Obtained wire was fragile and crumble when trying to tie a knot after the 2nd pass. In Fig. 11 shows a developed network of cracks after 4 pass. Further attempts of annealing and drawing were unsuccessful.

By using variant 1 of the drawing the wire with much higher quality was obtained (Fig. 12), mechanical properties which allow further drawing. Study of mechanical properties on INSTRON machine showed that the  $R_m$  of wire for all passages is not changes significantly ( $d = 0.0955$  mm  $R_m = 250.7$  MPa,  $d = 0.0758$  mm  $R_m = 252.9$  MPa).

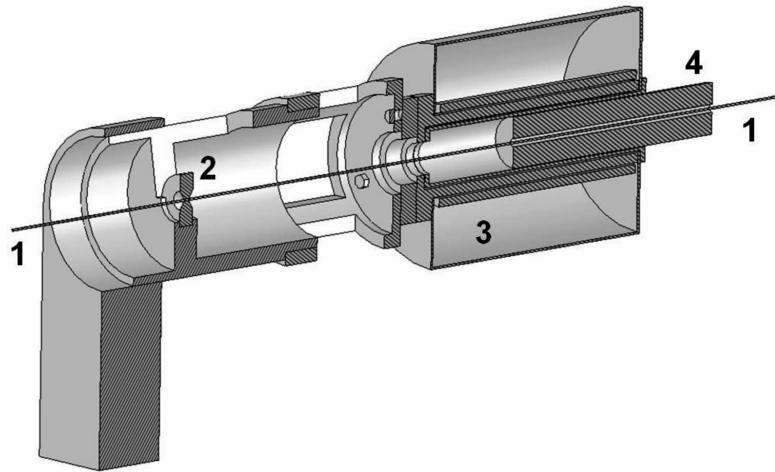

Fig. 10. Research experimental rig for cold drawing of Mg alloys with annealing (1 – wire, 2 – drawing die, 3 – annealing furnace, 4 – control the length of the heating zone)

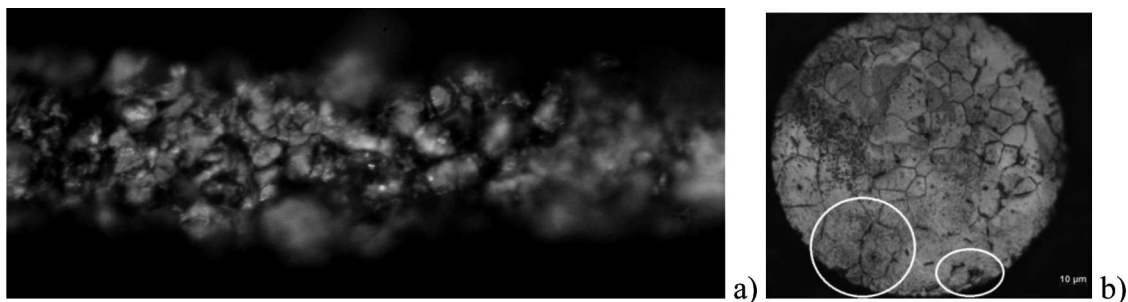

Fig. 11. Network of cracks after the 4th pass  $d=0.112$  mm, variant 2 (a – surface, b – section)

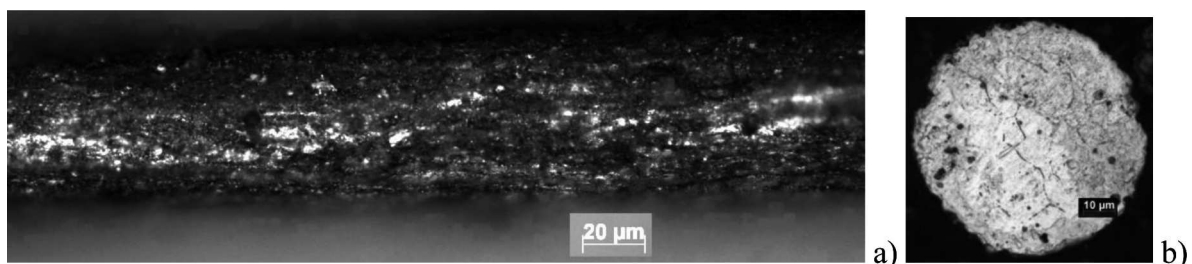

Fig. 12. Wire  $d= 0.0758$  mm after drawing according to variant 1 (a – surface, b – section)

## 6. Conclusions

1. It is shown that prediction of fracture on the grain boundaries is possible in the meso scale. Prediction is possible based on the proposed BEM model, which is based on the averaging of the mechanical properties of each grain depending on its orientation.

2. Prediction of the initiation of fracture using multi scale model coincided with the results of the experiment. Based on the developed schedule it was possible to get the wire with diameter 0.0758 mm from Ax30 alloy by cold drawing.

Financial assistance of the Ministry of Science and high Education of Poland, project no. 4131/B/T02/2009/37, is acknowledged.

## REFERENCES

- [1] B. Heublein, R. Rohde, M. Niemeyer, V. Kaese, W. Hartung, C. Röcken, G. Hausdorf, A. Haverich, Annual Symposium, Am. J. Cardiol., (1999).
- [2] H. Haferkamp, V. Kaese, M. Niemeyer, K. Phillip, T. Phan-Tan, B. Heublein, R. Rohde, Mat.-wiss. u. Werkstofftech **32**, 116-120 (2001).
- [3] M. Thomann, Ch. Krause, D. Bormann, N. von der Hoh, H. Windhagen, A. Meyer-Lindenberg, Mat.-wiss. u. Werkstofftech. **40**, 82-87, (2009).
- [4] A. Milenin, D.J. Byrska, O. Grydin, M. Schaper, Comput. Meth. Mater. Sci. **10**, 61-68 (2010).
- [5] P. Kustra, A. Milenin, M. Schaper, O. Grydin, Comput. Meth. Mater. Sci. **9**, 207-214 (2009).
- [6] A. Milenin, D. Byrska, O. Gridin, Comput Struct **89**, 1038-1049 (2011), doi:10.1016/j.compstruc.2011.01.003
- [7] J.-M. Seitz, D. Utermohlen, E. Wulf, C. Klose, F.-W. Bach, Adv. Eng. Mater. **13(12)**, 1087-1095, (2011).
- [8] A. Milenin, P. Kustra, J.-M. Seitz, Fr.-W. Bach, D. Bormann, Wire Ass. Int. Inc. Wire & Cable Technical Symposium, 61-70 (2010).
- [9] A. Milenin, P. Kustra, Proc. 11th Int. Conf. on Computational Plasticity, COMPLAS XI, 275-286 (2011).
- [10] A. Milenin, D.J. Byrska-Wójcik, O. Grydin, M. Schaper, Proc. 14th Int. Conf. on Metal Forming, Metal Forming 2012, Steel Res. Int. (spec. ed.), 863-866 (2012).
- [11] A. Milenin, P. Kustra, D.J. Byrska-Wójcik, Comput. Meth. Mater. Sci., in press (2013).
- [12] A. Milenin, Russian Metallurgy (Metally) **2**, 64-71 (1997).
- [13] A. Milenin, Hut.-Wiad. Hut. **72**, 100-104 (2005).
- [14] Ł. Rauch, K. Bzowski, Comput. Meth. Mater. Sci. **11**, 350-356 (2011).
- [15] S.L. Crouch, A.M. Starfield, Boundary element methods in solid mechanics, GEORGE ALLEN & UNWIN London, Boston, Sydney (1983).
- [16] Y.N. Rabotnov, Creep Problems in Structural Members, North-Holland, 1969.
- [17] O. Diard, S. Leclercq, G. Rousselier, G. Cailletaud, Comp. Mater. Sci. **18**, 73-84 (2002).
- [18] K. Yoshida, Steel Grips **2**, 199-202, (2004).
- [19] A. Milenin, P. Kustra, Archives of Metallurgy and Materials **58**, 1, (2013), in press.