

Z. GŁOWACZ*, J. KOZIK*

DETECTION OF SYNCHRONOUS MOTOR INTER-TURN FAULTS BASED ON SPECTRAL ANALYSIS OF PARK'S VECTOR**DETEKCJA ZWARĆ ZWOJOWYCH W SILNIKU SYNCHRONICZNYM BAZUJĄCA NA ANALIZIE SPEKTRALNEJ WEKTORA PRZESTRZENNEGO PRĄDU TWORNIKA**

This paper describes detection of synchronous motor inter-turn faults based on symptoms contained in stator phase currents. Armature short circuit, caused by insulation degradation are quite commonly occurring defects in electrical machines. Initially, short circuit comprises mostly single coils, causing the temperature rise due to higher value of current, which can reach up to tens times of the rated value. At the same time the phase current does not increase significantly. Increased temperature leads to rapid damage of the insulation and shorting the adjacent coils spreading the fault to the entire winding in a short time. Thus, it is very important to detect this type of fault in its early stage. Unfortunately currently used motor protection devices are insensitive to short-circuits of a small number of turns, because they cause too small quantitative changes in the phase currents. Phase currents begin to rise to the level detectable by protection devices when a large part of the winding is already covered by a fault. Therefore, there is a need for research on diagnostics of this type of damage. For the purpose of this paper a stepped short circuit fault of one coil group in the stator phase winding is performed. Shorting resistance values are chosen so that the short fault is diagnosed in its early stage. Spectral analysis of stator phase currents is carried out followed by spectral analysis of stator currents Park's vector. Comparison of the results of both studies shows that the signal of stator current Park's vector is more suitable in diagnostics of this type of faults.

Keywords: synchronous motor, faults diagnostics, Park's vector

Artykuł opisuje wykrywanie zwarć międzyzwojowych w silniku synchronicznym na podstawie sygnałów prądów fazowych stojana. Zwarcia w obwodzie twornika, powstałe na skutek degradacji izolacji są dość powszechnie występującymi uszkodzeniami w maszynach elektrycznych. Początkowo zwarcie obejmuje najczęściej pojedyncze zwoje powodując wzrost ich temperatury na skutek przepływu prądu o dużej wartości, dochodzącej nawet do kilkudziesięciokrotności prądu znamionowego. Prąd fazowy w tym czasie nie ulega znacznemu zwiększeniu. Pod wpływem zwiększonej temperatury dochodzi w bardzo krótkim czasie do uszkodzenia izolacji sąsiednich zwojów i zwarcie bardzo szybko rozprzestrzenia się obejmując w dość krótkim czasie całe uzwojenie. Zatem bardzo ważne jest, aby tego typu uszkodzenie wykrył w jego początkowym stadium. Niestety stosowane obecnie układy zabezpieczeń są niewrażliwe na zwarcia niewielkiej liczby zwojów, gdyż powodują one zbyt małe zmiany ilościowe w prądach fazowych. Prądy fazowe zaczynają wzrastać do poziomu, na który mogą zareagować zabezpieczenia dopiero wtedy, gdy zwarcie obejmuje już znaczną część uzwojenia. Dlatego istnieje potrzeba badań tego typu uszkodzeń. Na potrzeby artykułu dokonywano stopniowanego zwarcia grupy zwojów w jednej z faz stojana. Wartości rezystancji zwierającej dobrano tak, aby była to diagnostyka we wczesnym stadium uszkodzenia. Przeprowadzona została analiza spektralna prądów fazowych stojana oraz analiza spektralna wektora przestrzennego prądu stojana. Porównanie wyników obu tych analiz wykazało, że sygnał wektora przestrzennego prądu stojana (tzw. wektor Parka) lepiej niż prądy fazowe nadaje się do diagnostyki tego typu zwarć.

1. Introduction

Electrical machines, especially of synchronous type have a very wide application in the metallurgical industry. This is because of their main advantages – the constant angular velocity of the rotor and high efficiency. They can be found in rolling extrusion systems [1], mill stands [2], vacuum pumping [3] and also testing stands, i.e. the rotating hammer for testing the effect of deformation velocity on the properties of metal sheets [4]. In most of these applications a high reliability

is expected, and any interruptions usually lead to very expensive breaks in production process. Thus the possibility of fault of every part of the process including motors needs to be reduced to a minimum. The motors similarly to the other electrical and mechanical devices, are constantly exposed to both external and internal influences which cause the changes to their physical state and functionality [5]. These gradually developing irreversible changes worsen the efficiency of the motor and thus the industrial process it is the part of, and finally can lead to complete damage to the machine. To min-

* AGH UNIVERSITY OF SCIENCE AND TECHNOLOGY, FACULTY OF ELECTRICAL ENGINEERING, AUTOMATICS, COMPUTER SCIENCE AND BIOMEDICAL ENGINEERING, DEPARTMENT OF ELECTRICAL MACHINES, 30-059 KRAKÓW, AL. MICKIEWICZA 30, POLAND

imize these adverse effects the state of the machine should be periodically checked allowing the maintenance works to be done before the fault develops. Rapid development of a digital measurement techniques in the last decades created new possibilities of machines condition diagnostics, which do not require any disintegration to the machine, and can be undertaken even without stopping the process it is serving. These new methods include: spectral analysis of currents [6-9], axis flux [10], vibration and sound analysis [11], [12], thermal pattern recognition. This paper describes a recognition of short-circuit faults in a synchronous motor stator windings based on analysis of stator currents and their Park's vector.

2. Measuring stand and testing procedures

As the diagnostic object a specially designed and constructed 2-pair pole synchronous machine was used. The stator of the machine consists of 48 slots with double layer windings inside (80 turns per phase). The rotor is of salient pole type with 4 poles and 145 turns per pole. All the ends of every group of windings are accessible allowing simulation of many fault conditions to be done. For the purpose of this paper a gradually increasing short fault in the stator winding was performed. This was done using a variable resistor connected in parallel with one group of coils in one stator phase of the motor. The connection diagram of stator windings with one coil group shorted by a variable resistor is presented in the Figure 1.

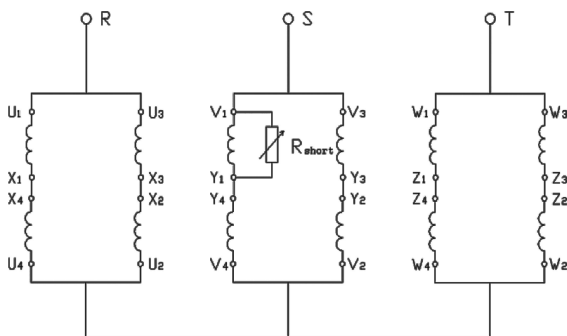

Fig. 1. Diagram of stator windings arrangement with shorting resistor connected

The value of shorting resistance was varied from 3,45 [Ω] to 1,3 [Ω] in five steps. Investigated synchronous motor was mechanically loaded by separately excited DC machine as can be seen in the diagram shown in the Figure 2. Three phase currents were recorded using PC with installed data acquisition card. Currents were converted to voltages having ranges acceptable by an acquisition card using three current transducers (LEM LTS 6-NP). To avoid an aliasing phenomena three antialiasing filters were used. In that role three Butterworth 4th order low-pass filters were adopted. The cutoff frequency was 5kHz. Recorded signals were sampled with a frequency of 25kHz.

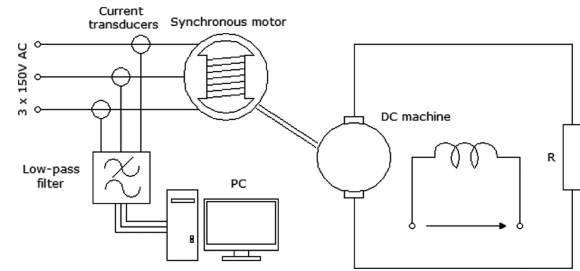

Fig. 2. Schematic diagram of the measuring stand

To reduce the impact of ripples in supply voltage on the results of analysis a great number of samples was recorded – 200 for each motor condition giving the overall number of 1200 samples.

There were six motor conditions investigated, including:

- healthy state,
- short circuit using 3,45 [Ω] resistor,
- short circuit using 2,47 [Ω] resistor,
- short circuit using 2,00 [Ω] resistor,
- short circuit using 1,54 [Ω] resistor,
- short circuit using 1,30 [Ω] resistor.

Recordings for each condition were undertaken in 5 different days (40 recordings per condition per day). Additionally a different devices were supplied from the same power source as the investigated motor. These devices included power inverter supplying induction motor and two faulty induction motors. This caused the analysis even more resistant on the interference from the power supply.

The arrangement of testing stand allowed for measuring also the value of current in the shorting circuit, which normally, in the case of machines working in the industrial environment is impossible. The values of current (RMS values) in shorting circuit were as follows:

- 12,8 [A], when shorted with 3,45 [Ω] resistor,
- 19,0 [A], when shorted with 2,47 [Ω] resistor,
- 23,3 [A], when shorted with 2,00 [Ω] resistor,
- 30,6 [A], when shorted with 1,54 [Ω] resistor,
- 37,6 [A], when shorted with 1,30 [Ω] resistor.

As can be seen the value of current in shorting circuit is significantly increasing with the drop of the value of shorting resistance. The value of phase current in all these five cases was at almost the same level as in the healthy state amounting to about 18 [A]. So the monitoring of the value of phase current does not allow for detection of stator winding short circuits in their early stage and more sophisticated detection methods are required.

3. Spectral analysis of stator currents

One of well known methods of faults detection used mainly in the diagnostics of induction motors is Motor Current Signature Analysis (MCSA) [13]. This method is based on spectral analysis of stator currents and searching currents spectra for existing of components that may indicate the occurrence of particular damage. Although this method is well established for induction motors, in the case of motors of synchronous type there are few references in the literature [14]. Authors attempted to adopt this method in diagnostics of inter turn short circuit faults in stator windings of synchronous

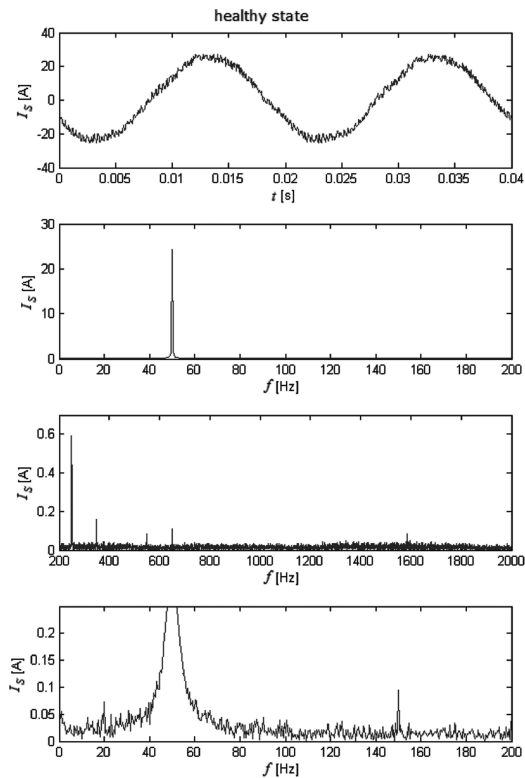

Fig. 3. Stator current waveform and its frequency spectrum in a healthy state

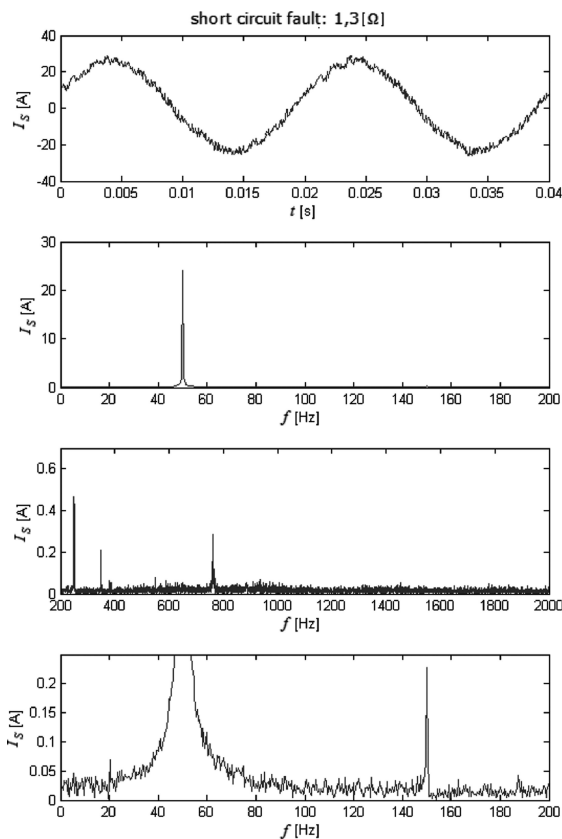

Fig. 4. Stator current waveform and its frequency spectrum during the short fault in one group of coils of stator winding

machine. For that purpose every recording sample was transformed to frequency domain using Fast Fourier Transform

(FFT). Exemplary current waveforms and their frequency spectra for two motor conditions, respectively healthy state and short of the one coil group in the stator phase with the 1,30 [Ω] resistor are shown in the Figures 3 and 4. Analysis of all spectra showed that during synchronous operation of the motor the largest amplitudes belongs to components of the frequencies that are integer multiples of 25 Hz. This is associated with the constant rotor speed of 1500 rpm (rounds per minute). It is quite clearly visible in the Figures 3 and 4 and is also confirmed in the literature [14]. The amplitudes of remaining components (components of frequencies not being the integer multiples of 25 Hz) are at the noise level. It should be noted that however there are some differences between the spectra in the Figures 3 and 4 any conclusions can be done by comparing greater number of samples, as the differences seen in both Figures (3 and 4) may result from varying supply conditions and are not the signature of the fault.

As it was previously mentioned for each motor condition 200 recordings were performed. All the 6 sets of 200 samples were compared between each other. The exemplary result of comparison between healthy state and the short circuit of the one coil group in the stator phase with the 1,30 [Ω] resistor is presented in the Figure 5 (only 25Hz multiples are shown).

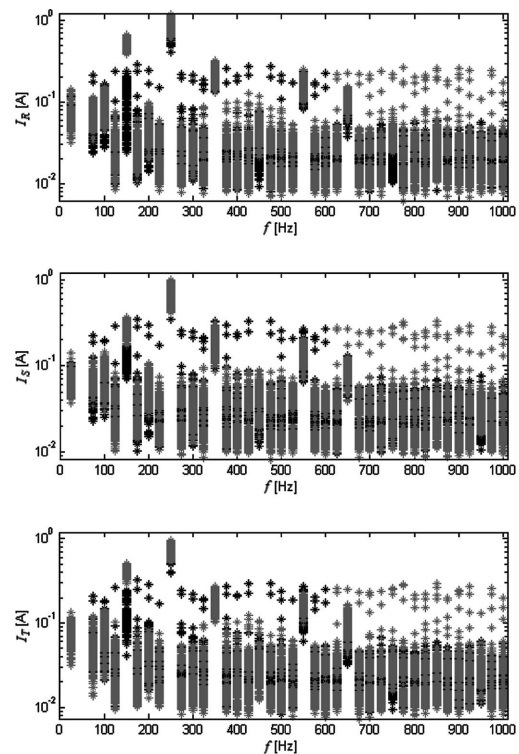

Fig. 5. Amplitudes corresponding to individual frequencies in a healthy state (black) and during inter-turn short circuit fault in one coil group of the stator phase (red)

The fault were performed in the phase S, but, as can be seen in the Figure 5, current signatures of the three phase currents does not allow for discerning which phase was affected by a fault. It can also be seen that only the frequency of 150Hz can give two separable aggregations of amplitude values for healthy and for faulty states of the motor. However the dispersion of amplitudes in each of the two groups is quite large. To check if the amplitude of 150Hz component provide a good

diagnostic information the amplitudes of that component in different degrees of fault and in healthy state were compared. The results of such a comparison are presented in the Figure 6.

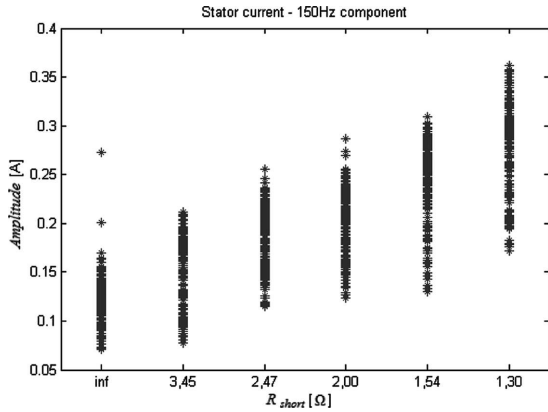

Fig. 6. Dependence between the value of shorting resistance and the value of stator current amplitude corresponding to frequency of 150Hz

As can be seen in the picture 6 there is no clear difference in the amplitudes values depending on the degree of a fault. Thus spectral analysis of stator currents appears to be ineffective in diagnosing the occurrence of short circuit faults in the synchronous motor stator windings.

4. Park's vector

Recently used and giving good results method for detection of faults in electrical machines is analyzing the spectrum of Park's vector absolute value. This method is also well established for induction motors, but there are few references in the literature for the motors of synchronous type.

Park's vector consists of two orthogonal components I_D , I_Q , which are related to stator phase currents I_R , I_S , I_T through the following formulae [15], [16]

$$\mathbf{i} = I_D + jI_Q = \sqrt{\frac{2}{3}} (I_R + \mathbf{a}I_S + \mathbf{a}^2I_T) \quad (1)$$

where:

$$\mathbf{a} = -\frac{1}{2} + j\frac{\sqrt{3}}{2}, j = \sqrt{-1},$$

I_R , I_S , I_T – instantaneous values of stator currents.

The orthogonal components of the Park's vector can be expressed as:

$$I_D = \sqrt{\frac{2}{3}}I_R - \frac{1}{\sqrt{6}}I_S - \frac{1}{\sqrt{6}}I_T \quad (2)$$

$$I_Q = \frac{1}{\sqrt{2}}I_S - \frac{1}{\sqrt{2}}I_T \quad (3)$$

The absolute value of Park's vector can be calculated using the following equation:

$$I = \sqrt{I_D^2 + I_Q^2} \quad (4)$$

5. Spectral analysis of Park's vector absolute value

Previously used procedure (MCSA) was modified by adding the calculation of Park's vector orthogonal components and the calculating the absolute value. This procedure is shown in the Figure 7. Every of 1200 recording sample was subjected to calculation of Park's vector absolute value which was transformed to frequency domain using Fast Fourier Transform (FFT). Exemplary frequency spectra for two motor conditions, respectively healthy state and short of the one coil group in the stator phase with the 1,30 [Ω] resistor are shown in the Figures 8 and 9.

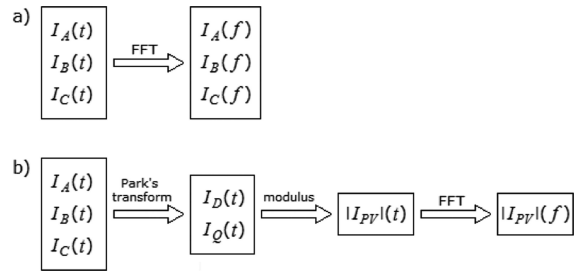

Fig. 7. Diagram of procedures for obtaining stator currents spectra (a), and Park's vector absolute value spectrum (b)

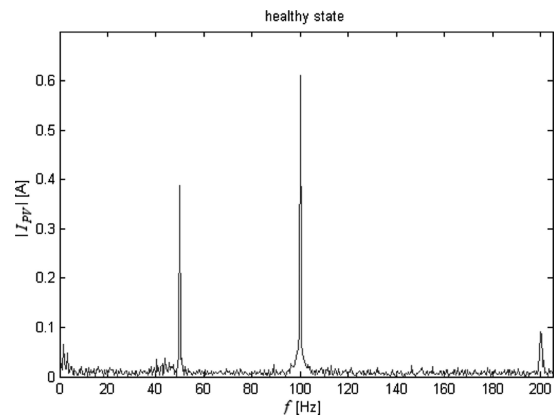

Fig. 8. Stator Park's vector absolute value frequency spectrum in a healthy state

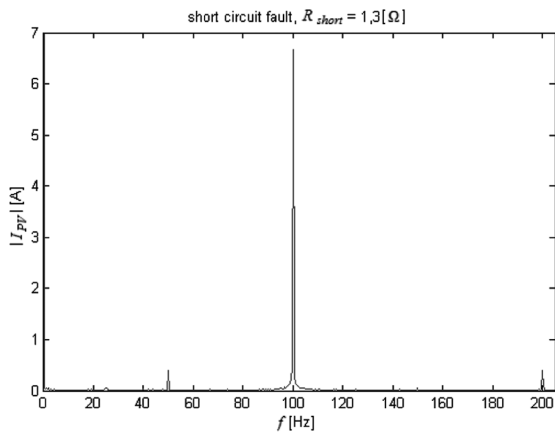

Fig. 9. Stator Park's vector absolute value frequency spectrum during the short circuit fault in a one coil group in the stator winding

Comparison of both Figures (8 and 9) shows that occurrence of short fault in the stator windings causes signifi-

cant rise in the value of amplitude corresponding to 100Hz in the spectrum of Park's vector absolute value. However correct conclusions can be done by comparing greater number of samples (all 1200 samples). This helps to avoid mistaken estimates resulting from varying supply and load conditions during the recording of particular samples.

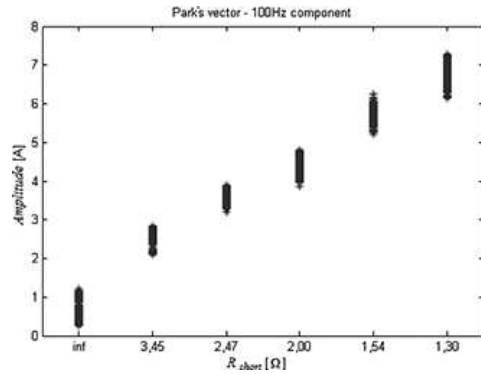

Fig. 10. Dependence between the value of shorting resistance and the Park's vector absolute value corresponding to frequency of 100Hz

As can be seen in the Figure 10 the separability between samples corresponding to different values of shorting resistance is very high and allows to discern between the motor condition. Comparison of Figures 6 and 10 leads to a conclusion that the analysis of stator current Park's vector absolute value gives much better results than the analysis of the values of phase currents.

6. Conclusions

Studies showed that stator currents of the synchronous motor contain the information about the motor state and can be successfully used in the diagnosing of short circuit faults in the stator windings. However analysis performed on the currents directly does not give the clear information that would allow for discerning between healthy and faulty states. Diagnostics can be improved by calculation of Park's vector absolute value and analyzing its spectrum. This method gives good results and the risk of making the wrong diagnosis is reduced. Such a procedure allows for constant (on-line) controlling the machine state and taking appropriate actions in the case of detecting the fault in its early stage. This can significantly reduce the cost of motor repair, and, what is even more important, the cost of stopping the production process.

REFERENCES

- [1] J. Bartnicki, Z. Pater, G. Samołyk, The Distributions of Wall-Thickness of Hollowed Parts in Rolling Extrusion Process, *Archives of Metallurgy and Materials* **52**, 2 (2007).
- [2] J. Kempken, G. Kleinschmidt, K. Schmale, U. Thiedemann, H.P. Gaines, J.T. Kopfle, Short Route – Long-Term Success, Integrated Mini-Mill Solutions by Midrex and SMS Demag, *Archives of Metallurgy and Materials* **53**, 2 (2008).
- [3] A. Niechajowicz, A. Tobota, Dynamic Tension Testing of DP600, DP800 Steel and Al 6061 T4 Alloy Sheets by Means of Rotary Hammer, *Archives of Metallurgy and Materials* **54**, 3 (2009).
- [4] S. Bruce, V. Cheetham, Recent Developments and Experiences in Modular Dry Mechanical Vacuum Pumping Systems for Secondary Steel Processing, *Archives of Metallurgy and Materials* **53**, 2 (2008).
- [5] J. Korbicz, J.M. Kościelny, Z. Kowalczyk, W. Cholewa, *Diagnostyka procesów. Modele. Metody sztucznej inteligencji. Zastosowania*. WNT, Warszawa, 2002.
- [6] J. Kozik, Zastosowanie sieci neuronowych w detekcji uszkodzeń silnika synchronicznego ze zwartym uzwojeniem wirnika, *Zeszyty Problemowe – Maszyny Elektryczne*, nr 80/2008, PEMINE: Problemy Eksploatacji Maszyn i Napędów Elektrycznych, Ryto, 2008.
- [7] Z. Głowacz, J. Kozik, Faulty states detection of synchronous motor using neural network, *Zagadnienia maszyn, napędów i pomiarów elektrycznych*. Oficyna Wydawnicza Politechniki Wrocławskiej, Wrocław, 2008.
- [8] Z. Głowacz, J. Kozik, Diagnostyka silnika synchronicznego oparta na rozpoznawaniu prądów stojana z zastosowaniem FFT i logiki rozmytej, *Mechanizacja i Automatyzacja Górnictwa (MIAG)*, Nr 9, 2010.
- [9] Z. Głowacz, Automatic Recognition of Armature Current of DC Motor with Application of FFT and GSDM, *Archives of Metallurgy and Materials* **56**, 1 (2011).
- [10] M. Gołębiowski, L. Gołębiowski, J. Skwarczyński, M. Noga, Strumień osiowy w modelu 3D MES maszyny indukcyjnej, *Proceedings of International Symposium on Electrical Machines (SME)*, Cracow, 2006.
- [11] A. Głowacz, Z. Głowacz, Diagnostics of Induction Motor Based on Analysis of Acoustic Signals with Application of FFT and Classifier Based on Words, *Archives of Metallurgy and Materials* **55**, 3 (2010).
- [12] A. Głowacz, W. Głowacz, Diagnostics of Synchronous Motor Based on Acoustic Signals with Application of LPCC and Nearest Mean Classifier with Cosine Distance, *Archives of Metallurgy and Materials* **55**, 2 (2010).
- [13] W.T. Thomson, M. Fenger, Current Signature Analysis to Detect Induction Motor Faults, *IEEE Industry Applications Magazine*, July/August, 2001.
- [14] K. Weinreb, M. Sułowicz, Nieinwazyjna diagnostyka wewnętrznych niesymetrii uzwojeń maszyny synchronicznej, *Zeszyty Problemowe – Maszyny Elektryczne*, Nr 77, 2007.
- [15] S. Cruz, M. Cardoso, Stator Winding Fault Diagnosis in Three-Phase Synchronous and Asynchronous Motors, by the Extended Park's Vector Approach, *IEEE Transactions on Industry Applications* **37**, 5, Sept/Oct, 2001.
- [16] S. Das, P. Purkait, S. Chakravorti, Space-vector characterization of induction motor operating conditions, *Proceedings of Fifteenth National Power Systems Conference (NPSC)*, Bombay, 2008.