

A. ZIĘBIK*, M. WARZYC*, P. GŁADYSZ*

DETERMINATION OF THE OPTIMAL STRUCTURE OF REPOWERING A METALLURGICAL CHP PLANT FIRED WITH TECHNOLOGICAL FUEL GASES

DOBÓR OPTYMALNEJ STRUKTURY ELEKTROCIEPŁOWNI GAZOWO-PAROWEJ OPALANEJ HUTNICZYMI GAZAMI PALNYMI

CHP plants in ironworks are traditionally fired with low-calorific technological fuel gases and hard coal. Among metallurgical fuel gases blast-furnace gas (BFG) dominates. Minor shares of gaseous fuels are converter gas (LDG) and surpluses of coke-oven gas (COG). Metallurgical CHP plant repowering consists in adding a gas turbine to the existing traditional steam CHP plant. It has been assumed that the existing steam turbine and parts of double-fuel steam boilers can be used in modernized CHP plants. Such a system can be applied parallelly with the existing steam cycle, increasing the efficiency of utilizing the metallurgical fuel gases.

The paper presents a method and the final results of analyzing the repowering of an existing metallurgical CHP plant fired with low-calorific technological fuel gases mixed with hard coal. The introduction of a gas turbine cycle results in a better effectiveness of the utilization of metallurgical fuel gases. Due to the probabilistic character of the input data (e.g. the duration curve of availability of the chemical energy of blast-furnace gas for CHP plant, the duration curve of ambient temperature) the Monte Carlo method has been applied in order to choose the optimal structure of the gas-and-steam combined cycle CHP unit, using the Gate Cycle software. In order to simplify the optimizing calculation, the described analysis has also been performed basing on the average value of availability of the chemical energy of blast-furnace gas. The fundamental values of optimization differ only slightly from the results of the probabilistic model.

The results obtained by means of probabilistic and average input data have been compared using new information and a model applying average input data. The new software Thermoflex has been used. The comparison confirmed that in the choice of the power rating of the gas turbine based on both computer programs the results are similar.

Keywords: metallurgical CHP plant, combined gas-and-steam cycle, structure optimization, probabilistic approach

Tradycyjnie elektrociepłownie hutnicze są opalane niskokalorycznymi palnymi gazami technologicznymi w mieszaninie z pyłem węgla kamiennego. W mieszaninie gazów dominujący jest udział gazu wielkopiecowego. Znacznie mniejsze są udziały gazu koksowniczego i konwertorowego. Modernizacja elektrociepłowni hutniczej (tzw. repowering) polega na dobudowaniu do istniejącej struktury członu gazowego. W analizie założono możliwość wykorzystania istniejących turbin parowych oraz części dwupaliwowych kotłów parowych. Układ gazowo-parowy zostanie połączony równolegle z istniejącym obiegiem parowym, zwiększając tym samym efektywność energetyczną wykorzystania niskokalorycznych gazów hutniczych.

W artykule zaprezentowano metodologię oraz wyniki końcowe przeprowadzonej analizy modernizacji istniejącej elektrociepłowni hutniczej opalanej niskokalorycznymi gazami hutniczymi w mieszaninie z pyłem węgla kamiennego. Bazowano przy tym na zbiorze danych wejściowych z lat 1996-2000. Z uwagi na probabilistyczny charakter danych wejściowych (m.in. wykres uporządkowany dostępności energii chemicznej gazu wielkopiecowego oraz wykres uporządkowany temperatury zewnętrznej) wykorzystano metodę Monte Carlo w celu doboru optymalnej struktury kombinowanego gazowo-parowego układu elektrociepłowni wykorzystując do tego oprogramowanie Gate Cycle. Obliczenia optymalizacyjne zostały również przeprowadzone w oparciu o uśrednioną wartość strumienia energii chemicznej gazu wielkopiecowego dostępnego dla elektrociepłowni. Wyniki obliczeń podstawowych parametrów z tej analizy różnią się w nieznacznym stopniu od wyników uzyskanych za pomocą modelu probabilistycznego.

Wyniki uzyskane zarówno z metody probabilistycznej, jak i bazującej na wartościach średnich danych wejściowych zostały porównane z rezultatami obliczeń w oparciu o nowy zestaw danych (lata 2005-2008), jak również nowy model utworzony w programie Thermoflex oraz Engineering Equation Solver. Obliczenia zostały przeprowadzone w oparciu o uśredniony strumień energii chemicznej gazu wielkopiecowego dostępnego dla elektrociepłowni. Zastosowane do doboru struktury modernizowanej elektrociepłowni hutniczej programy komputerowe Gate Cycle i Thermoflex dały zbliżone rezultaty.

Nomenclature

BFG	–	blast-furnace gas,
CHP	–	combined heat and power,
\dot{E}	–	flux of energy,
J	–	investment expenditure,
k	–	unit cost,
LHV	–	lower heating value,
N_{el}	–	electrical power of CHP plant,
S_n	–	net income,
$\delta\dot{E}$	–	losses of the chemical energy of BFG,
τ_a	–	annual time of CHP plant exploitation.

Subscripts

BFG	–	blast-furnace gas,
c	–	coal,
ch	–	chemical,
CHP	–	at CHP plant,
COG	–	coke-oven gas,
CS	–	Cowper-stoves,
eco	–	ecological,
el	–	electricity,
exist	–	existing,
gas prep	–	gas preparation devices,
GC	–	gas compressor,
GT	–	gas turbine,
HRSG	–	heat recovery steam generator,
LDG	–	converter gas,
MS	–	mixing station,
ng	–	natural gas,
pip	–	piping and instrumentation,
pr	–	production,
rep	–	after repowering.

1. Repowering of metallurgical CHP plants

CHP plants in ironworks are usually fired with a mixture of hard coal and low-calorific technological fuel gases [1]. The dominating gaseous fuel is in this case blast-furnace gas (BFG) with a lower heating value (LHV) of 70÷75 MJ/kmol. The substantial part of BFG is used in metallurgical processes (Cowper stoves and heating furnaces). Its remaining part feeds the metallurgical CHP plant. The converter gas (LDG), a by-product of the converter process of smelting, is also passed to the metallurgical CHP plant. The LHV of this technological fuel gas is about 180 MJ/kmol. Occasionally also surpluses of coke-oven gas (COG) with a LHV of 380 MJ/kmol are used in metallurgical CHP plants.

Traditionally, metallurgical fuel gases are fired both with hard coal and metallurgical fuel gases in double-fuel boilers. The energy characteristic of double-fuel boilers fired with hard coal and technological fuel gases depends on the share of fuel gases in the mixture. Because the BFG dominates, the fuel gas mixture is characterized by a high content of N_2 and CO_2 .

This leads to a decrease of the adiabatic temperature of combustion gases and therefore the amount of heat exchanged in the combustion chamber is reduced. Therefore, the maximum capacity of double-fuel boilers drops (Fig. 1) when the share of the chemical energy of BFG in the fuel mixture increases. If the share of BFG in the mixture is increased, the flux of combustion gases increases too, resulting in their insufficient cooling and a rise of flue gases. The deterioration of the combustion and heat transfer conditions in the double-fuel boiler and the losses caused by incomplete combustion determine the energy efficiency of the double-fuel boiler which reaches its minimum at a share of the chemical energy of BFG amounting to about 60 % (Fig. 2) [1]. The highest efficiency of the double-fuel boiler is attained when it is fired only with coal. In the case of firing it with BFG only this efficiency is lower by several percent. For this reason the effectiveness of the utilization of BFG in traditional CHP plants is not as high as in the case of applying combined cycle CHP plants. In many metallurgical CHP plants for several years combined cycles have successfully been in operation. Such a system can be applied parallelly with the existing steam cycle, increasing the efficiency of utilizing the metallurgical fuel gases. This is usually called *repowering*.

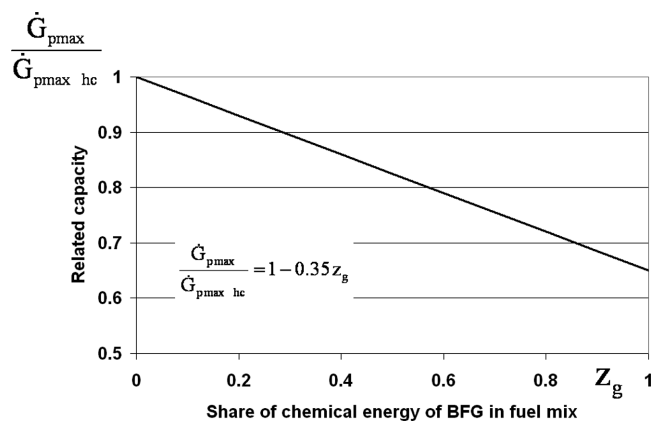

Fig. 1. Capacity of double-fuel boiler vs. share of chemical energy of BFG; \dot{G}_{pmax} – maximum capacity of the boiler fired with fuel mix, $\dot{G}_{pmax hc}$ – maximum capacity of the boiler fired with hard coal

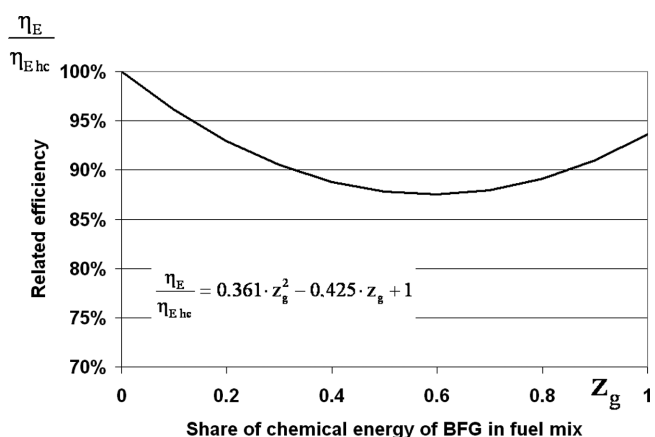

Fig. 2. Efficiency of double-fuel boiler vs. share of chemical energy of BFG; η_E – energy efficiency of the boiler fired with fuel mix, $\eta_{E hc}$ – energy efficiency of the boiler fired with hard coal

The LCA analysis of the metallurgical CHP plant presented in [2] indicates that the utilization of blast-furnace gas is always a more advantageous option for the environment than the technology of firing with coal. The modernization of a metallurgical CHP plant consisting in the application of the gas-steam system with a gas turbine fired with blast-furnace gas is a still better environmental solution thanks to the increased energy effectivity in the utilization of blast-furnace gas.

The combined cycle fed with metallurgical fuel gases requires some changes when compared with CHP's fired with natural gas [3]. The application of high efficiency electro-filters is inevitable in order to clean the metallurgical fuel gas before it can be used in GT. An additional element which must be included in the cycle is a gas compressor because the pressure of the metallurgical gas mixture is only slightly higher than the atmospheric pressure. Moreover, washing installation must be applied to clean the blades of the gas compressor from the deposits formed by contaminations. It may also be necessary to introduce significant changes into the design of the combustion chamber due to the low LHV of the mixture of metallurgical fuel gases. An important role is also played by the lower rate of combustion. As the mixture contains toxic CO, this gas should not be emitted to the atmosphere. In CHP's fed with metallurgical fuel gases; therefore, a by-pass installation is used to expand and cool down the compressed gas in order to permit its recycling to the inlet collector. These specific problems affect, of course, the initial investment but do not preclude the possibility of utilizing metallurgical fuel gases in the GT cycle. This has been confirmed by several practical implementations of combined cycle CHP plants fired with technological fuel gases.

The interest in applying more effective ways of utilizing low-calorific metallurgical fuel gases increased due to the so-called *energy crisis* in the seventies of the former century. Towards the end of eighties of the last century Mitsubishi Heavy Industries installed in Chiba Works a combined cycle CHP unit fired with a mixture of blast-furnace gas, an LD converter gas and coke-oven gas equipped with a GT (124 MW) and double pressure HRSG (6.5 MPa; 518°C – 0.83 MPa, 281°C), [4]. The steam turbine has a power rating of about 58 MW and the gas compressor 37 MW. The power rating of the unit is 145 MW, while the efficiency of electricity production amounts to 46%.

An identical unit, provided by this company, has been installed at the power station Velsen of the ironworks Hoogovens (Netherlands) [5]. This system is fed with a mixture of BFG and LDG with an admixture of natural gas, so that the required LHV of this mixture amounting to 4.2 MJ/Nm³ would be obtained. The achieved electrical efficiency reached 45.6%. The content of dust is limited to 1 mg/ Nm³.

In the ironworks of Taranto (Italy) a combined cycle CHP plant has been installed comprising three modules with an overall power rating of 530 MW, utilizing metallurgical fuel gases [6]. This system differs from that described above, among others, by the application of natural gas which may be not only a component of the mixture, but also alternative fuel, also combusted in HRSG as additional fuel. Every module is equipped with a conventional GT (manufactured by Nuovo Pignone/Turbotechnica) with a power rating of 103 MW after

some constructional changes of the combustion system in order to permit the combustion of both a low-calorific fuel mixture and natural gas. The exhaust-condensing steam turbine has a power rating of 86 MW. The efficiency of electricity production amounts to 43.4%.

2. An outline of the considered ironworks and its CHP plant

Fig. 3 illustrates the structure of input energy of the considered ironworks [7]. There are four major metallurgical plants: the sintering plant, blast-furnace assembly, LD converter plant and assembly rolling mills (semiproducts and final rolled products). Coke and coke-oven gas are supplied from outside. The blast-furnace plant consists of three units, each of them with a volume of 3200 m³. The blast is compressed up to 0.5 MPa and preheated to 1100÷1150°C, and enriched with oxygen up to the level of about 23%. Usually two blast-furnace units are operated.

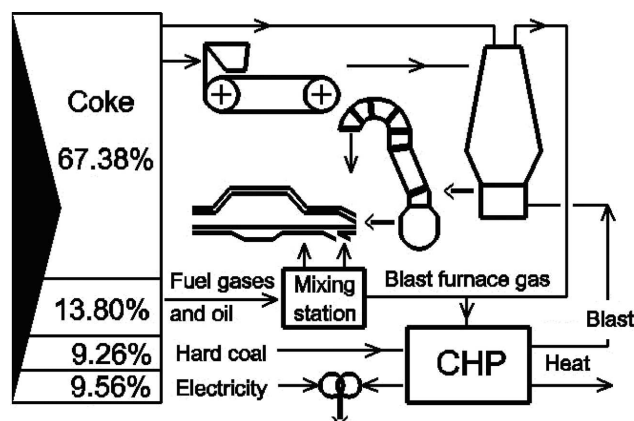

Fig. 3. Structure of energy in ironworks

Figs. 4 and 5 present diagrams of average annual values of the blast-furnace gas flux available for the CHP plant and its LHV. These diagrams concern a five-year period of operation up to the year 2000 and the four-year period of operation in the current century.

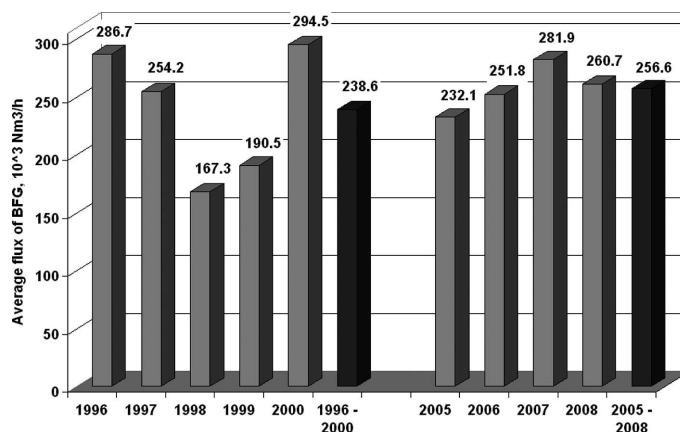

Fig. 4. Average values of BFG's flux in CHP plant

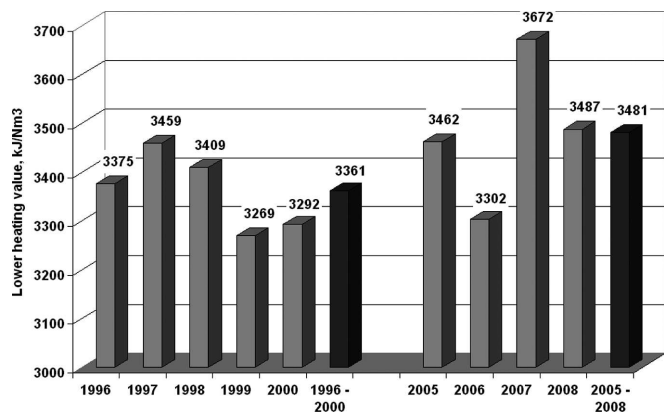

Fig. 5. Average lower heating values of BFG

The flux of blast-furnace gas available for CHP plant results from the instantaneous balance of top gas production and its consumption by the respective consumers (mainly Cowper stoves and mixing stations of metallurgical fuel gases):

$$\dot{E}_{CHP} = \dot{E}_{pr\ BFG} - \dot{E}_{CS} - \dot{E}_{MS} - \delta\dot{E}_{BFG} \quad (1)$$

The operation of installations consuming blast-furnace gas depends on random factors, which results in the randomness of the blast-furnace flux available for the CHP plant (Fig. 6). Also the LHV of blast-furnace gas ought to be considered as a random value.

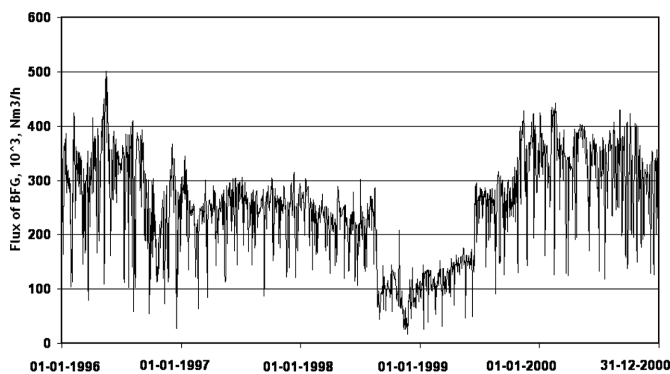

Fig. 6. Flux of BFG available for the CHP plant

The recovered LD converter gas (LDG) is accumulated in a storage tank in order to equalize the production and LHV of this gas. The CHP plant is the only consumer of this gas and therefore it may be assumed that the flux of chemical energy LDG is constant.

Another component of the gas mixture feeding the CHP plant is coke-oven gas. In the probabilistic approach (Monte-Carlo method) it has been assumed that it will be used to stabilize the LHV of the metallurgical fuel gas mixture in order to keep up the Wobbe index within the preset limits. In the approach based on the average value of BFG available for CHP plant it has been assumed that all the coke-oven and converter gas was burned in mixture with blast-furnace gas in order to achieve the highest possible LHV of the gas mixture. It has been assumed that the flux of the chemical energy of coke-oven gas supplied from outside is available on a given level. Such an assumption is justified in the further on considered example, because the coking plant is situated in immediate vicinity of the ironworks. Coke-oven gas is traditionally contained in fuel-gas mixtures firing industrial furnaces.

A metallurgical CHP plant is the main source of energy carriers feeding the technological processes. The investigated one consists of double-fuel boilers and three kinds of turbo-sets are turbo-generators, turbo-blowers and turbo-compressors. The thermal parameters of live steam: 9.8 MPa, 540°C. There are four extraction turbines (25 MW_{el} each) and one back-pressure turbine (50 MW_{el}). The back-pressure steam (0.07 MPa) is supplied to heat exchangers of the district heating system. There are two bleeds in the extraction turbines: process steam (0.8 MPa) and heating steam (0.12 MPa). The effective power rating of the turbine driving the turbo-blower amounts to 31 MW, and in the case of the turbo-compressor to 22 MW.

The demand for main technological energy carriers produced in CHP plants: flux of the blast – 380·10³ Nm³/h, compressed air to oxygen plant – 360·10³ Nm³/h. The average annual production of electricity – 550 GWh/a (it is about 40% of the electricity demand in the considered ironworks). The maximum demand for power amounts to 180 MW_{el}. Process steam is produced on two levels of pressure: 0.8 MPa and 3 MPa. The maximum fluxes of this steam are 120 t/h and 35 t/h, respectively. The maximum power of heat demand for district heating is 210 MW_t.

3. Statistical analysis of the availability of blast-furnace gas for the CHP plant

The flux of chemical energy of the blast-furnace gas available for the CHP plant depends both on the amount of its production and its LHV affected by the thermal parameters of the blast-furnace process and on the level of its consumption by the major consumers. Both the production of blast-furnace gas and its consumption are random values independent of each other. Thus, the flux of chemical energy of the blast-furnace gas available for the CHP plant is also a random value, for which, basing on statistical data, an empirical distribution function can be set up. The LHV of blast-furnace gas depends on the thermal parameters of the blast-furnace process, mainly on the share of oxygen in the enriched blast, the kind and amount of auxiliary fuels injected into the tuyère zone and the temperature of the blast. The randomness of the blast parameters allows to treat the LHV of the blast-furnace gas also as a random value for which the empirical distribution function may be determined basing on a set of statistical data.

Figs. 7 and 8 present empirical cumulative distribution functions of the flux of chemical energy of blast-furnace gas, as well as its LHV concerning the analyzed first period of five years, and also the representative average distribution function. In order to investigate the stability of the statistical distribution of the chemical energy of blast-furnace gas available for the CHP plant and its LHV, Kolmogorow-Smirnof's compatibility test has been applied [8]. The correspondence of each individual distribution function with the representative distribution function has been investigated. In Kolmogorow-Smirnof's correspondence test the deviation of the statistic λ_n from the boundary value was investigated. If on the given level of confidence $(1 - \alpha)$, we have:

$$\lambda_n < \lambda_\alpha \quad (2)$$

where

$$\lambda_n = D_{n_1, n_2} \sqrt{n} \quad (3)$$

$$n = \frac{n_1 n_2}{n_1 + n_2} \quad (4)$$

$$D_{n_1, n_2} = \sup |F_{n_1}(x) - F_{n_2}(x)| \quad (5)$$

the hypothesis of the assumed correspondence is true [8]. In Eqs. (3)÷(5) n_1 and n_2 denote the number of the investigated population and D_{n_1, n_2} is the measure of discrepancy between the investigated empirical distribution functions.

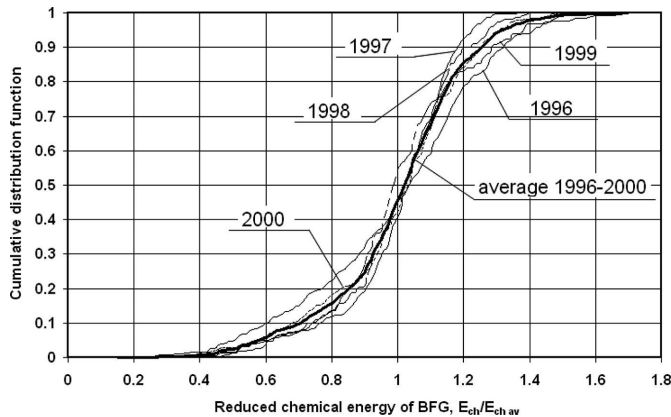

Fig. 7. Cumulative distribution functions of the BFG chemical energy flux

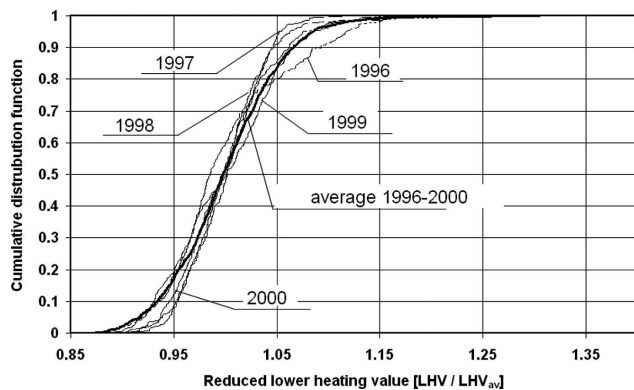

Fig. 8. Cumulative distribution functions of LHV of the BFG

In both cases reduced random values were used:

$$\frac{\dot{E}_{CHP}}{\bar{E}_{CHP}} \quad \text{and} \quad \frac{LHV_{BFG}}{\bar{LHV}_{BFG}}$$

where:

\dot{E}_{CHP} , \bar{E}_{CHP} – instantaneous and average flux of chemical energy of the blast furnace gas available for CHP plant,

LHV_{BFG} , \bar{LHV}_{BFG} – instantaneous and average LHV of blast-furnace gas.

In the considered cases the statistics of λ_n was contained within the range 0.37÷0.97 concerning the flux of chemical energy of the gas and 0.37÷1.21 concerning the LHV of blast-furnace gas. The boundary value on the level of significance $\alpha = 0.05$ amounts to $\lambda_\alpha = 1.36$. Hence, the conclusion arises that average distribution functions are in both cases representative and may be used to construct load duration curves of the flux of the chemical energy of blast-furnace gas and its

LHV applied in the probabilistic method of determining the optimal structure of repowering metallurgical CHP plants.

The empirical equations describing representative duration curves concerning the flux of the chemical energy of BFG available for the CHP plant and its LHV have the following form:

$$\frac{\dot{E}_{CHP}}{\bar{E}_{CHP}} = 29.628 \left(\frac{\tau}{\tau_0}\right)^6 - 116.62 \left(\frac{\tau}{\tau_0}\right)^5 + 171.04 \left(\frac{\tau}{\tau_0}\right)^4 - 120.5 \left(\frac{\tau}{\tau_0}\right)^3 + 42.547 \left(\frac{\tau}{\tau_0}\right)^2 - 7.4567 \left(\frac{\tau}{\tau_0}\right) + 1.6667 \quad (6)$$

$$\frac{LHV_{BFG}}{\bar{LHV}_{BFG}} = 16.156 \left(\frac{\tau}{\tau_0}\right)^6 - 55.492 \left(\frac{\tau}{\tau_0}\right)^5 + 73.638 \left(\frac{\tau}{\tau_0}\right)^4 - 47.691 \left(\frac{\tau}{\tau_0}\right)^3 + 15.643 \left(\frac{\tau}{\tau_0}\right)^2 - 2.5415 \left(\frac{\tau}{\tau_0}\right) + 1.1921 \quad (7)$$

where:

$\frac{\dot{E}_{CHP}}{\bar{E}_{CHP}}$ and $\frac{LHV_{BFG}}{\bar{LHV}_{BFG}}$ denote the relative value of the flux of the chemical energy of BFG available for the CHP plant and the relative value of its LHV; the average values \bar{E}_{CHP} and \bar{LHV}_{BFG} concern the considered set of statistical data; τ/τ_0 denotes the relative time.

In order to verify the empirical equations describing the representative duration curves of the flux of the chemical energy of BFG available for the CHP plant and its LHV, a new set of statistical data was used based on industrial information gathered in the years 2005÷2008 (Figs. 9 and 10). These diagrams present duration curves of the flux of the chemical energy of BFG available for the CHP plant and its LHV in the respective years. Besides, also the representative duration curves described by the Eqs. (6) and (7) have been presented. The representative duration curves evidently coincide well with the set of duration curves concerning the years 2005÷2008. This proves that the Eqs. (6) and (7) may be a useful tool in the prediction of the flux of the chemical energy of BFG and its LHV which is inevitable in thermoeconomical analyses of a CHP plant fired with BFG.

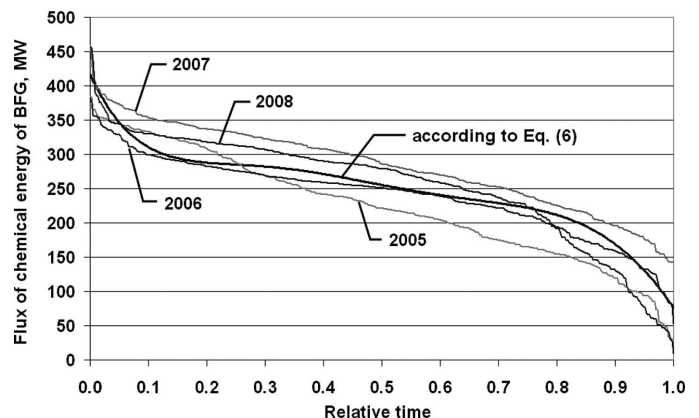

Fig. 9. Duration curve of the flux of chemical energy of blast-furnace gas available for CHP plant

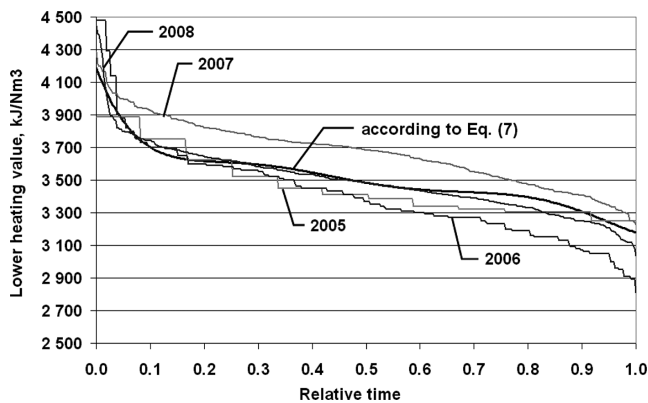

Fig. 10. Duration curve of blast-furnace gas LHV

4. Simulative optimization model of metallurgical CHP plant repowering

The existing traditional part of the considered metallurgical plant is shown in Fig. 11 together with the added gas part (marked by the balance cover shield) [9]. The parallel connection of the gas and traditional part of CHP plant is realized both in the gas fuel part as well as in the steam part [10].

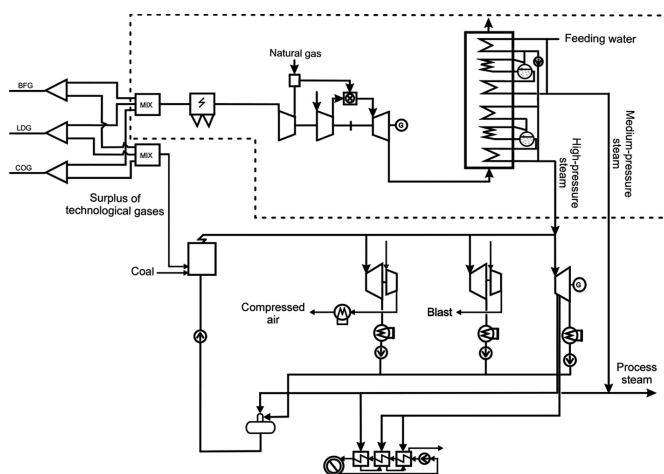

Fig. 11. Flowsheet of the repowered CHP plant

The algorithm of the choice of the optimal structure of repowering the metallurgical CHP plant is based on a large extent of probabilistic information:

- duration curve of the flux of chemical energy of the blast-furnace gas available for the CHP plant,
- duration curve of blast-furnace gas LHV,
- load duration curve of process steam,
- duration curve of ambient temperature.

Other input data comprise, among others:

- fluxes and LHV of converter gas and coke-oven gas,
- fluxes of live steam supplied to the turbo-blowers and turbo-compressors,
- information about the types of GT turbines available in the used data base software

are deterministic data.

Duration curves of the flux of the chemical energy of blast-furnace gas and its LHV were determined basing on the statistical analysis discussed in Section 3. The method of the choice of the power rating of a gas turbine fired with metal-

lurgical fuel gases differs from the way of choosing a turbine fed with natural gas, because the annual operation of GT is constrained not only by the demand for products (e.g. heat) but also by the supply of metallurgical fuel gases available for the CHP plant.

Due to the probabilistic character of some input information the Monte Carlo method has been applied in simulative calculations [11]. The application of the Monte Carlo method consists in multiple sampling of sets of input data determined by means of distribution functions of random values, such as the chemical energy of blast-furnace gas available for CHP plant, ambient temperature etc.

It has been noticed that the application of GT, conventionally fired with natural gas in order to utilize low-calorific metallurgical gases, affects its operation [12,13]. The following aspects of changing the fuel in the GT must be taken into consideration:

- an increase of the flow rate through the turbine leads to a higher pressure ratio in the air compressor which may cause its unstable operation,
- if low-calorific fuel is used, usually an increase of the power rating is observed; thus the admissible torque may be exceeded,
- a larger fuel flux affects the dimensions of the fuel supply system and thus also the costs of investments,
- after their processing technological fuel gases are saturated with humidity, which changes the conditions of heat transfer and leads to an increase of the temperature of the blades.

For this reason the following rules of modeling the GT have been assumed:

- the flux of flue gases leaving the GT must be kept constant by reducing the flow rate through the air compressor, making use of inlet guide vanes with a changing angle of inclination,
- the temperature of flue gases leaving the turbine must be kept constant,
- in the case of the determined fluxes of air and fuel gas the stability of operation of the air compressor must be checked (in order to avoid surging).

In the case of combusting low-calorific gases the following specific features of combustion are to be observed in comparison with natural gas:

- a narrow range of combustibility characterized by the upper and lower coefficient of air excess,
- slow combustion due to the high share of an inert component (N_2), involving its enrichment with some richer fuel.

Therefore the coefficient of air excess must be accurately controlled and a larger combustor must be applied.

A lower adiabatic temperature of combusting low-calorific gases ensures more favorable the characteristic of NO_x emissions. Therefore it is not necessary to inject water or steam into the combustion chamber. Practically the adaptation of standard GT in order to combust low-calorific metallurgical fuel gases consists in:

- designing an adequate combustion chamber,
- diminishing the flow rate through the air compressor by applying inlet guide vanes with a varying angle of inclination,

- restricting (in some cases) the temperature of the inlet to the GT in order to keep up the temperature of the blades within the permissible range.

The main assumptions concerning the determination of the optimal structure of a modernized CHP plants are as follows:

- the production of energy carriers for the needs of metallurgical processes remains unchanged, i.e. on the level of the existing CHP plant,
- the gas-and-steam part is introduced (Fig. 11) parallelly to the existing CHP plant fired with gas and hard coal; the main parallel connection between both parts will be the output steam; also on the side of feeding gaseous fuels a parallel connection is foreseen; the excess of BFG above the demand of GT will be combusted in gas and hard coal boilers, as so far,
- it is anticipated that the steam turbine island remains unchanged (4 extraction-condensing units with a power rating of 25 MW each and the back-pressure turbine with a power rating of 50 MW); also some gas and hard coal boilers fired mainly with hard coal will still be used, functioning, however, only as buffering consumers of surplus metallurgical fuel gases; the remaining part of hard coal boilers serves as a stand by,
- the designed combined cycle system replaces partially the existing CHP plant; in other words, some part of the gas and hard coal boilers will be replaced by HRSG; the electricity produced in the gas turbine replaces partially the supply of electricity from the electroenergy grid; thanks to the GT operation a larger production of electricity is expected, in comparison with the existing CHP plant,
- it has been assumed that a double-pressure HRSG, (9.0 and 0.8 MPa) will be applied and feed the existing steam collectors,
- the possibility of combusting additional rich fuel (natural gas) in HRSG has been taken into account, as the temperature of the combustion gases does not allow to achieve the required thermal parameters of live steam,
- the water feeding the HRSG will be supplied from the deaerators of the existing part of CHP plant,
- two blast-furnaces are assumed to operate, which determines the level of the mean available chemical energy of the BFG,
- the fluxes and composition of LDG and COG gases are assumed to be constant,
- the supply of natural gas used to enrich the gas fuel mixture is not limited (each determined flux of natural gas may be ordered and delivered to the CHP plant).

The mathematical model of CHP plant is based on substance and energy balances of the respective machines and equipment. It has been developed making use of Gate Cycle software [14]. The data base of Gate Cycle software contains technical characteristics of GT fired with natural gas. As mentioned above, the adaptation of a gas turbine fired with natural gas in order to utilize low-calorific gases (e.g. metallurgical fuel gases) requires some changes in its design and leads to changes of its main indices, such as the power rating of the turbine or the pressure ratio [12,13]. The necessity of these changes causes also an increase of capital investment costs compared with a gas turbine fired with natural gas.

The algorithm of determining the power rating of a gas turbine fired with low-calorific fuel comprises the following items:

- the Wobbe index of gaseous fuel (enriched mixture of technological fuel gases), as well as a specific model of the gas turbine determines the variant of repowering; a simulation model of the turbine is developed, using the technical data contained in the Gate Cycle data base; then the model is adjusted and its results are compared with those of the Gate Cycle standard GT model in the nominal operation point when GT is fired with natural gas; the Wobbe index is chosen within the range of 95÷175 MJ/kmol (the bottom limit corresponds to BFG, whereas the upper limit concerns LDG); basing on the balance of the mixing chamber of combustible gases the deficiency of metallurgical fuel gases supplemented with natural gas or the surplus of BFG to be supplied to the gas and hard coal boilers is determined, the demand for chemical energy of mixed gaseous fuels conditioned by the given type of GT,
- in the next step it is assumed that the turbine is fired with low-calorific gases; the same characteristic of the compressor is used in these simulations; it has been assumed that the flux and temperature of the flue gases leaving the gas turbine should be kept constant [15-17]; this assumption and the balance of the combustion chamber and the expander of the turbine permit to determine the fluxes of air and low-calorific fuel, as well as the temperature at the outlet of the combustion chamber; if due to the limited flux of air at the outlet of the compressor its operational point is situated in the zone of unstable operation (surging), the air flux must be increased in order to keep up an adequate safety distance from the surging line,
- further on the capacity of the gas compressor and dimensions of the heated surfaces of the recovery boiler are determined.

Besides *design-case* calculations concerning the operation in nominal conditions *off-design* calculations are carried out. Because of the variability of the flux of chemical energy of BFG the GT may be run with a load below the nominal one. Then, basing on the assumed characteristics of air and gas compressors their working points ensure that they operate within the range of stable work. In the case of a shortage of fuel gases at first a stable temperature of the combustion gases is kept up, reducing the flow rate through the air compressor by means of guide vanes and utilizing the entire available flux of metallurgical gases. If the stable work of the compressor is endangered, the flux of air is kept at the lowest required level, and natural gas is used to keep up the temperature of combustion gases at the outlet of the GT. If the gas compressor operates in the unstable range, the GT is shut down.

Both in the *design* and *off-design* case calculations, the composition of the fuel gas mixture is chosen in such a way that first the low-calorific metallurgical fuel gases are combusted as much as possible. Natural gas is applied later.

The optimization part of the model bases on the method of reviewing the permissible solutions. The objective function is the Net Present Value [18], in which the main items are:

- net income results from the increase of sale of electricity after repowering the CHP plant

$$S_n = k_{el} \left(\int_0^{\tau_a} N_{el\ rep} d\tau - E_{el\ exist} \right) \quad (8)$$

- change of costs due to the change in the consumption of the chemical energy of fuels

$$\Delta K_E = k_c \left(\int_0^{\tau_a} \dot{E}_{ch\ c\ rep} d\tau - E_{ch\ c\ exist} \right) + k_{ng} \int_0^{\tau_a} \dot{E}_{ch\ ng\ rep} d\tau \quad (9)$$

- main part of the change in environmental costs is the result of a change in consumption of coal

$$\Delta K_{eco} = \frac{\Delta E_{ch\ c}}{LHV_c} k_{eco\ c} \quad (10)$$

- capital investment comprises the following items

$$J = J_{gas\ prep} + J_{GC} + J_{GT} + J_{HRSG} + J_{pip} \quad (11)$$

After the utilization of probabilistic information by Monte-Carlo random sampling, the simulations of the re-powered plant are performed for each sampled set of inputs. The results of plant simulations are input values for the analysis of the economical effectiveness of re-powering. The modernized variant with the best economical performance is the optimal solution.

5. The choice of the optimal structure of a modernized CHP plant

The presented algorithms have been applied in both analyses aiming at the choice of an optimal structure of a modernized CHP plant. The range of modernization comprises the addition of the gas-and-steam unit, consisting of the mixing station of fuel gases, the gas cleaning system, the gas compressor, the GT system and HRSG. The scheme of this modernized CHP plant is to be seen in Fig. 11 concerning both cases. The structure of the power plant is determined by the components of the system, the connections existing between them and the structural parameters of the incorporated devices.

In the analysis the decision variables were: the power rating of the gas turbine and the Wobbe index of the gas mixture supplying the combustion chamber. Table 1 presents the selected parameters of the gas turbines considered in the analysis as possible variants of modernization.

The operation of the gas turbine is determined by the Wobbe index (correlated closely with the LHV) of the gaseous fuel. The lower the Wobbe index, the higher is the flux of the fuel, which results in a higher decrease of the flow through the air compressor. This causes that the compressor operation point is far from the nominal one and the efficiency of the compressor and whole gas turbine drops (if compared with the use of natural gas). The lower the LHV of the fuel, the lower is also the efficiency of the turbine. An increase of the Wobbe index of mixed fuel gases involves a lower dependence of the system on the availability of BFG. In such a case a lower flux of BFG is available for a longer time during the year and warrants a better utilization of the nominal power rating of GT. An increase of the Wobbe index decreases the capacity of the installation preparing the fuel gas mixture (electrical precipitator and gas compressor), and thus also leads to a reduction of the investment costs. On the other hand, however, this effects a higher consumption of natural gas and an increase of the operation costs due to the considerable price of natural gas. The range of variation of the power rating of GT, considered as variants of modernization, is determined by GTX100 with a nominal power rating of 43 MW permitting the utilization of only a third part of the average flux of low-calorific metallurgical fuel gases. This is the bottom level of the GT set. The upper level is GT13D with a nominal power rating of 98 MW. Its application permits to utilize the average flux of the chemical energy of metallurgical fuel gases. In the case of such a power rating the influence of the restriction of the supply of fuel gases on the energy characteristics of GT operation becomes distinct. The considered decision variables determine the structure of the CHP plant because they affect the power of the gas compressor and heat recovery steam generator.

Fig. 12 presents a diagram of the net nominal power rating of the GT-gas compressor unit fired with a mixture of low-calorific gases (ISO conditions). The power rating of the GT itself grows slightly if low-calorific fuel gases are used (reduction of the air flux due to the assumption that the flux of flue gases is constant), but the necessity of compressing the gases leads to a decrease of the power rating of the system if compared with GT fired with natural gas. Fig. 13 shows the dependence of the efficiency of electricity production on the considered variant. The effect of decreasing the efficiency results in the case of low-calorific gases, compared with natural gas conditioned by keeping up the temperature of flue gases after leaving the GT on a constant level (the higher share of diatomic gases in combustion gases leads to a decrease of the expansion line in the GT).

Parameters of analysed gas turbines [15,16]

TABLE 1

GT model	–	GTX100	GT8C	V64.3	PG6101	PG7111EA	GT13D
Producer	–	ABB	ABB	Siemens	GE	GE	ABB
Power rating	MW	43.14	52.9	63.2	70.05	83.7	97.85
Efficiency	%	37.1	34.4	35.2	34.25	32.55	32.3
GT exhaust outlet temperature	°C	547	520	532	598	531	490

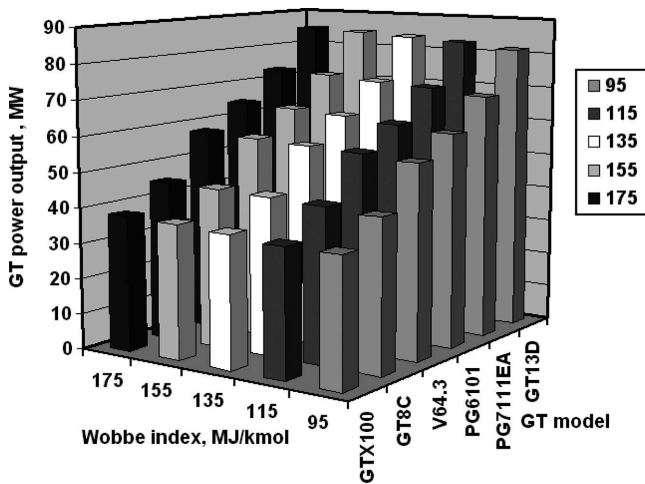

Fig. 12. Power rating of the unit

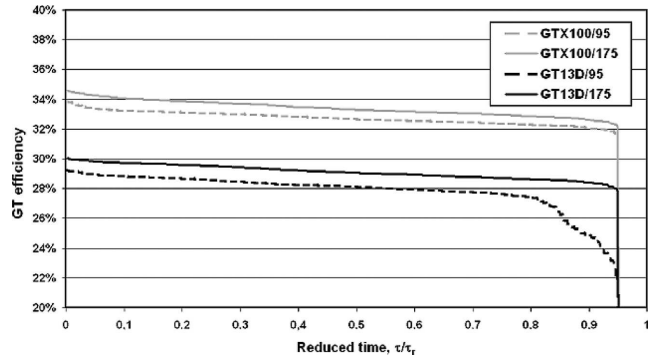

Fig. 14. Duration curves of GT efficiency

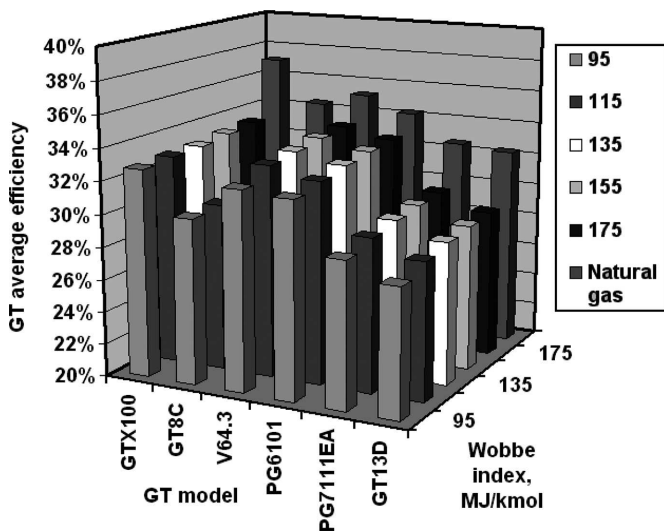

Fig. 13. Average annual efficiency of the GT fired with low calorific fuel

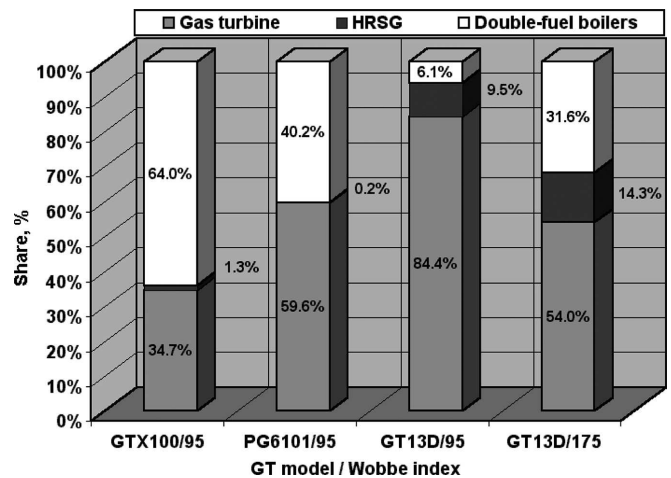

Fig. 15. Shares in utilisation of technological fuel gases

A simulative analysis of the plant operation has been carried out for a number of input sets obtained from the Monte Carlo method. This causes that the results are quoted in the form of statistical distributions of operational parameters. In the case of a bigger gas turbine, utilizing a gas mixture with the Wobbe index amounting to 95 MJ/kmol, the character of the distribution is different from the others (Fig. 14). This is caused by the shortage of gas fuel, which can be avoided by applying a smaller gas turbine or when the enrichment of the blast furnace gas is higher. In Fig. 15 a decreasing share of double-fuel boilers can be observed at an increasing power rating of the gas turbine. A higher enrichment of the BFG gas results in a longer operation of the GT, but also causes that the share of utilization of less efficient steam boilers increases.

Fig. 16 presents the results of the production of electricity, obtained thanks to repowering. A characteristic feature is the growing increase of electricity production with the growing Wobbe index. This effect is higher in the case of a higher power rating of GT. This results from the time of operation with a nominal power rating growing with the Wobbe index. Fig. 17 presents the annual consumption of natural gas in a modernized CHP plant. With the increasing power rating of GT and Wobbe index the annual consumption of natural gas required to enrich the fuel gas mixture grows, too. Only in the case of the smallest GT the enrichment of the mixture to the Wobbe index 115 kJ/kmol does not require natural gas consumption (for its enrichment COG and LDG are sufficient). Fig. 18 illustrates the quantities of the increment of hard coal consumption depending on the GT power rating and Wobbe index. In the case of low Wobbe indexes an increase of the GT power rating means a reduction of the amount of metallurgical fuel gases for double-fuel boilers and an increase of hard coal consumption. A higher Wobbe index indicates an increase of natural gas consumption and a growing surplus of low-calorific fuel gases for double-fuel boilers. The annual increase of power production, the annual natural gas consumption and change of the consumption of coal are input values in the analysis of the economical effectiveness of modernization.

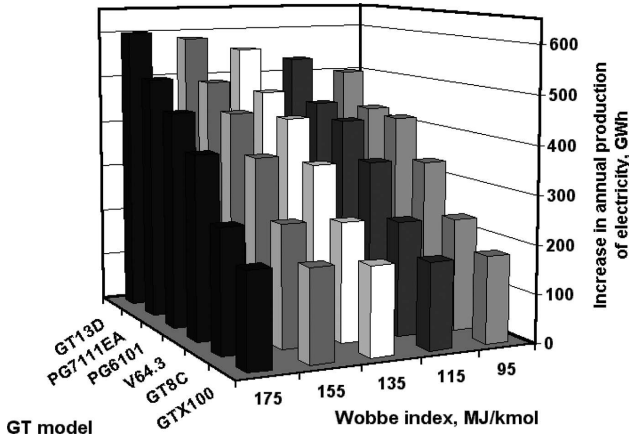

Fig. 16. Increase in annual CHP's production of electricity

implies that the enrichment of BFG gas by means of natural gas is in the considered conditions not profitable, increasing the costs because of the high unit price of natural gas. Fig. 20 presents the discounted pay-back time for the considered variants of modernization. The investment costs are repaid after 6.6 years. The corresponding IRR amounts to 23.3%. Among the investment costs the highest item is the GT and gas compressor (about 55%). Also the costs of the installation and pipelines are a considerable item (~33%). The investments for HRSG constitute 10÷12% of the total costs. The structure of investment costs depends on the power rating of GT only in a small degree [9].

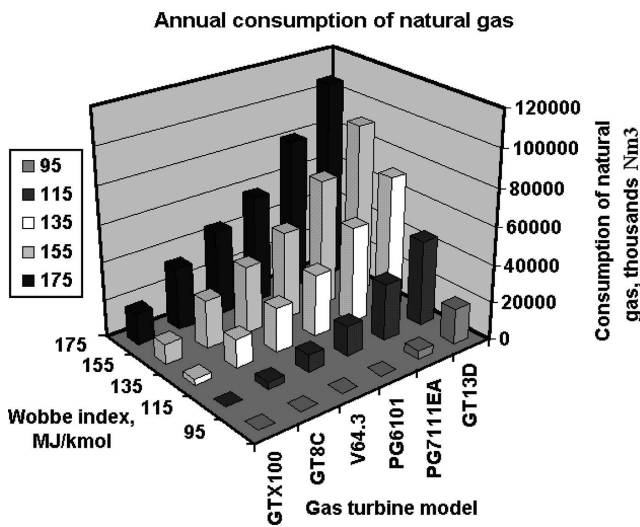

Fig. 17. Annual consumption of natural gas within CHP plant

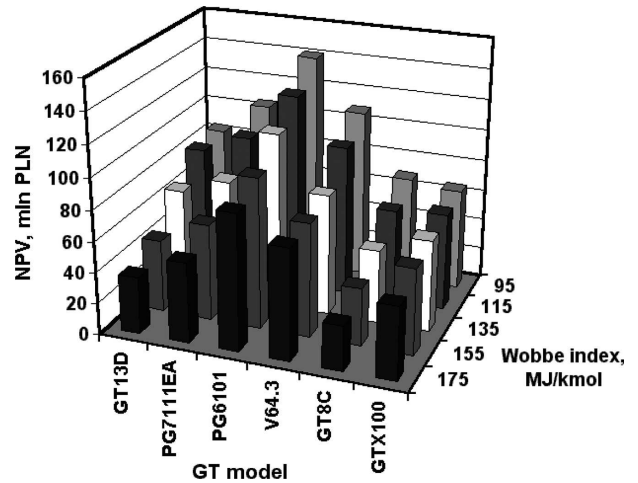

Fig. 19. Net present value of modernisation of CHP plant

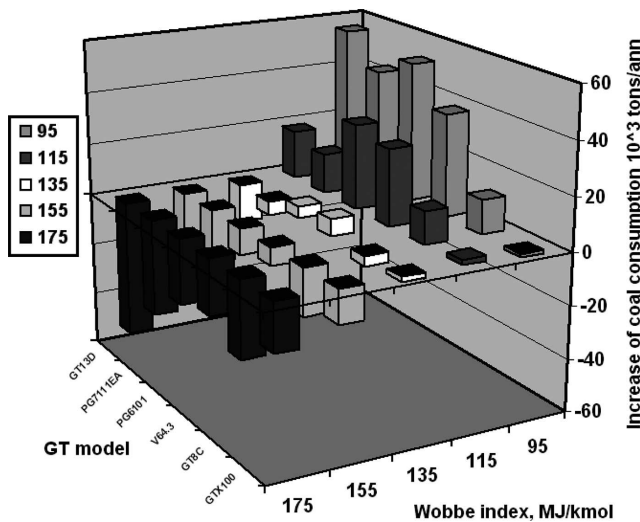

Fig. 18. Increase of the annual hard coal consumption within CHP plant

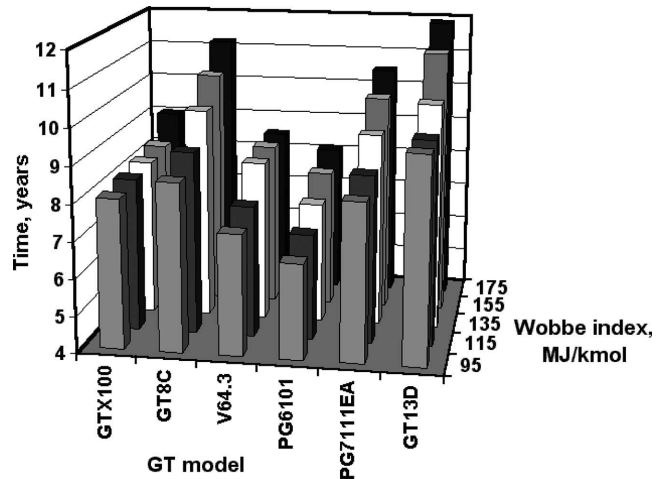

Fig. 20. Discounted pay-back time of the venture

Fig. 19 presents the results of the economical analysis of the considered variants of modernization. In the economical assumptions the achieved discount rate of cash flows amounts to 5.42%. The highest NPV is achieved in the case of the turbine PG6101 and the lowest considered Wobbe index. This

The sensitivity analysis has shown that the highest influence on the objective function is exerted by the price of electricity. Important is also the accuracy of assessing the investment costs. The price of hard coal depends on the increment of its consumption differing in various variants. This effect displays opposite trends if the consumption of hard coal decreases (negative increment). The influence of the price of natural gas is distinctly important when the power rating of GT and the Wobbe index are higher, in which case the consumption of natural gas is considerable.

6. Choosing the optimal structure of repowering metallurgical CHP plant

In practical designing the choice of the energy structure of CHP plant is usually based on a set of input data, which are annual mean values. The duration curve of ambient temperature is used to determine the average temperature in the heating and off-heating season. Comparative calculations, basing on average data, have shown that the fundamental values determined by means of optimization differ from the results of the probabilistic model only slightly [9]. Thus, for instance, in the case of the power rating of a gas turbine differs by 1.2%. As far as the production of electricity is concerned, this difference amounts merely to 0.3%. Although the results concerning the discounted pay back time differ by about 9%, in this case we must keep in mind that the economical input values are characterized by a considerable uncertainty. Larger differences are encountered only in the assessment of the consumption of natural gas (mainly used to stabilize the LHV of the fuel gas mix) and the consumption of hard coal (combusted in double-fuel boilers). This did not influence, however, the basic result of optimization, i.e. the choice of the power rating of the gas turbine. In both cases the result of the optimizing analysis is the same (PG 6101 gas turbine from General Electric).

The obtained results of the comparative analysis of both mentioned approaches to optimization motivate the verification of the results of choosing the structure of a modernized metallurgical CHP plant. For this purpose new information has been gained and on its base optimizing calculations have been carried out, making use of the model, applying average input data.

In the verifying analysis a new mathematical model of the combined cycle of the CHP unit was developed, making use of two kinds of commercial software:

- the existing CHP unit was designed by means of the program Engineers Equation Solver (EES),
- the gas turbine and heat recovery steam generator (HRSG) performed in the program Thermoflex.

The program concerning to the existing part is based on implemented equations describing the individual elements of the system by means of mass and energy balances. On the other hand, the program Thermoflex is based on built-in models and databases (as in the Gate Cycle software). For a proper operation of both these programs it is necessary to determine the parameters at the characteristic points of the CHP unit model [19], including steam pressure in the turbine bleeders, temperature limitations in the heat exchangers, nominal efficiencies etc. Those data have been updated in comparison to

the data used in previous analyses. Also, specific dependences concerning metallurgical CHP plant have been included in the mathematical model, as the change in the boiler efficiency depending on the ratio of the blast-furnace gas in the total chemical energy of the fuel burned in the boiler. The proper operation of the developed mathematical model is controlled by procedures implemented into the EES program. They are responsible for the regulation of flows and temperatures in the steam-water cycle depending on the ambient temperature (in the given season). In order to implement the heat demand for the heating systems in the mathematical model, the dependence of the temperature of hot and return water on the ambient temperature has been taken into account. Also, as previously (basing on average values), the availability of the chemical energy of blast-furnace gas was assumed to be an average value [19].

The coupling of those two models consists in exchanging the data between them, including steam flows on both pressure levels from the HRSG to the collectors of the existing part of the CHP unit, the consumption of low-calorific gases in the gas turbine, and so on.

In the verifying analysis the decision variable was the power rating chosen from the set of nine gas turbines taken from the built-in Thermoflex software database. A special design mode was used, which allows later to determine the total investment costs more accurately for all elements of the added part. Table 2 presents selected parameters of the gas turbines considered in the analysis as possible variants of modernization.

The total investment costs were taken from the Thermoflex program database [19]. They were in the range from 115.3 (GE 651B) to 260.2 millions PLN (GE LMS 100PA). The division of the cost between the parts of the gas cycle unit was similar in all cases and amounted to about 60% for a modernized gas turbine, about 20% for the gas compressor and heat recovery steam generator each. About 3% of investment costs were assigned for the gas purification unit.

The results obtained in the economical analysis [19] are similar to the previously presented probabilistic approach based on the Monte Carlo method [9]. The investment costs are returned in all cases and provide positive values of NPV in the range from 150 (GT8C2) to over 300 millions PLN (GE 6111FA). Thus, the gas turbine GE 6111FA was chosen as an optimal solution. Here it should be stressed that the GT 6111FA constitutes the same series of types as the GT PG6101, chosen as the optimal one in the analysis applying the Monte Carlo method.

TABLE 2

Parameters of analysed gas turbines [19]

GT model	-	GE 6581B	GE 6591C	SGT-800	SGT-900	GT8C2	SGT-1000F	V64.3A	GE 6111FA	GE LMS 100PA
Producer	-	GE	GE	Siemens	Siemens	Alstom	Siemens	Ansaldo	GE	GE
Power rating	MW	42.1	42.9	47.0	49.5	56.5	67.4	75.0	78.3	98.5
Efficiency	%	32.2	36.4	37.5	32.9	34.3	35.3	35.9	35.7	45.1
GT exhaust outlet temperature	°C	546	568	544	514	508	583	574	594	417

7. Conclusions

The application of gas-and-steam CHP plants permits to utilize more effectively the chemical energy of metallurgical fuel gases in comparison with the traditional utilization of these gases in double-fuel boilers. A characteristic feature of these gases is the changeability of the flux and LHV of blast-furnace gas available for the CHP plant. Therefore, the input data concerning the supply of such gases are of probabilistic character. In the considered case representative diagrams have been developed concerning the duration curves of the reduced flux of the chemical energy of BFG and its LHV, basing on a set of operational data of 5 years. Kolmogorow-Smirnoff's test has been applied to determine the stability of statistical distribution. The presented duration curves were confirmed in the verification analysis, proving them to be a good tool for predicting the availability of blast furnace gas in the coming years. Further probabilistic information is provided by the duration curve of ambient temperature and the duration curve of the demand for process steam.

An important part of the analysis of the gas-and-steam system is devoted to the gas turbine (GT). Available catalogue data concern GT's fired with natural gas. This requires the development of a method permitting to pass over from natural gas GT to gas turbines fired with a mixture of low-calorific metallurgical gases. This method has been applied in the algorithm of repowering a metallurgical CHP plant.

The Monte Carlo method was applied in simulative calculations due to probabilistic input information. The results of simulations of the operation of a CHP plant before and after its modernization (repowering) provided input data for an economical analysis. The objective function of such an optimization was the NPV. The method of optimizing the structure of a modernized CHP plant consisted in reviewing the set of possible solutions within a definite range of decision variables.

The main aim of the paper is to optimize the structure of a modernized CHP plant making use of input data in the form of duration curves. The application of probabilistic information permits to obtain more adequate results of calculations, but in the case of an analysis based on average values the fundamental values determined by the approach based on average data differ from the results of the probabilistic model only slightly.

The maximum of NPV (objective function) was achieved by applying a PG6101 turbine produced by General Electric and determining the Wobbe index of the fuel mixture on its lowest level. The application of the Gate Cycle program in calculations complying with the first set of input data (1996-2000) and of the data from 2005-2008, applied in calculations based on Thermoflex and the Engineering Equation Solver provide similar results in the choice of the structure of a repowered metallurgical CHP plant fired with technological fuel gases. Both analyses indicate an unfavorable effect of applying natural gas as a component enriching low-calorific gases, because its price is rather high for industrial consumers in Polish conditions. Summarizing, the obtained DPB indices (in the optimal variant of 6.6 years) show that the considered modernization of a metallurgical CHP plant to a gas and steam cycle is profitable.

Acknowledgements

Partially this paper was elaborated within the frame of the grant No NR 06 0004 06/2009 "CHP STRATEG" supported by the Polish Ministry of Science and High Education and the National Centre for Research and Development, for which the Authors wish to express their gratitude.

REFERENCES

- [1] A. Ziębik, Thermoeconomic problems of Metallurgical Combined Heat-and-Power Plants. Proceedings of ECOS 2001, Istanbul.
- [2] B. Bieda, A. Henclik, J. Kulczycka, Life cycle assessment in the energy generation process – variant analysis in metallurgical industry. Archives of Metallurgy and Materials **55**, 4 (2010).
- [3] R. Kehlhofer, Combined-Cycle Gas and Steam Turbine Power Plants. Fairmont Press Inc. USA 1991.
- [4] H. Takano, Y. Kitauchi, H. Hiura, Design for the 145-MW Blast Furnace Gas Firing Gas Turbine Combined Cycle Plant, Transactions of the ASME **111**, April 1989.
- [5] J. Mulder, P. Havennar, D. Santen, Blast-Furnace Gas Cuts Costs at Ijmond1, Modern Power Systems, September 1996.
- [6] G. Thoraval, S. Simonetti, E. Malusardi, Blast-Furnace Gas: an Incentive for Italy. Power Engineering, **5**, 1998.
- [7] A. Ziębik, M. Warzyc, Effectiveness of the utilization of technological low calorific gaseous fuels in an industrial combined gas-and-steam cogeneration plant. Proceedings of the ECOS 2002, Berlin, Germany, volume II.
- [8] S. Ostasiewicz, Z. Rusnak, U. Siedlecka, Statistic-Elements of Theory and Exercises. Academy of Economy, Wrocław 1995 (in Polish).
- [9] M. Warzyc, Choice of the optimal structure of gas and steam CHP fired with the metallurgical fuel gases. PhD dissertation, Gliwice, 2003 (in Polish).
- [10] A. Ziębik, M. Warzyc, Repowering of Metallurgical CHP Plants Fired with Hard Coal and Low-Calorific Fuel Gases. Proceedings of the ECOS 2004, Mexico.
- [11] A. Dubi, Monte Carlo Applications in Systems Engineering, John Wiley & Sons Ltd, New York, USA 2000.
- [12] F.J. Brooks, GE Gas Turbine Performance Characteristics, GE Power Systems GER-3567H.
- [13] E. Jeffs, Baoshan Combined Cycle Running on Blast-Furnace Gas. Turbomachinery International 2/1998.
- [14] GateCycle 5.40, GE Enter Software.
- [15] T. Chmielniak, A. Rusin, K. Czwiercniak, Gas Turbines. Ossolineum, Wrocław 2001 (in Polish).
- [16] Gas Turbine World – Handbook (for Project Planning, Design and Construction) **18**, 1997.
- [17] A. Miller, J. Lewandowski, Gas-and-Steam Systems Fired with Solid Fuel, WNT, Warszawa 1993 (in Polish).
- [18] A. Bejan, G. Tsatsaronis, M.J. Moran, Thermal Design and Optimisation. J. Wiley & Sons Ltd, New York, 1996.
- [19] P. Gładysz, Thermoeconomical analysis of repowering a metallurgical CHP to a high-efficiency combined cycle CHP unit. MSc thesis. Silesian University of Technology, Gliwice, 2010 (in Polish).