

AN IDEA OF A MEASUREMENT SYSTEM FOR DETERMINING THERMAL PARAMETERS OF HEAT INSULATION MATERIALS

Stanisław Chudzik, Waldemar Minkina

Częstochowa University of Technology, Institute of Electronics and Control Systems, Armii Krajowej 17, 42-200 Częstochowa, Poland (chudzik@el.pcz.czest.pl, minkina@el.pcz.czest.pl +48 34 325 0819)

Abstract

The article presents the prototype of a measurement system with a hot probe, designed for testing thermal parameters of heat insulation materials. The idea is to determine parameters of thermal insulation materials using a hot probe with an auxiliary thermometer and a trained artificial neural network. The network is trained on data extracted from a nonstationary two-dimensional model of heat conduction inside a sample of material with the hot probe and the auxiliary thermometer. The significant heat capacity of the probe handle is taken into account in the model. The finite element method (FEM) is applied to solve the system of partial differential equations describing the model. An artificial neural network (ANN) is used to estimate coefficients of the inverse heat conduction problem for a solid. The network determines values of the effective thermal conductivity and effective thermal diffusivity on the basis of temperature responses of the hot probe and the auxiliary thermometer. All calculations, like FEM, training and testing processes, were conducted in the MATLAB environment. Experimental results are also presented. The proposed measurement system for parameter testing is suitable for temporary measurements in a building site or factory.

Keywords: thermal conductivity, artificial neural networks, inverse heat conduction problem.

© 2011 Polish Academy of Sciences. All rights reserved

1. Introduction

The market of building materials reveals significant and increasing demand for various types of heat insulating materials. Most often they are foamed polystyrene panels, unwoven fabrics and mats made of foamed polyurethane or mineral wool [1]. The thermal quality of these materials is usually determined using the contact method with a panel apparatus. However, this method allows only for determination of the thermal conductivity and requires, in laboratory conditions, large and heavy measurement systems as well as relatively long measurement time.

Therefore, efforts are made to develop measurement systems without such limitations [2]. Research concentrates, among others, on application of artificial neural networks to solving, for selected models of measurement setups, the coefficient inverse problem of heat diffusion that employs the nonstationary heat flow theory [3].

2. Thermal probe method

The presented idea of a measurement system is based on using a thermal probe that could be plunged into a soft heat insulating material. Probes operating as linear heat sources are typically used for measurements of the thermal conductivity of loose materials and viscous fluids [4-11]. A thermal probe is at the same time a heater (a linear heat source) and a thermometer that measures the temperature of a sample at a certain distance from the installed heater or the heater temperature itself. The structure of commonly used heat insulating

materials, like mineral wool or foamed polystyrene (more than 90% of their porous structure is filled with gas), makes it possible to plunge a thin needle-shaped probe without any damage.

In the classic „hot wire” method [5, 6, 10], a linear thin wire heater is placed in a suitably prepared sample whose initial temperature T_0 is constant. Next, at instant $t = 0$, the heater is fed for a short period from a constant power electric supply and the temperature rise of the heater during this heating stage is recorded. The mathematical model of the process is based on solution of the heat diffusion equation in the cylindrical coordinate system:

$$\frac{\partial^2 T}{\partial r^2} + \frac{1}{r} \frac{\partial T}{\partial r} = \frac{1}{a} \frac{\partial T}{\partial t}, \quad (1)$$

with the following initial and boundary conditions:

$$\begin{cases} t = 0 & r > 0 & T = T_0 = 0 \\ t > 0 & r \rightarrow \infty & T = 0 \\ t > 0 & r \rightarrow 0 & -2\pi r \lambda \frac{\partial T}{\partial r} = q' = \text{constant}, \end{cases} \quad (2)$$

where: a – thermal diffusivity, λ – thermal conductivity, q' – power of the linear heat source.

There are several variations of the hot wire method. Mathematical models of all of them are based on equation (1), the differences lie in how the temperature is measured [5, 6, 11]. Techniques of temperature measurement in this method were standardized in 1978 by the DIN 51046 Standard-Part 2 and e.g. in [12, 13, 14]. The solution of equation (1) is temperature rise $T(t)$. The thermal conductivity is evaluated using the following approximate expression [5]:

$$\lambda = \frac{-q'}{4\pi T(t)} E_i \left(\frac{-\rho c_p r^2}{4\lambda t} \right), \quad (3)$$

where: λ – material thermal conductivity W/(mK), q' – linear density of the delivered thermal power, W/m, ρ – material mass density, kg/m³, c_p – material specific heat, J/(kgK), r – distance between the hot wire and the thermocouple, m, t – time from the start of the heating, s, $T(t)$ – rise of the thermocouple temperature, K, $E_i(-x)$ – integral exponential function.

To solve mathematical model (3) we assumed that the heat source is ideally linear: the mass, thermal capacity and diameter of the heater tend to zero, and its length tends to infinity. Besides, it was assumed that the material sample is of infinite size.

Summing up, we can state that known thermal probe techniques for evaluation of the thermal conductivity use simplified the relationships derived on the basis of the Fourier equation [4-11]. These techniques do not ensure accurate results. In the case of heat insulating materials with relatively a small product ρc_p , J/(K·m³), and the thermal capacity of the sample comparable with the thermal capacity of the probe, such far reaching simplifications of the phenomenon mathematical model should not be assumed.

3. A new idea of a hot probe measurement system

The presented idea of a measurement system is based on a thermal probe plunged into a soft sample of the heat insulating material under test (Fig. 1). Probes operating as linear heat sources are used usually for measurements of the thermal conductivity of loose materials and viscous fluids [4, 5, 8, 9, 12, 14]. In the case of such heat insulating materials like mineral

wool or foamed polystyrene, more than 90% of their porous structure is filled with gas, which makes it possible to plunge a thin needle shaped probe without damage.

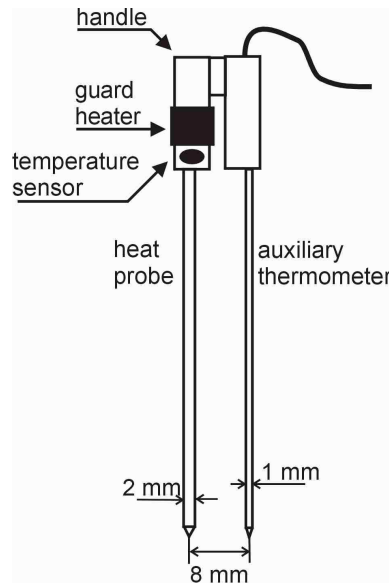

Fig. 1. Predesign of thermal probe

The proposed idea of a measurement system provides the possibility of measuring three basic thermal parameters, i.e. thermal diffusivity a , m^2/s , thermal conductivity λ , $\text{W}/(\text{m}\cdot\text{K})$ and specific heat c_p , $\text{J}/(\text{kg}\cdot\text{K})$. These parameters are related with each other by the relationship:

$$a = \frac{\lambda}{\rho \cdot c_p}, \quad (4)$$

so it is sufficient to evaluate two of them. To obtain this we assumed that the measurement system records the rise of the hot probe temperature T_G as well as rise of temperature T_D inside the sample 8 mm away from the symmetry axis of the probe. Taking into consideration in the model the presence of the probe handle is difficult. Boundary conditions on surfaces of the handle depend on ambient conditions and are generally not predictable in real measurements. To eliminate this undesirable effect, which is an additional source of measurement error, we applied compensation of the thermal probe handle: a guard heater with a temperature sensor – Fig. 1.

4. Mathematical model of the phenomenon

To model the heat diffusion process in a material sample with a complete measurement probe plunged into it, we developed a two dimensional mathematical model based on the general Fourier-Kirchhoff equation:

$$\rho c_p \frac{\partial T}{\partial t} - \nabla \cdot (\lambda \nabla T) = Q, \quad (5)$$

where: Q – volume output of a heat source, ∇ – vector nabla operator.

The half cross-section of the symmetric part of the sample with a measurement probe was modeled in a XY coordinate system. Placing a real thermometer in the structure of an object under investigation always results in some distortion of the temperature field, so the

temperature indicated by such a thermometer is not always the true temperature in the object [15, 16]. Therefore, in our research, we took into consideration both a model of the thermal probe and a model of the auxiliary thermometer.

The discretization mesh of the modeled sample is presented in Fig. 2. The temperature distribution with time for each node of the model mesh was evaluated using the finite element method (Fig. 3 and Fig. 4).

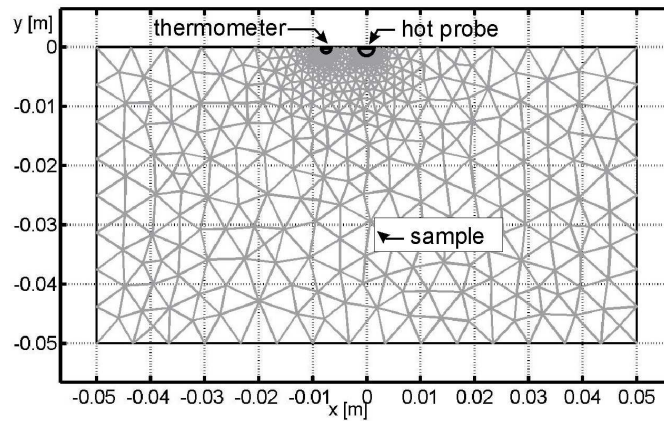

Fig. 2. The half section of the sample with the thermal probe and its discretization mesh.

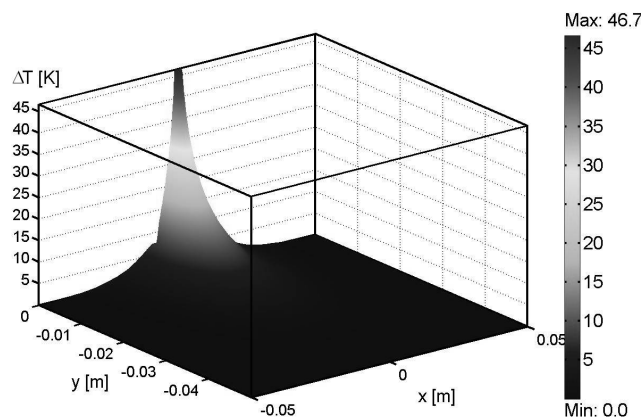

Fig. 3. The temperature profile of the sample after 100 s for the probe with auxiliary thermometer

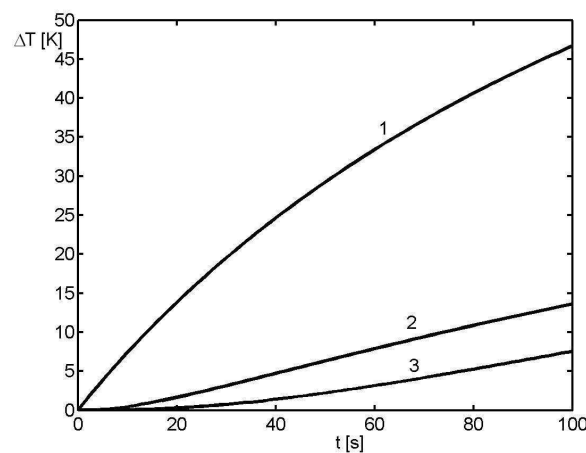

Fig. 4. Changes in temperature of the probe (1), non-disturbing (ideal) auxiliary thermometer (2) and real auxiliary thermometer (3) placed at a distance of 8 mm from the probe

Besides, we modeled the half cross-section of the symmetric part of the sample with an inhomogeneous (multi-layer) thermal probe (also in the XY coordinate system) – Fig.5

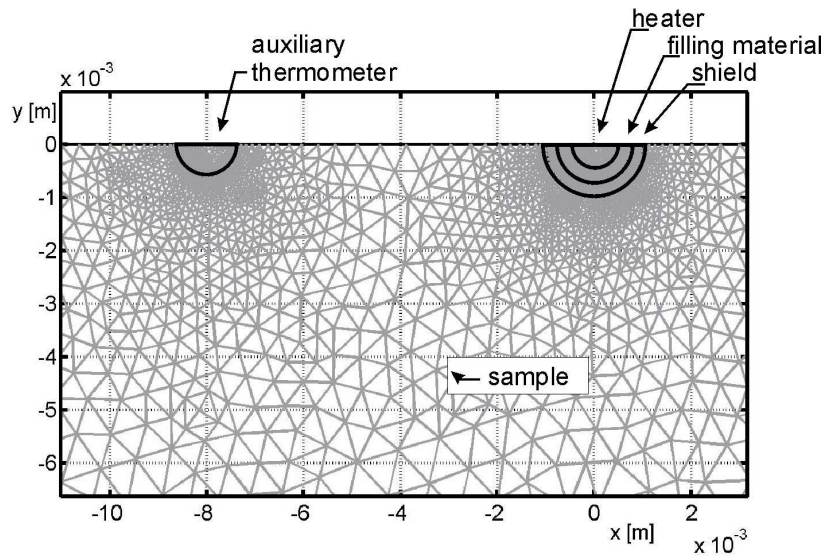

Fig. 5. The half section of the sample with a multi-layer thermal probe and corresponding discrete mesh

Fig. 6 shows the temperature rise of the heater, the probe filling material, the shield and the real auxiliary thermometer plunged in the sample 8 mm away from the probe axis.

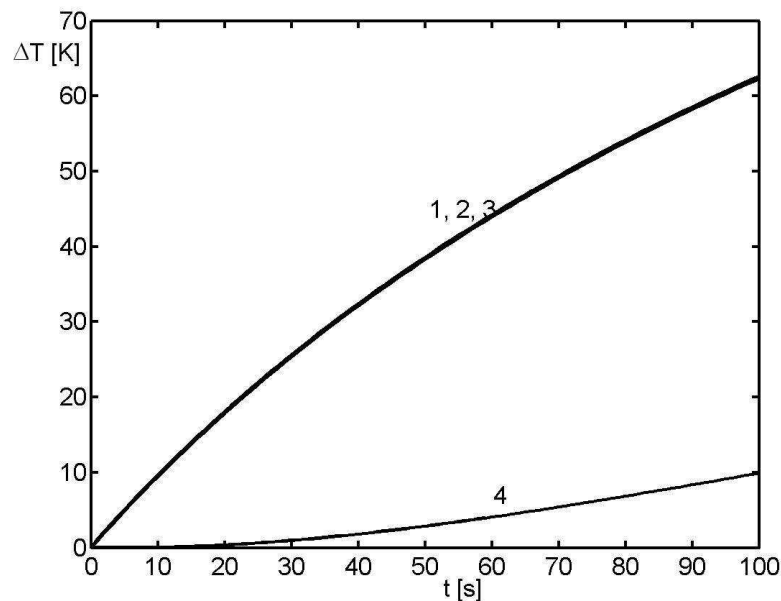

Fig. 6. Changes in temperature of the probe parts: heater (1), filling material (2), shield (3) and real auxiliary thermometer (4) placed at a distance of 8 mm from the probe

In the case of such a specific measurement method like the one presented here, it is necessary to investigate how the probe handle affects the temperature field inside it. Moreover, in our simulations we also investigated boundary effects resulting from finite geometric dimensions of the sample. The thermal probe with the handle plunged into the sample of heat insulating material, were modeled in the three dimensional rectangular coordinates as a symmetric quadrant sector and discretized into a mesh of finite elements as presented in Fig. 7.

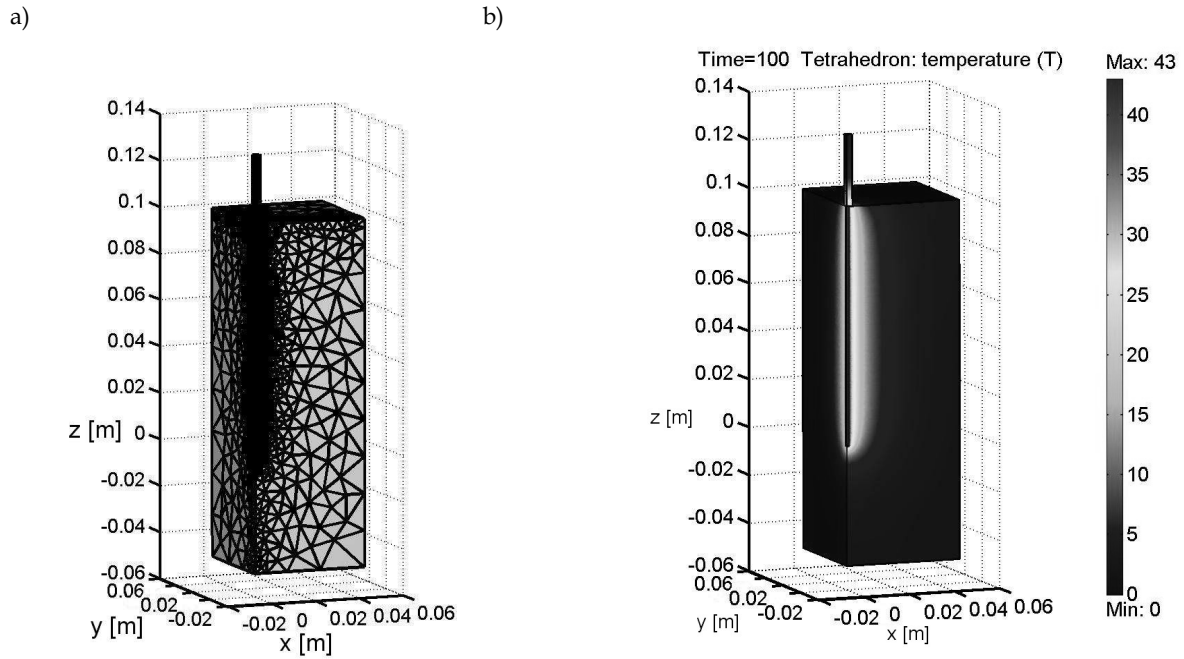

Fig. 7. Quadrant of the symmetrical model of the probe with handle in the XYZ co-ordinates: discrete mesh (a), temperature field after 100 s (b)

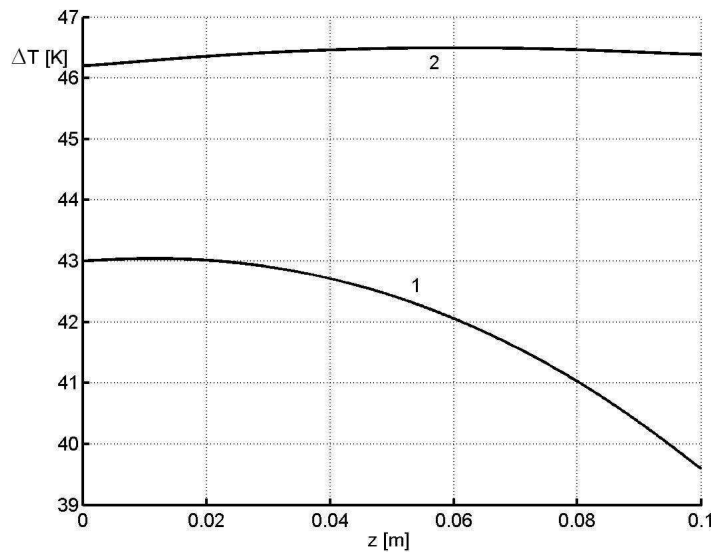

Fig. 8. Changes in temperature along the Z-axis after 100 s: probe with handle (1), probe without handle (2)

Fig. 8 shows graphs of the temperature rise along the symmetry axis of the probe with (1) and without the handle (2) after 100 seconds of heating. These results show clearly that the presence of the handle has a significant effect on temperature distribution inside the probe. This thermal effect has to be compensated.

5. Application of neural network to solve the inverse problem

The algorithm for evaluation of material thermal parameters from solution of the direct heat diffusion problem and optimization of the mean squared error was presented in detail in previous works [3]. However, the tuned model algorithm is made up of a relatively large amount of mathematical operations which, in turn, require a large processor capacity.

Therefore we propose to solve the inverse heat diffusion problem with the use of an artificial neural network [17-21] that estimates the identified thermo-physical parameters [22-25] from measured temperature responses of the thermal probe $T_G(t)$ and the auxiliary thermometer $T_D(t)$, having a known amount of heat Q (repeatable in measurements) delivered by the probe to the sample.

5.1. Training of neural network

The training series for the network were generated by solving the direct heat diffusion problem using the finite element method. They comprise data for nine selected instants of the probe temperature $T_G(t)$ and the auxiliary thermometer temperature $T_D(t)$ waveforms and various combinations of coefficients a and λ . Each of the coefficients was given 10 values from the assumed interval: $a \in \langle 1 \div 3 \rangle \cdot 10^{-6} \text{ m}^2/\text{s}$ and $\lambda \in \langle 3 \div 5 \rangle \cdot 10^{-2} \text{ W}/(\text{m} \cdot \text{K})$. All combinations give in result 100 training series.

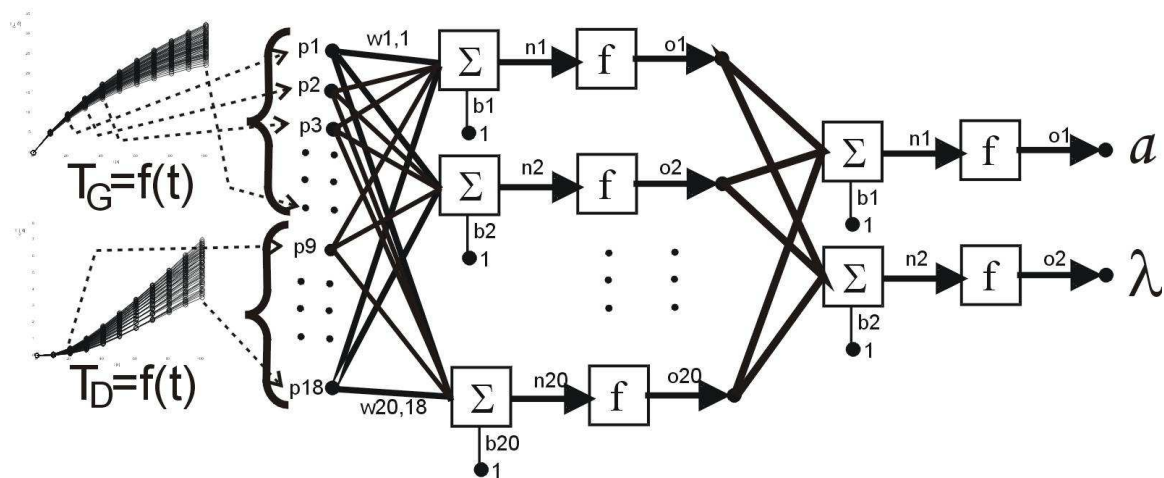

Fig. 9. A hypothetical architecture of the neural network with input and output quantities.

The way of presenting data $T_G(t)$ and $T_D(t)$ at the input of an exemplary neural network is illustrated in Fig. 9. On the basis of these data the network estimates the material thermal parameters. Having the input data $T_G(t)$, $T_D(t)$ for known, repeatable heat Q transferred from the probe and assuming boundary conditions on side surfaces of the sample (surface film conductance for natural convection: $a \in \langle 5 \div 30 \rangle \text{ W}/(\text{m}^2 \cdot \text{K})$), yields unique values of estimated coefficients a and λ [16]. The neural network used in the project had 18 inputs: 9 for selected instantaneous values of the probe temperature waveform $T_G(t)$ and the other 9 for instantaneous values of the auxiliary thermometer temperature $T_D(t)$. These temperatures are responses to the set and known thermal input from the probe. The training series of instantaneous temperatures $T_G(t)$ and $T_D(t)$ are presented in Fig. 10 and 11.

In order to determine an optimal configuration of the neural network, we carried out a lot of test simulations for different architectures of the network [19, 26]. The goal was to select the network structure as simple as possible to enable its easy software implementation on a simple 8-bit microprocessor. The network should approximate with sufficient accuracy the heat diffusion process for the coefficient inverse problem as well as suitably generalize the heat diffusion model so that the identification was insensitive to measurement errors in the input data as much as possible. Unfortunately, good capability of generalization of an ideal model not always goes hand in hand with low sensitivity to measurement errors occurring in practice in vectors of the input data.

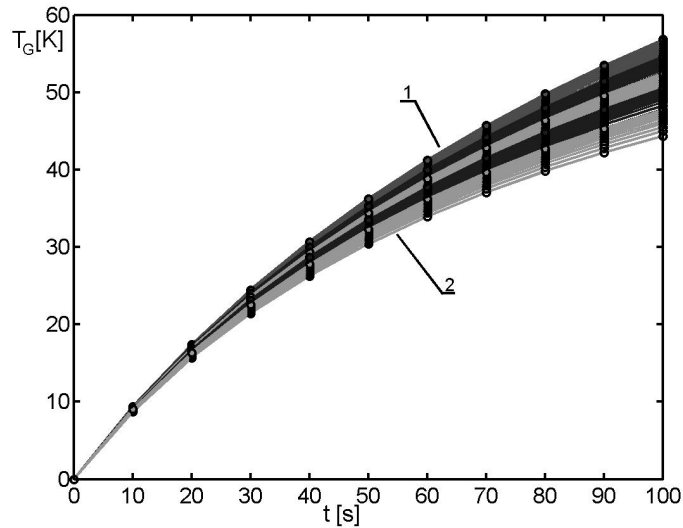

Fig. 10. Examples of training vectors made up of instantaneous values of the heating probe temperature $T_G(t)$. 1) $a = 1.0 \cdot 10^{-6} \text{ m}^2/\text{s}$, $\lambda = 3.0 \cdot 10^{-2} \text{ W}/(\text{m}\cdot\text{K})$; 2) $a = 3.0 \cdot 10^{-6} \text{ m}^2/\text{s}$, $\lambda = 5.0 \cdot 10^{-2} \text{ W}/(\text{m}\cdot\text{K})$.

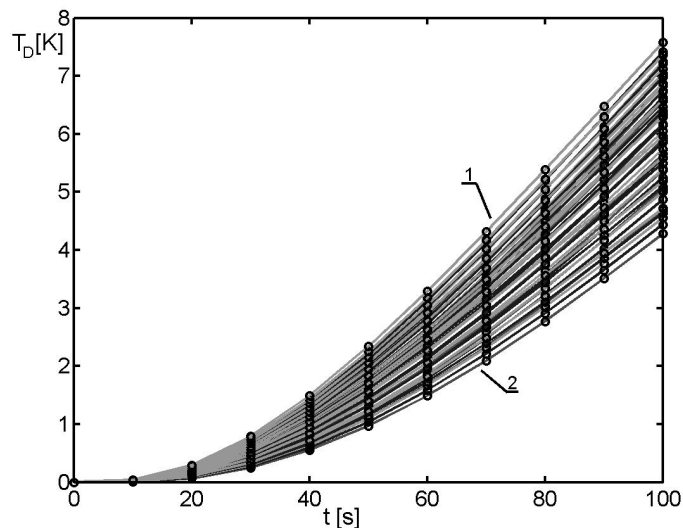

Fig. 11. Examples of training vectors made up of instantaneous values of the auxiliary thermometer temperature $T_D(t)$. 1) $a = 3.0 \cdot 10^{-6} \text{ m}^2/\text{s}$, $\lambda = 5.0 \cdot 10^{-2} \text{ W}/(\text{m}\cdot\text{K})$; 2) $a = 1.0 \cdot 10^{-6} \text{ m}^2/\text{s}$, $\lambda = 3.0 \cdot 10^{-2} \text{ W}/(\text{m}\cdot\text{K})$.

In further model research we investigated how the measurement errors of the input quantities affect values of the estimated thermal parameters [18]. Since the described measurement system is designed for industrial measurements, it was assumed that the sufficiently good uncertainty of the estimated thermal parameters should be of order of several percent.

The neural network chosen as an optimal one is a two layer nonlinear network consisting of 20 neurons with a hyperbolic tangent activation function in the input layer and 2 linear neurons in the output layer.

6. Prototype of the probe and the measurement system

The pictorial diagram of the built prototype of the measurement unit is shown in Fig. 12. The presented idea of the system is a subject of a patent application [27].

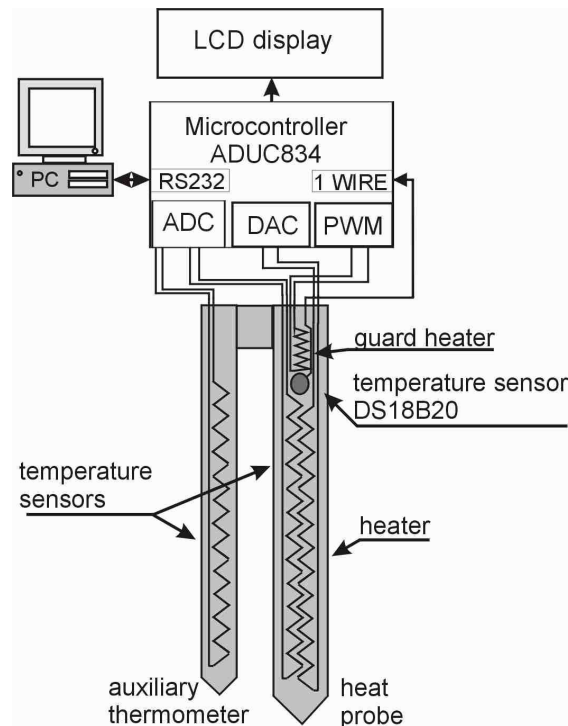

Fig. 12. Diagram of measuring system with an integrated hot probe and an auxiliary thermometer

The prototype system uses an 8-bit microcontroller: Analog Device ADUC834. The central unit of the microcontroller is based on the simple and well-known architecture of 8051. The distinctive features of this microcontroller family are good/high performance analog-to-digital converters, which can be applied to measurements and control. The ADUC834 microcontroller has an additional stable current source and an analog-to-digital converter (ADC) configured so that it is possible to connect a resistive transducer directly to the microcontroller. In the prototype of the system, resistive transducers of temperature probe T_H and auxiliary thermometer T_X are connected to the microcontroller's ADC. The third temperature sensor integrated with a 10-bit DS18B20 analog-to-digital converter is connected to the serial input of the microcontroller via a 1-wire interface. Due to the need of precise control of the heater probe thermal power P_G , the microcontroller on-chip digital-to-analog converter (DAC) is used with an appropriate voltage follower as a current amplifier. To control the guard heater, a PWM digital-to-analog converter of the microcontroller and a simple transistor chopper are used. The measuring system is equipped with a small keypad and an alphanumeric LCD display to allow communication with the user. The system can communicate with a PC by sending measurement data from the experiment through a standard RS232 interface.

The probe used currently was built by inserting several strands of copper wire with electrical insulation coating into a fine needle. In the proposed measurement system it is assumed that the temperature measured by the transducers does not exceed 100°C . Therefore, it is sufficient to use resistive temperature transducers made of copper, not platinum. Platinum would unnecessarily increase the cost of the system, moreover, it has a non-linear static characteristic $R = f(T)$ which would have to be corrected. The implementation of resistive temperature transducers (copper wire) arranged uniformly throughout the length of the heat probe and the additional thermometer is dictated by necessity of measuring the average temperature along the probe. Thermo-insulation material, such as foamed polystyrene, is not heterogeneous, because it is obtained as the result of press moulding of foamed polystyrene balls with a diameter of 2 to 5 mm approximately. Therefore, to correctly evaluate effective thermal parameters of a material, it is necessary to use samples much larger than the size of

their heterogeneities. The point measurement of temperature could indicate temperature gradients caused by the material non-homogeneity.

The temperature sensor DS18B20 is placed in the holder near the end of the thermal probe. Behind it, there is the handle protective heater with wound wire. The guard heater heats the handle so that the temperature of the heat probe T_G , indicated by the DS18B20 sensor, is equal to that measured by resistive temperature transducer T_H . Using compensation, the heat from the probe heater does not heat the handle. Due to the fact that during the measurement the handle can be in different ambient conditions, it is not possible to take into consideration in a mathematical model of the setup the heat escaping to the environment through the handle.

To plunge the probe and the auxiliary thermometer into the sample in parallel, it was necessary to use a special guide bar. The picture of the prototype probe with the guide bar is shown in Fig. 13.

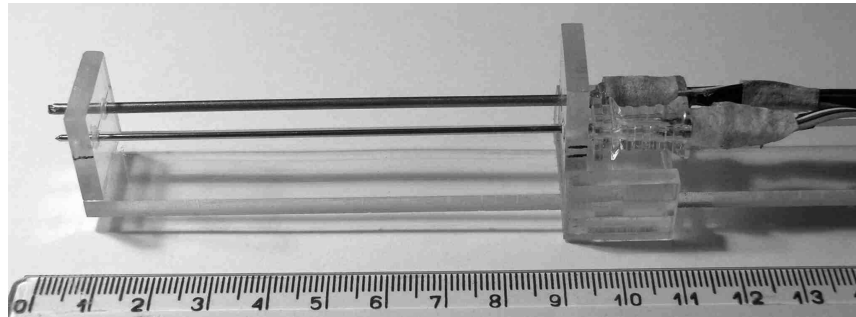

Fig. 13. Photo of the prototype measuring probe

The picture in Fig. 14 shows the prototype measurement system with a tested sample of foamed polystyrene.

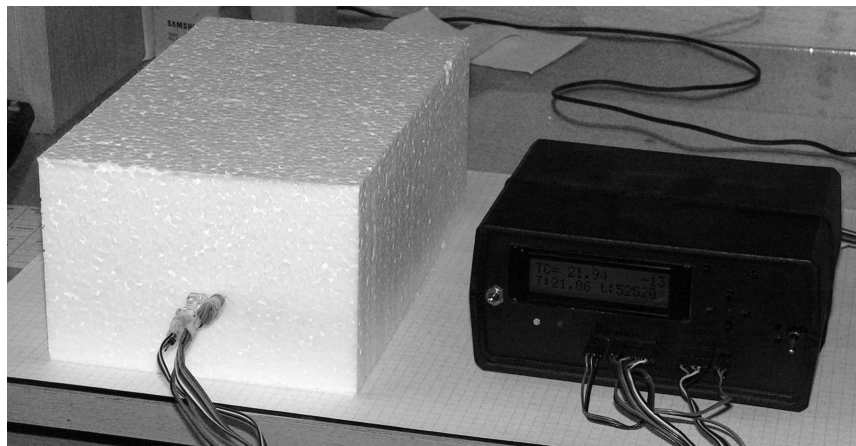

Fig. 14. Photo of the prototype measuring system with a sample of material

6.1. Experimental results

In experiments we used a sample of foamed polystyrene FS15 10x15x20 cm in size. The graphs in Fig. 15 present exemplary waveforms of the temperature rise of the thermal probe T_G , the auxiliary thermometer T_D and the guard heater T_O recorded for 100 seconds.

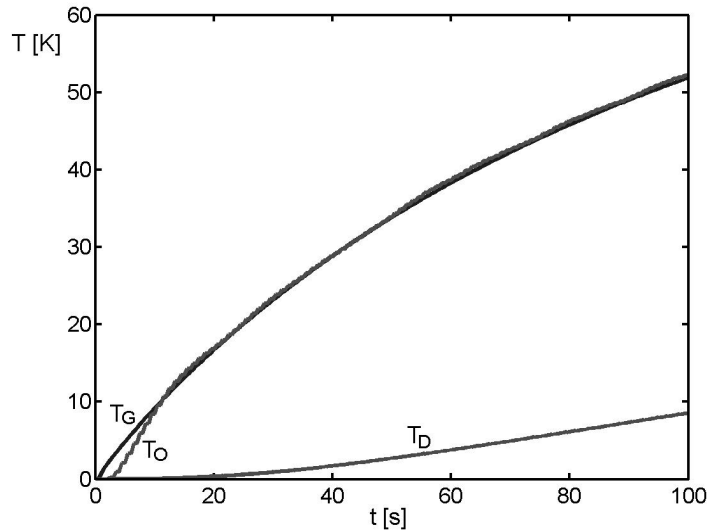

Fig. 15. Temperature rise of the hot probe T_G , the auxiliary thermometer T_D and the guard heater T_O for a time period of 100s

6.2. Results of a series of measurements

Experimental research comprised a series of 20 measurements and computations of the thermal parameters of a selected foamed polystyrene sample. Measurements were conducted in repeatable environmental conditions. The estimates of the parameters for successive repetitions of the test are collected in Table 1. The values are presented as three-digit numbers only for comparison of results obtained in each repetition of the measurement.

Table 1. Results of parameter estimation for foamed polystyrene

experiment number	$a \cdot 10^{-6}$, m^2/s	$\lambda \cdot 10^{-2}$, $W/m \cdot K$	$\rho c_p \cdot 10^4$, $J/m^3 \cdot K$
1	2.50	4.40	1.76
2	2.33	4.37	1.88
3	2.31	4.38	1.90
4	2.32	4.37	1.88
5	2.29	4.39	1.92
6	2.32	4.38	1.89
7	2.33	4.39	1.88
8	2.35	4.38	1.87
9	2.32	4.39	1.89
10	2.38	4.38	1.84
11	2.35	4.39	1.87
12	2.37	4.39	1.85
13	2.34	4.39	1.88
14	2.35	4.38	1.86
15	2.31	4.40	1.90
16	2.38	4.39	1.85
17	2.36	4.39	1.86
18	2.39	4.40	1.84
19	2.34	4.41	1.88
20	2.55	4.36	1.71
arithmetic average	2.36	4.38	1.86
standard deviation	$6.29 \cdot 10^{-8}$	$1.18 \cdot 10^{-4}$	$4.83 \cdot 10^2$

To verify results of these measurements, representative samples of foamed polystyrene from the lot used in our experiments were tested in the laboratory of the Military University of Technology, Warsaw. The value of the thermal conductivity evaluated in the verification test [3], $\lambda=0.0043 \pm 0.0001 \text{ W/(m}\cdot\text{K)}$, is close to the result obtained with the use of the prototype system presented in this work. On the other hand, the value of the thermal diffusivity evaluated using the impulse method [16], $a \approx (1\pm 4)\cdot 10^{-6}, \text{ m}^2/\text{s}$, is burdened with a large uncertainty, so in this case it is only an order-of-value estimate. This issue was discussed more extensively in [24].

7. Conclusions

The results presented in this work indicate the possibility of practical application of the presented idea of the measurement system with a thermal probe and neural network estimation, for solving the inverse problem. The proposed solution allows fast identification of material thermal parameters, if the experiment ensures repeatability of thermal input Q of the probe. However, the neural network is able to estimate parameters only from a specified interval of variation, used earlier for network training. The research proved that an artificial neural network can be useful in approximation of the coefficient inverse problem for the assumed two-dimensional model of the heat diffusion.

An unquestionable advantage of the proposed solution is the possibility of using thermometers of greater diameter that can be plunged into a specified cross-section of the tested sample. The method does not require building a special measurement setup. For the foredesign of the thermal probe with the auxiliary thermometer presented in the paper, the minimal transverse dimensions of a tested sample can be as small as 10x10 cm, and its thickness as small as 15 cm (negligible influence of assumed boundary conditions). It is also possible to test material in the form packed for distribution, e.g. 50x50x100 cm packages in the case of foamed polystyrene or rolled bales in the case of mineral wool. Moreover, materials can be tested directly on a building, because heat insulating layers thicker than 10 cm become more and more common.

Acknowledgements

This work was supported by the Ministry of Science and Higher Education of Poland under research grant No. N N505 3129 33 realized in years 2007-2009.

References

- [1] Al-Homoud, M. (2005). Performance characteristics and practical applications of common building thermal insulation materials. *Building and Environment*, 40, 353–366.
- [2] Chudzik, S., Minkina, W. *Method for determining thermal parameters*, patent PL Nr 193596 B1, Int. Cl.⁸ G 01N 25/18, G 01K 17/00. (in Polish).
- [3] Minkina, W., Chudzik, S. (2004). *Measurement of Thermal Parameters of Thermoinsulating Materials – Instrumentation and Methods*. Publishing House of Czestochowa University of Technology. Czestochowa. (in Polish)
- [4] Beck, J.V. (1985). *Inverse Heat Conduction*. A Wiley-Interscience Publisher.
- [5] Alifanov, O., Artyukhin, E., Rumyantsev, S. (1995). *Extreme Methods for solving Ill-Posed Problems with Applications to Inverse Heat Transfer Problems*. New York.
- [6] Blackwell, J.H. (1953). Radial-axial heat flow in regions bounded internally by circular cylinders. *Canadian Journal of Physics*, 31(4), 472-479.

- [7] Boer, J., Butter, J., Grosskopf, B., Jeschke, P. (1980). Hot wire technique for determining high thermal conductivities. *Refractories Journal*, 55, 22-28.
- [8] Sylos Cintra, J., Santos, W. (2000). Numerical analysis of sample dimensions in hot wire thermal conductivity measurements. *Journal of the European Ceramic Society*, 20, 1871-1875.
- [9] Ventkaesan, G., Guang-Pu Jin. (2001). Measurement of thermophysical properties of poliurethane foam insulation during transient method. *Int. J. Therm. Sci.*, 40, 133-144.
- [10] Xin-Gang Liang. (1995). The boundary induced error on the measurement of thermal conductivity by transient hot wire method. *Measurement Science and Technology*, 6(5), 467-471.
- [11] Huaqing Xie, Shuxia Cheng. (2001). A fine needle probe for determining the thermal conductivity of penetrable materials. *Measurement Science and Technology*, 12(1), 58-62.
- [12] Hammerschmidt, U., Sabuga, W. (2000). Transient hot wire (THW) method: uncertainty assessment. *International Journal of Thermophysics*, 21(6), 1255-1278.
- [13] Tavman, I.H., Tavman, S. (1999). Measurement of thermal conductivity of dairy products. *Journal of Food Engineering*, 41, 109-114.
- [14] ASTM D 5334-00. (2000). Standard test methods for determination of thermal conductivity of soil and soft rock by thermal needle probe procedure. ASTM, 100 Barr-Harbor Dr. West Conshocken. PA 19428-2059, 04.08.
- [15] ASTM D 5930-01. (2001). Standard test method for thermal conductivity of plastics by means of a transient line source technique. ASTM, 100 Barr-Harbor Dr., West Conshocken, PA 19428-2059, 14.02.
- [16] IEEE STD 442-1981 *IEEE guide for Thermal Resistivity Measurements*. The Institute of Electrical and Electronics Engineers, Inc. 345 East 47 Street, New York, NY 10017
- [17] Chudzik, S., Gryś, S., Minkina, W. (2009). The application of the artificial neural network and hot probe method in thermal parameters determination of heat insulation materials Part 1 – thermal model consideration. *Proc. of IEEE International Conference on Industrial Technology ICIT*. Melbourne, 1-6.
- [18] Chudzik, S. (2009). The idea of using artificial neural network in measurement system with hot probe for testing parameters of heat-insulating materials. *Measurement*, 42, 764–770.
- [19] Chudzik, S., Minkina, W., Gryś, S. (2009). The application of the artificial neural network and hot probe method in thermal parameters determination of heat insulation materials. Part 2 – application of the neural network. *Proc. of IEEE International Conference on Industrial Technology ICIT*. Melbourne, 1-5.
- [20] Daponde, P., Grimaldi, D. (1998). Artificial neural networks in measurements. *Measurement*, 23, 93-115.
- [21] Gajda, J. (2002). Uncertainty of an identification process. *Metrology and Measurement Systems*, 9(2), 89-101.
- [22] Gajda, J., Szyper, M. (1998). *Modelling and simulation of measurement systems*. AGH. Firma Jartek s.c.. Krakow. (in Polish)
- [23] Taler, J. (1995). *Theory and practice of identifications heat transfer processes*. Ossolineum, Wrocław. (in Polish)
- [24] Terpiłowski, J. (1991). Measurements of thermal diffusivity of solids. *Scientific Papers of the Technical University of Lodz*, 101(606), 161-191. (in Polish).
- [25] Minkina, W., Chudzik, S. (2003). Determination of thermal parameters of heat-insulating materials using artificial neural networks. *Metrology and Measurement Systems*, 10(1), 34-49.
- [26] Chudzik, S., Gryś, S., Minkina, W. (2009). Artificial neural networks in solution of inverse problem of heat diffusion. *PAK*, 55(2), 83-88. (in Polish).
- [27] Chudzik, S., Minkina, W. *Method for determining thermal parameters*. patent application P 382918. (in Polish).