

DOI: 10.1515/amm-2016-0191

A. SKRZYPCZYK*, H. DANIELEWSKI*#

PROPERTIES AND MICROSTRUCTURE OF LASER WELDED VM12-SHC STEEL PIPES JOINTS

Paper presents results of microstructure and tests of welded joints of new generation VM12-SHC martensitic steel using high power CO₂ laser (LBW method) with bifocal welding head. VM12-SHC is dedicated to energetic installation material, designed to replace currently used. High content of chromium and others alloying elements improve its resistance and strength characteristic. Use of VM12-SHC steel for production of the superheaters, heating chambers and walls in steam boilers resulted in various weldability researches. In article are presented results of destructive and non-destructive tests. For destructive: static bending and Vickers hardness tests, and for non-destructive: VT, RT, UT, micro and macroscopic tests were performed.

Keywords: laser welding, VM12-SHC martensitic steel, bifocal welding head, properties of pipe welds

1. Introduction

A power industry in Poland till 2020 predicts a substantial increase in energy consumption and in the related capital expenditures. Energy will be obtained mainly from the combustion of conventional fuels. Some about 60% of the capital expenditures will be spent on modernizations and reconstructions of the existing power units and on the construction of new ones with supercritical and ultrasupercritical parameters. This will require an application of high-temperature creep resistance and heat resistance materials [20-22].

In the power plants, the high alloy steels of new generation such as VM12-SHC have often been widely used. Due to high corrosion resistance and creep resistance in several structural applications with factors such as the additional and expensive requirements to prevent or delay the onset of corrosion and creep fatigue considering life cycle costs and environmental compatibility. Content of chromium, molybdenum and tungsten improves strength and anticorrosion parameters that extends operating times of power plants components [1,24]. VM12-SHC is designated to work in high steam parameters with temperature up to 650°C and pressure of 300 bar.

VM12-SHC martensitic steel is characterized as well weldable, however in order to avoid hot cracks in weld an additional preheat treatment and proper control of welding temperature are required. VM12-SHC have martensitic structure and like all martensitic steels require preheat treatment up to approximately 210°C [2]. In conventional welding process this operation is carried out via additional process such as conduction heating,

in laser welding preheating can be perform by defocusing laser beam [7]. Conventional methods of welding require proper prepare of joining edges by chamfering. Due to narrow width of the fusion zone proper fitting of joining edges is require (Fig. 1), by using bifocal welding system this requirement can be reduce. Paper presents results of LBW joining method of VM12-SHC new generation martensitic steel by using bifocal welding head and obtained tests of welded joints results.

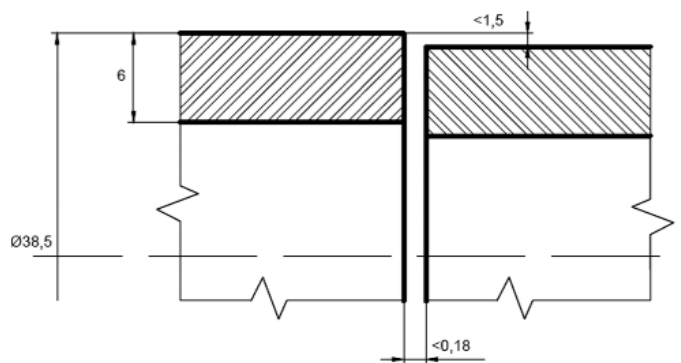

Fig. 1. Preparation of pipe stub edges for laser welding

VM12-SHC has been developed to replace currently used X10CrMoVNb9-1 and X20CrMoV11-1 steels with due to high content of carbon have limited weldability and tend to occur hydrogen cracks. Development of new generation materials such as VM12-SHC likewise new welding technologies including laser welding contributed to numerous studies.

* KIELCE UNIVERSITY OF TECHNOLOGY, 7th TYSIĄCLECIA P.P. AV. 25-314 KIELCE, POLAND

Corresponding author: hdanielewski@tu.kielce.pl

2. Characteristic of VM12-SHC

High temperature resistance characteristics of VM12-SHC results from contents of chromium and other alloying elements such as molybdenum (Table 1) improving creep resistance. Another alloying elements improving creep resistance as well as hardenability is tungsten. 12% of chromium increase corrosion resistance and hardenability of alloy. Slight content of carbon improve weldability of VM12-SHC contemporaneously limits risk to occur of hydrogen cracking. Boron is composition of VM12-SHC is intended to stabilize carbides forming. Occurrence of alloying element such as cobalt and vanadium improve strength characteristic particularly fracture toughness.

TABLE 1
Chemical composition of VM12-SHC

Element	Cr	Co	W	Si	Mn	V	Mo	C	B	Ni
Content min-max [%]	11-12	1.4-1.8	1.3-1.7	0.4-0.6	0.15-0.45	0.2-0.3	0.2-0.4	0.1-0.14	0.003-0.006	0.1-0.4

Martensitic steels require preheating treatment due to reduce temperature gradients, which may result in the hot crack [8,9]. Welded material have to be cool to completed martensitic transformation. Traditional welding method require lonealing in temperature of 740-780°C. Laser welding process thought to high power density takes much faster than a conventional processes such as TIG and MIG welding and results in narrow weld and heat affected zone. According to destination of joining element operating condition in justified cases post welding heat treatment can be omitted. Paper presents result of no post welded heat treatment process samples, tested according to stringed requirements of PN-EN ISO 13919-1 standards.

3. Laser welding of VM12-SHC steel pipes

Laser circumferential welding of VM12-SHC pipes with thickness of 6mm, outer diameter of 38.5 mm and length of 150 mm was performed. Welding device was high power CO₂ laser Trumpf TruFlow 6000 with maximum power of 6kW on additional rotary axis of TruLasercell 1005 work center.

TABLE 2

Laser welding parameters

Welded material	Type of laser	Power [kW]	Velocity [r/min]	Frequency [kHz]	Type of welding head
VM12-SHC	CO ₂	6	8	50	bifocal

Pipes was fix on developed pipe clip with one side spring clamp and placed in turning roll. Inside pipes due to protection

of weld root shielding gas was conveyed. For welding bifocal welding head with bisected mirror was used [5]. Welding was performed with two foci orientation: perpendicular(option 1) and parallel (option 2) to weld in order to verify bifocal welding head orientation on quality of the obtained joints (Fig. 2). In table 2 based laser parameters of welded pipe stub was presented.

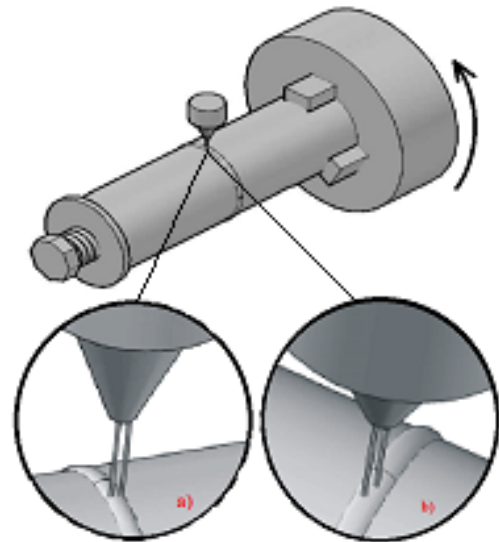

Fig. 2. Schematic of circumferential laser welding pipe stand, foci orientation of bifocal welding head a) option 1, b) option 2

Due to highest ionization potential Helium with coaxial-blown of 20 l/min was used to protect face of weld. However weld root was shielded by gaseous mixture of 70% of Helium and 30% of an Argon. Preheating treatment up to 210°C was perform by defocusing laser beam. Obtained results of tests weld joints refer to joints without post weld treatment.

4. Non destructive tests

Due to circumferential butt laser joints the most commonly welding defects may occur are incompletely filled or shrinkage of groove, porosity(Fig. 4a and 5a) and lack of side or poor fusion. Due to rating of weld quality require using of several tests of welds methods. Paper presents results of visual testing (VT), radiographic testing (RT) and ultrasonic testing (UT) of welds.

4.1. Visual testing VT

Visual testing was conducted according to PN-EN ISO 17637 [13]. Acceptable quality level identified according to PN-EN ISO 13919-1 [14]. Welds made at B quality level (stringent requirements) subjected to further testing. Fig. 3 shown weld made in option 2 welding head manipulator orientation, qualified to B quality level.

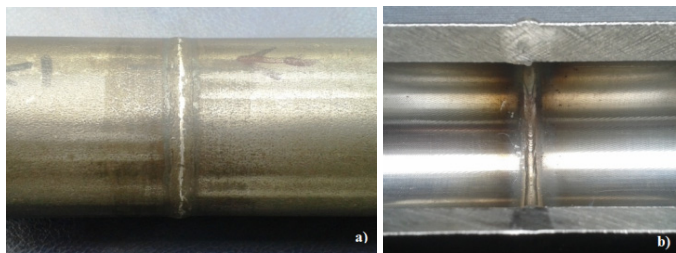

Fig. 3. Face of weld (a) and root of weld (b) after cutting of part of joint

4.2. Radiographic testing RT

Radiographic testing was conducted according to PN-EN ISO 17636-1 [15]. Acceptable quality level identified according to PN-EN ISO 10675 [14].

Source of radiation was ERESKO 42F X-ray tube with effective focal point of 3×3 mm. To visualize Kodak Industrex MX 125 class C3 photographic film was used. Distance between X-ray manipulator and pipe was 500 mm. Exposition parameters: 140 kV, 4 mA, t = 1 mm. Fig. 4 shown radiograms for correct welds. No outer defects were identified, slight gas pore inside of weld was detected.

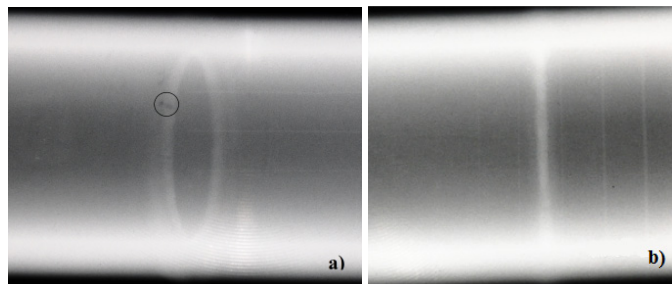

Fig. 4. Radiographic testing a) – option 1, b) – option 2 of weld

4.3. Ultrasonic testing UT

Due to perform testing ultrasonic flaw detector USM 35S of GE (Krautkramer) industry was used. Echo-sounding technique by (MSEB-4) front and (MWB 70–4) side measuring head using DGS ($D_{DSR} = 0.7$ mm) scale. Fig. 5 shown typical detection of gas pore (Fig. 5a) and lack of defects (Fig. 5b).

High compliance of radiographic and ultrasonic tests results were achieved.

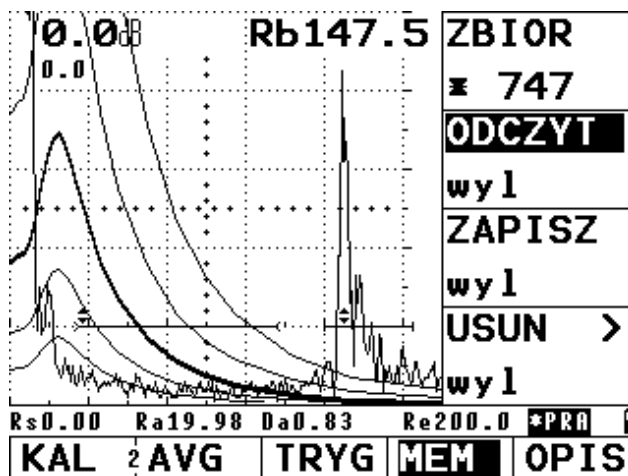
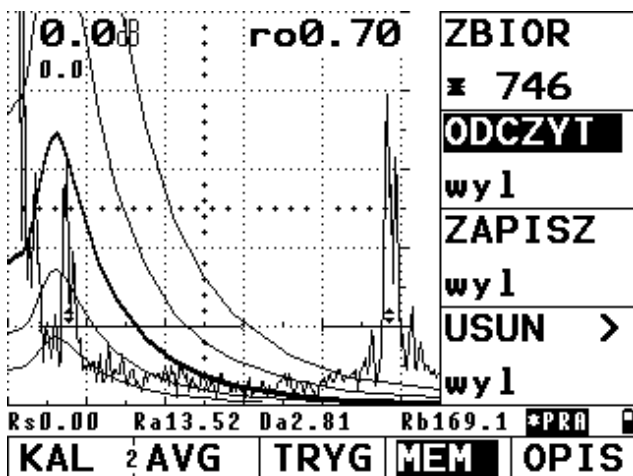

Fig. 5. Ultrasonic tests result

5. Destructive testing of welded joints

Martensitic structure and alloying elements increase strength characteristic of VM12-SHC (Table 3). Strength properties of weld have crucial impact resulting in acceptance level of joints.

TABLE 3

Mechanical properties of VM12-SHC

Type	R_e [MPa]	R_m [MPa]	A [%]
Value	≥450	620-850	≥19

Melting and crystallization process changes the crystalline structure affecting on strength characteristics. Due to welding boiled installation significant is that welded material and heat affected zone (HAZ) have similar properties as base material

(BM) [3,4,6,10]. Due to investigate quality of receiving joints with no postheating treatment static tensile test, static bending test (Fig. 6) and microhardness testing in cross-section was performed.

5.1. Bending test

Technological bending test of weld ductility was conducted according to PN-EN ISO 5173 [12]. Due to weld zone and HAZ in laser welding are very narrow tests were performed on non standard samples size. Static bending test was performed on INSTRON 8501 testing machine (Fig. 6). Diameter of bending die was 40 mm. For both technological option of welding close bend test was received.

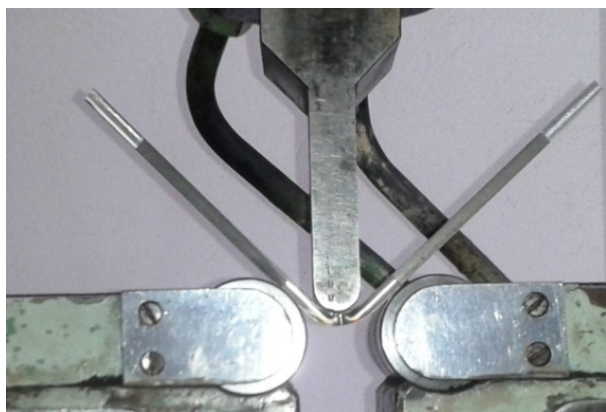

Fig. 6. Side bend test

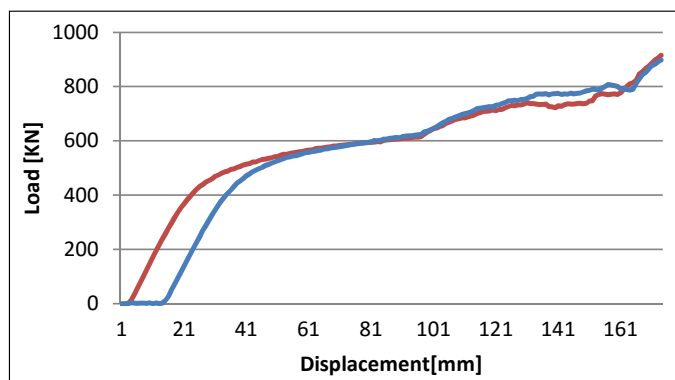

Fig. 7. Static close bend test diagram

Fig. 7 shown very similar results for both welding head orientation options. Lower banding forces in option 1 shown slightly lower properties of receiving weld joints.

5.2. Static tensile test

Static tensile test of weld (R_m) was conducted according to PN-EN ISO 4136 [11]. Measured was compared to minimal required value based on material properties (Table 3). Tensile test was performed on ZD-100 testing machine. Results of static tensile tests were given in table 4.

Technological tensile tests was performed for weld and welding joints (Figs. 8, 9). Results for both options shown good strength properties. Failure of welded joints occurred outside HAZ, failure of weld occurred in interfacial layer of HAZ and weld. Results of static stretching test was shown in table 4.

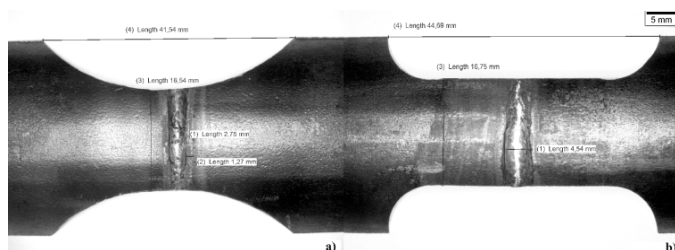

Fig. 8. Samples for tensile test, a) weld, b) welded joints

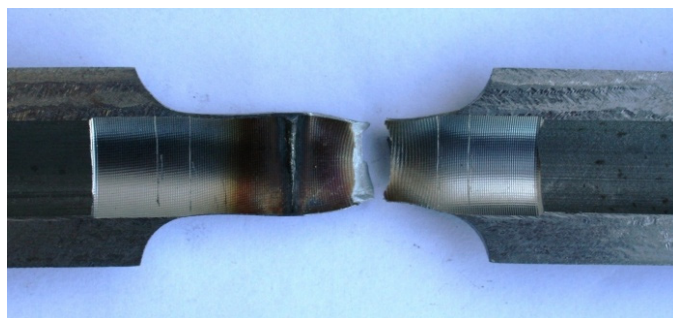

Fig. 9. Failure of a test piece of tensile welding joints

TABLE 4

Static stretching tests results

Lp.	Size		Stretching		Place of rupture
	$a \times b$ mm	S_0 mm^2	F_m kN	R_m N/mm^2	
Option 1 weld	17.0×5.92	101	88.0	871	outside weld
Option 2 weld	16.9×5.86	99	86.0	869	outside weld
Option 1 joint	16.9×5.91	100	92.0	920	outside weld
Option 2 joint	17.2×5.92	102	96.0	941	outside weld

5.3. Hardness test

Hardness test was carried out for both options according to PN-EN ISO 6507-1 [17]. Fig. 10 shown distribution of test points, Figs. 11 and 12 shown results of hardness.

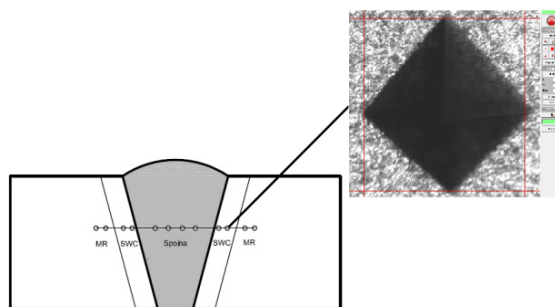

Fig. 10. Hardness test point distribution

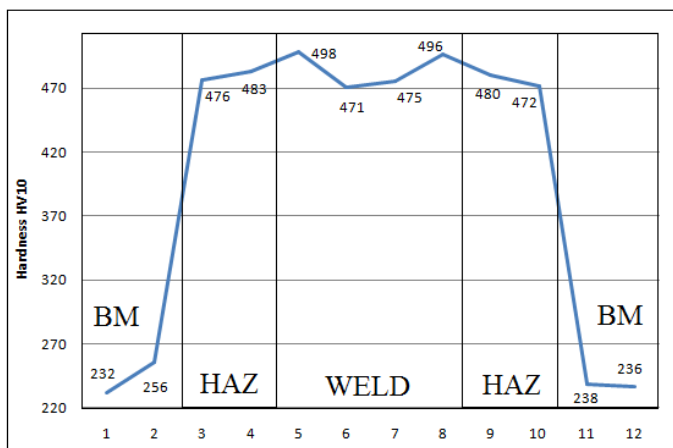

Fig. 11. Hardness distribution in weld cross-section for option 1

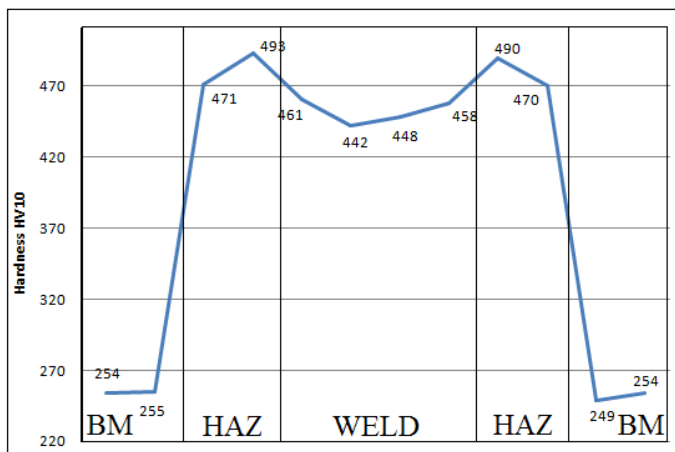

Fig. 12. Hardness distribution in weld cross-section for option 2

Hardness test results shown strengthening in weld and HAZ. Due to both options of welding head orientation hardness distribution is slightly different. For option 1 hardness of weld and HAZ is more uniform than in option 2, however option 2 shown inconsiderable smaller value of hardness in weld than in HAZ towards for option 1, that may indicate of smaller temperature gradients for technological option 1. According to PN-EN ISO 15614-11 maximum allowable limit of Vickers hardness HV10 after heat treatment is 380 [18], however results shown values approximating for 495 HV10. According to standard of PN-EN ISO 15614-11 exceed maximum value of hardness for B quality level and post welded heat treatment are required.

6. Metallographic test

Metallographic tests was conducted according to PN-EN ISO 17639 [19]. Micro and macroscopic tests using Hirox KH-8700 confocal digital microscope and JSM 50 scanning electron microscope was performed. Macrostructure with magnification

of 35× (Fig. 13) and microstructure with magnification of 2000× (Figs. 14, 15) was shown.

6.1. Macroscopy

Fig. 13 presents macrostructure results of both technological option of welded joints. Macroscopic image shown properly formed of welded joints in cross-section. Welds profiles shown dissimilarity in crystallization process for both technological welding head orientation options.

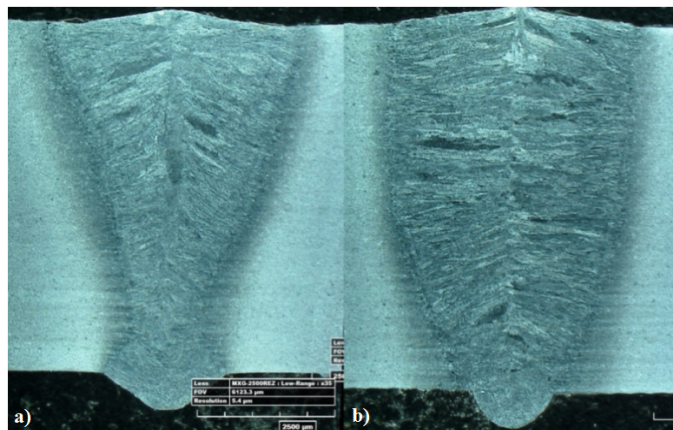

Fig. 13. Macrostructure of weld joints a) option 1, b) option 2 – Hirox confocal digital microscope, magnification 35×

6.2. Microscopy

Typical images of BM, HAZ and weld microstructures for laser welded VM12-SHC martensitic steel was presented. Fig. 14 shown microstructure of joint welded in option 1 of bifocal welding head configuration, Fig. 15 shown microstructure for option 2. Obtained weld joints characterized by the occurrence of no welding defects. Typical structure of VM12-SHC welding joints is martensite with carbides precipitates.

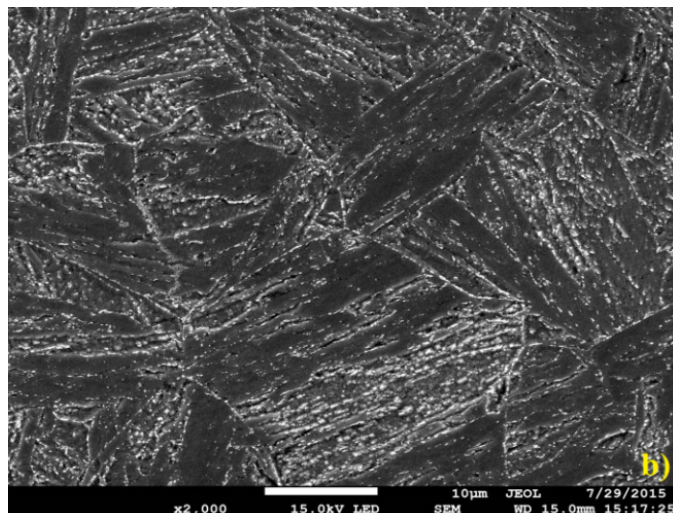
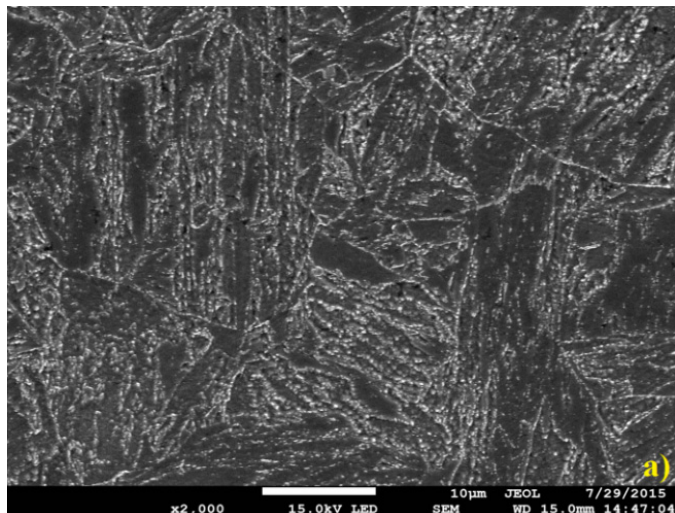

Fig. 14. Microstructure of BM – a) option 1, b) option 2 – JEOL electron microscopy, magnification of 2000×

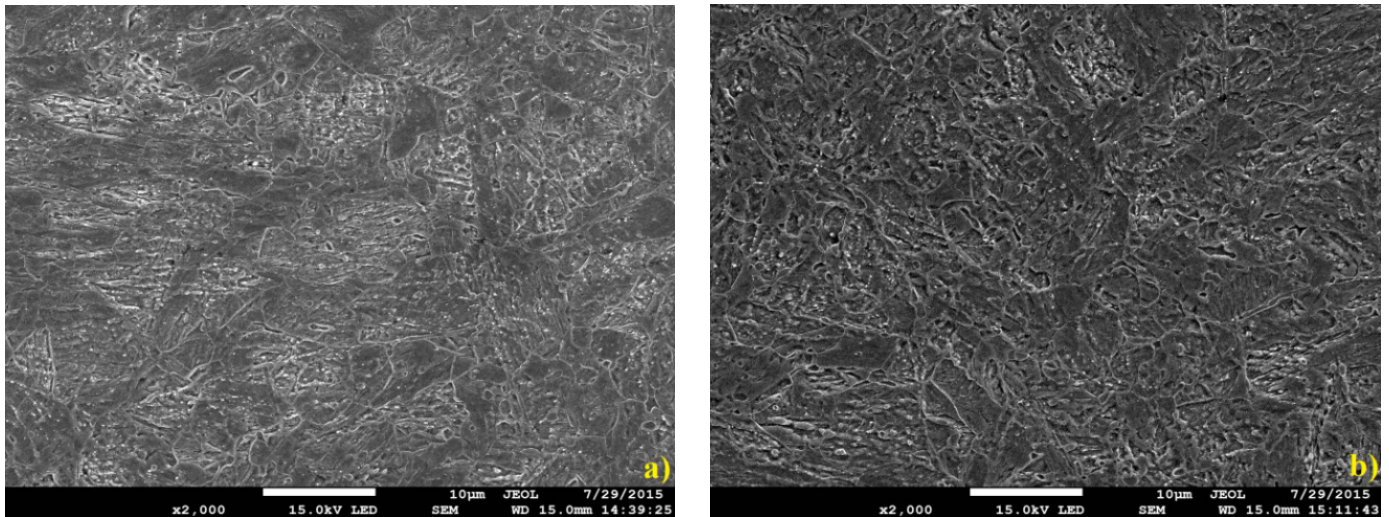

Fig. 15. Microstructure of HAZ – a) option 1, b) option 2 – JEOL electron microscopy, magnification of 2000×

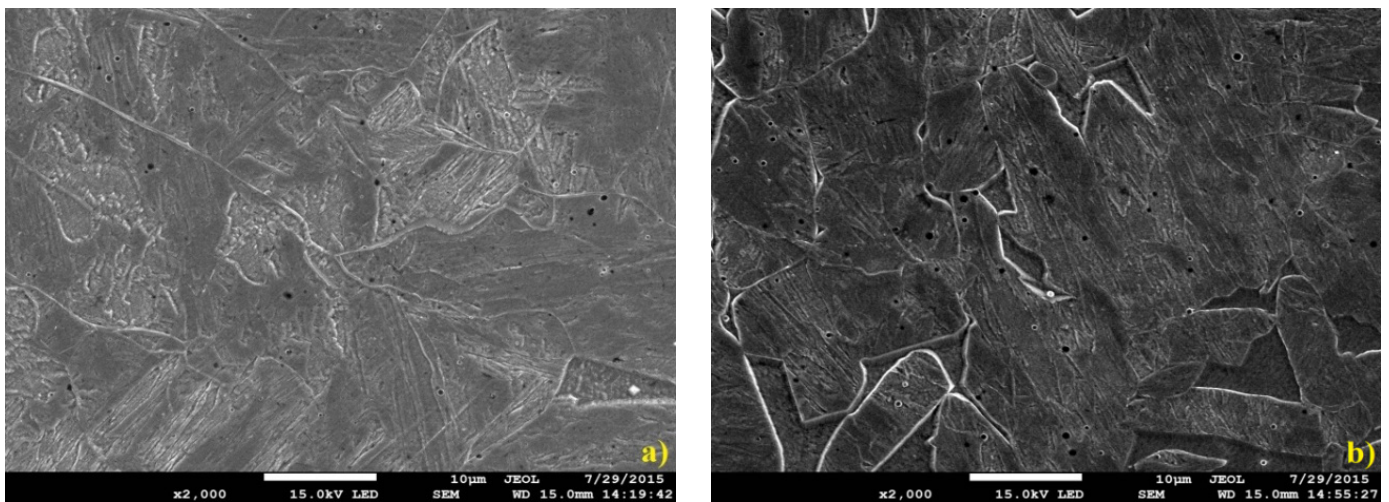

Fig. 16. Microstructure of weld – a) option 1, b) option 2 – JEOL electron microscopy, magnification of 2000×

7. Summary

According to PN-EN ISO 13919-1, stringent requirements of B quality level for 1 and 2 technological option was obtained. Destructive and nondestructive tests confirmed proper strength characteristics, and correct cross-section welds construction. Post weld treatment of obtained laser welded joints might improve strength properties and lower hardness of HAZ and fusion zone to required according to PN-EN ISO 15614-11 norm value of 380HV. Value of 495 exceed maximum hardness contained in the standards and additional post welding heat treatment are required.

Joints of laser welded VM12-SHC martensitic steel pipes shown good strength characteristic, and luck of detected by destructive and nondestructive methods welding defects. Obtained results due to high repeatability of laser welding process makes that more research of weldability of other type of steels with supercritical parameters should be perform.

Acknowledgements

Research carried out in the NCBiR project nr PBS1/B5/13/2012: „Laser welding technologies for energy and the environment”

REFERENCES

- [1] M. Scendo, M. Chat, B. Antoszewski, Oxidation Behaviour of Laser Welding of TP347HFG and VM12-SHC Stainless Steels, *Int. J. Electrochem. Sci.* **10** (2015).
- [2] A. Radziszewska., S. Kaç, M. Solecka, Characterization of microstructure and properties of laser welded boiler pipes, *NM-NT* (2015).
- [3] M. Urzyncok, K. Kwieciński, M. Szubryt, Testing of pipe joints in VM12-SHC martensitic steel, *Bulletin of the Institute of Welding*, 42-46, (2010).

- [4] U. Dilthey, A. Ghandehari, W. Bleck, I. Budak, Mechanical – technological properties of beam welded high and ultra high strength steels, *Zeitschrift für Metallkunde* **92**(3), 221-225 (2001).
- [5] M. Urzunicok, K. Kwieciński, J. Słania, Application of new gma welding methods used in prefabrication of P92 (X10CrWMoVNb9-2) pipe butt welds, *Przegląd Spawalnictwa* **81**(10), 13-19 (2009).
- [6] W. Pawełczyk, K. Wojsyk, The properties of homogeneous and heterogeneous joints of VM12 and X20CrMoV12-1 steels, *Przegląd Spawalnictwa* **4**, 5-9 (2015).
- [7] A. Kimpel, Laser Technologies, Gliwice (2012).
- [8] G. Golański, A. Kępa, Modern steels for energetic, characteristics, Częstochowa (2011).
- [9] J. Dobrzański, New-generation creep-resistant martensitic steel containing 9-12%Cr for elements of steam superheater of boilers operating at supercritical parameters, work of IMŻ **4**, (2011).
- [10] K. Pańcikiewicz, S. Kwiecień, E. Tasak, The properties of joints of 7CrMoVt1B10-10 (t24) steel after heat treatment, *Przegląd Spawalnictwa* **8**, 8-14 (2010).
- [11] PN-EN ISO 4136: Destructive tests on welds in metallic materials – Transverse tensile test.
- [12] PN-EN ISO 5173: Destructive tests on welds in metallic materials – Bend tests.
- [13] PN-EN ISO 17637: Non-destructive testing of welds – Visual testing of fusion-welded joints.
- [14] PN-EN ISO 13919-1: Welding – Electrons and laser beam welded joints – Guidance on quality levels for imperfections – Part 1: Steel.
- [15] PN-EN ISO 17636-1: Non-destructive testing of welds – Radiographic testing – Part 1: X- and gamma-ray techniques with film.
- [16] PN-EN ISO 10675-1: Non-destructive testing of welds – Acceptance levels for radiographic testing – Part 1: Steel, nickel, titanium and their alloys.
- [17] PN-EN ISO 6507-1: Metals – Vickers hardness test method – Part 1: Test method.
- [18] PN-EN ISO 15614-11: Specification and qualification of welding procedures for metallic materials – Welding procedure test – Part 11: Electron and laser beam welding.
- [19] PN-EN ISO 17639: Destructive tests on welds in metallic materials – Macroscopic and microscopic examination of welds.
- [20] M. Zeman, S. Błacha, Weldable new generation martensitic creep-resisting steels, *Przegląd Spawalnictwa* **86**(4), (2014).
- [21] A. Strang, V. Vodarek, H.K.D.H. Bhadeshia, Modelling of Microstructural Evolution in Creep Resistant Materials, The Institute of Materials, London, 129-150 (1999).
- [22] J. Brózda, New generation high-temperature creep resistant steels, their weldability and properties of the welded joints, *Bulletin of the Institute of Welding* **1**, (2004).