

archives  
of thermodynamics

Vol. **36**(2015), No. 4, 49–64

DOI: 10.1515/aoter-2015-0032

## Recuperator with microjet technology as a proposal for heat recovery from low-temperature sources

JAN WAJS<sup>a1</sup>  
DARIUSZ MIKIELEWICZ<sup>a</sup>  
ELŻBIETA FORNALIK-WAJS<sup>b</sup>  
MICHAŁ BAJOR<sup>a</sup>

<sup>a</sup> Gdansk University of Technology, Faculty of Mechanical Engineering, Department of Energy and Industrial Apparatus, Narutowicza 11/12, 80-233 Gdansk

<sup>b</sup> AGH University of Science and Technology, Faculty of Energy and Fuels, Department of Fundamental Research in Energy Engineering, Mickiewicza 30, 30-059 Kraków

**Abstract** A tendency to increase the importance of so-called dispersed generation, based on the local energy sources and the working systems utilizing both the fossil fuels and the renewable energy resources is observed nowadays. Generation of electricity on industrial or domestic scale together with production of heat can be obtained for example through employment of the ORC systems. It is mentioned in the EU directive 2012/27/EU for cogenerative production of heat and electricity. For such systems the crucial points are connected with the heat exchangers, which should be small in size but be able to transfer high heat fluxes. In presented paper the prototype microjet heat exchanger dedicated for heat recovery systems is introduced. Its novel construction is described together with the systematical experimental analysis of heat transfer and flow characteristics. Reported results showed high values of the overall heat transfer coefficient and slight increase in the pressure drop. The results of microjet heat exchanger were compared with the results of commercially available compact plate heat exchanger.

**Keywords:** Heat exchanger; Microjet technology; Heat recovery; Wilson plot method

---

<sup>1</sup>Corresponding Author. E-mail: janwajs@pg.gda.pl

## Nomenclature

$A$	–	heat transfer area (PHE)
$b$	–	height of plate heat exchanger channel
$C, C_H$	–	constants
$D, D_p$	–	diameter of water inlet
$k$	–	overall heat transfer coefficient
$L_h$	–	distance between PHE inlets and outlets
LMTD	–	mean logarithmic temperature difference
$L_p$	–	working length of PHE
$L_w$	–	width of PHE
$L_v$	–	total length of PHE
$n$	–	power of function
$P_c$	–	distance between PHE channels
$q$	–	heat flux
$R^2$	–	coefficient of determination
$R_{\alpha C}$	–	convective resistance of cold water
$R_{\alpha H}$	–	convective resistance of hot water
$R_\lambda$	–	conduction resistance of tube wall
Re	–	Reynolds number
$R_k$	–	overall thermal resistance
$t$	–	thickness of heat conducting wall
$t_C$	–	temperature of cold water
$t_H$	–	temperature of hot water
$u_H$	–	velocity of hot water
$V_{COLD}$	–	flow rate of cold water
$V_{HOT}$	–	flow rate of hot water
$x$	–	abscissa
$y$	–	ordinate

## Greek symbols

$\alpha_C$	–	heat transfer coefficients of cold water
$\alpha_H$	–	heat transfer coefficients of hot water
$\beta$	–	characteristic angle of PHE
$\delta$	–	thickness of partition
$\lambda$	–	thermal conductivity of partition
$\nu$	–	kinematic viscosity

## 1 Introduction

Technical development is strictly connected with the energy utilization. It is observed that demand of energy is increasing every year, therefore in parallel to the technological discoveries, new better ways of energy use are looked for and investigated. Dispersed generation systems, based on the organic Rankine cycle (ORC), are one of the most promising solutions.

One of the technical problems connected with an application of ORC in the low-temperature waste energy recovery systems is to equip this system with the highly efficient heat exchangers for example the evaporators, condensers or regenerators. The aim of ensuring the high efficiency of these heat exchangers is coming from the economy and the common tendency to miniaturization of the devices. The construction of compact heat exchangers should go in parallel with keeping the heat flux as high as possible. It is known that in the recuperators the heat transfer coefficients on both sides (heating and heated) of partition are the most significant and determined their capacity. It is also important that the overall heat transfer coefficient depends on the lowest value between both mentioned heat transfer coefficients. Therefore a special care should be taken to the heat transfer conditions on the weaker side of partition inside mentioned above the evaporators/condensers or regenerators.

In the scientific literature, description of the active and passive techniques of heat transfer intensification can be found [1]. All methods can be generally divided on:

- active (additional energy is required),
- passive (mostly corresponded to the surface extension or introduction of new substances),
- combined (parallel application of active and passive methods or various passive ones).

Due to the requirement of additional energy in the case of active methods, they are very often applied in the phase change processes, however their control is very difficult.

Passive heat transfer enhancement is directly connected with the heat transfer process between the fluids through partition wall. Heat flux exchanged between the hot and cold fluids depends on the overall heat transfer coefficient, temperature difference between both wall sides and heat transfer area. Intensification of heat transfer can be obtained by a surface extension (eg., fins) or by increasing the overall heat transfer coefficient (eg., flow turbulization).

In the case of microjet heat exchanger, laminar fluid film on the wall (separating the hot and cold fluids) is disturbed by the fluid streams hitting the wall. Due to that the fluid is in direct contact with wall and reduces the temperature difference between the wall and itself. This technology is especially useful for the low mass flow rates and/or for small temperature

differences. Described mechanism was implemented in the innovative construction of heat exchanger and presented as patent no. P.404601 [2]. It was dedicated to the cogeneration technology for covering the heat and electrical energy demand of the individual and industrial consumers, however its applications are not limited only to that.

In this paper the systematic experimental analysis of assembled heat exchanger are described. One phase convection heat transfer was considered so far and such parameters as heat transfer and overall heat transfer coefficients or pressure drop were looked for. The results of prototype heat exchanger analysis are presented, discussed and accompanied by the comparison with commercially available compact plate heat exchanger (PHE).

## 2 Microjet heat exchanger (MJHE)

Figure 1 presents schematic view of microjet heat exchanger with the heating and heated media perforation openings and heat conducting wall. The perforation openings are marked as broken lines, while the full lines represent solid walls. Detail geometrical characteristics is described in Tab. 1. The photography of assembled prototype is shown in Fig. 2.

The length of heat conducting wall was 0.281 m, outer diameter 0.018 m, giving in result overall heat transfer area of about 0.015 m<sup>2</sup>. In both perforation openings were made holes of 0.001 m diameter, generating the microstreams of fluid. The other technical data of presented heat exchanger were included in the patent application [2] and in the publications [3,4].

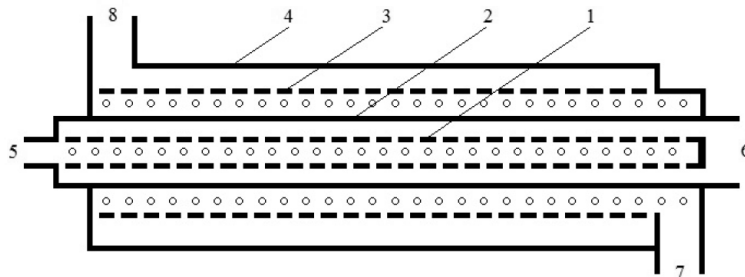

Figure 1: Schematic view of MJHE: 1 – perforation opening of heating medium, 2 – heat conducting wall, 3 – perforation opening of heated medium, 4 – shell, 5 – inlet of heating medium, 6 – outlet of heating medium, 7 – inlet of heated medium, 8 – outlet of heated medium.

Table 1: Geometrical characteristics of MJHE heat transfer area.

Dimension	Size
length of heat conducting wall	0.281 m
outer diameter of heat conducting wall	0.018 m
thickness of heat conducting wall $t$	0.001 m
diameter of perforation opening hole	0.001 m
overall heat transfer area	0.015 m <sup>2</sup>



Figure 2: Photography of MJHE prototype.

### 3 Experimental apparatus

The test stand was constructed at Gdansk Technical University, Department of Energy and Industrial Apparatus. It allowed investigation of convective heat transfer between the streams of heating and heated media with utilization of various types heat exchangers. Schematic view of test stand is shown in Fig. 3.

Tap cold water was divided into two streams: one was directly going to heat exchanger, while second one – to electrical heater, where it obtained needed conditions of the heat exchanger hot side inlet. In both streams of water the fine filters were installed to purify efficiently media and to protect all other stand devices. The electrical heater of 45 kW power was precisely controlled and the settings could be obtained smoothly due to an auto-transformer. The volume flow rates were measured by the rotameters V31 (Heinrichs) of 1st class accuracy. Temperature of hot and cold water at the inlets and outlets was measured by T-type thermocouples, whose signals were acquired by system CROPICO (3001 TC/PT 100) with a calculated accuracy at the level of 0.3 K.

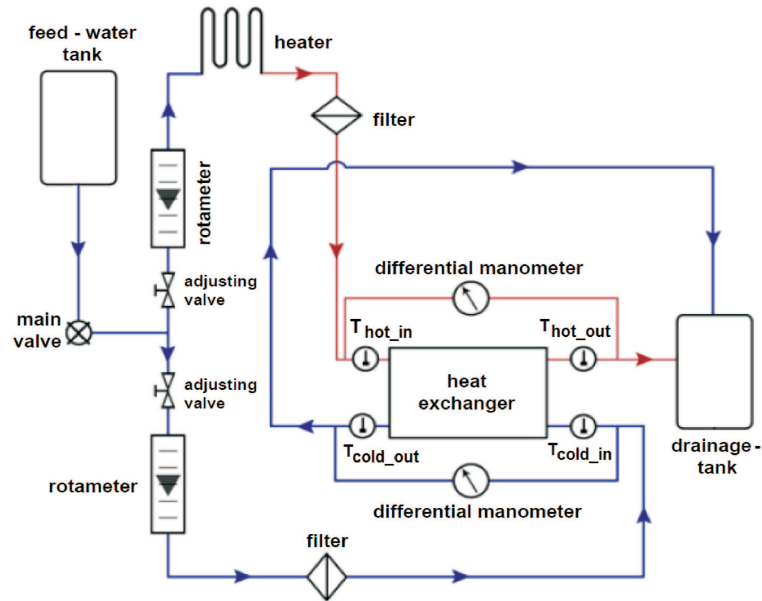

Figure 3: Schematic view of the test stand.

The pressure drop in both heat exchanger sides (hot and cold) was measured by differential pressure transducer (HubaControl) of 1% of accuracy.

## 4 Results and discussion

### 4.1 Heat transfer analysis

The analysis of counter current microjet heat exchanger was conducted for three values of inlet hot water temperature: 40, 60 and 90 °C, while temperature of cold water was constant and equal to 8 °C. Following parameters for hot and cold water were measured: inlet and outlet temperature, and volume flow rate.

The overall heat transfer coefficient was calculated in the basis of Wilson plot method [5–7], which seemed to be in Authors' opinion the most suitable for heat exchangers of complex geometry [8,9]. Wilson's approach was concentrated at first on the estimation of overall heat exchanger thermal resistance and then its division on particular resistances. Such approach followed by simple calculation led to the determination of heat transfer coefficients.

Total thermal resistance of heat exchanger consisted of the convective resistances of hot and cold water sides accompanied by the conduction resistance through the partition heat conducting wall in accordance with the following formulas:

$$R_k = R_{\alpha_C} + R_\lambda + R_{\alpha_H}, \quad (1)$$

$$R_k = \frac{1}{k}, \quad R_{\alpha_C} = \frac{1}{\alpha_C}, \quad R_\lambda = \frac{\delta}{\lambda}, \quad R_{\alpha_H} = \frac{1}{\alpha_H}, \quad (2)$$

where  $R_k$  represents the overall thermal resistance,  $k$  is the overall heat transfer coefficient,  $R_{\alpha_C}$  and  $R_{\alpha_H}$  indicate the convective resistances of cold and hot water, respectively,  $\alpha_C$  and  $\alpha_H$  are the heat transfer coefficients of cold and hot water, respectively,  $\lambda$  designates the thermal conductivity of partition, while  $\delta$  its thickness.

Utilizing the values of measured parameters and the thermal balance of heat exchanger the overall thermal resistance could be obtained from equation

$$R_k = \frac{A \cdot LMTD}{Q}, \quad (3)$$

where  $A$  indicates the heat transfer area,  $LMTD$  denotes the mean logarithmic temperature difference and  $Q$  represents the transferred heat rate.

To find the values of hot and cold water heat transfer coefficients, two series of measurements were conducted. At first stage the flow rate of hot water was varied, while the flow rate of cold water was kept constant. In the second measurement series the situation was opposite, it meant that the flow rate of cold water was varied, while the flow rate of hot water was kept constant.

Analyzing the first case (constant value of the cold water mass flow rate), the overall heat transfer coefficient changed in accordance to the changes of hot water heat transfer coefficient, when other parts of Eq. (1) remained constant:

$$R_{\alpha_H} = \frac{1}{\alpha_H} \neq const, \quad (4)$$

$$R_{\alpha_C} + R_\lambda = \frac{1}{\alpha_C} + \frac{\delta}{\lambda} = C = const, \quad (5)$$

where  $C$  indicates the constant.

Wilson [5] introduced following correlation connecting the heat transfer coefficient with the medium velocity and then correlation describing overall thermal resistance:

$$\alpha_H = C_H u_H^n, \quad (6)$$

$$R_k = \frac{1}{C_H u_H^n} + C, \quad (7)$$

where  $C_H$  denotes the constant,  $u_H$  – velocity of hot water and  $n$  is the power of function depending on the flow characteristics, and for fully developed turbulent flow it is equal to 0.8.

Equation (7) can be written in the form of linear function, where  $y$  represents an ordinate, while  $x$  – an abscissa:

$$y = R_k, \quad x = \frac{1}{u_H^n}, \quad y = \frac{1}{C_H}x + C, \quad (8)$$

which allowed the calculation of constants  $C_H$  and  $C$  with utilization of linear regression. When the mentioned constants were known it was possible to calculate the series of hot water heat transfer coefficient depending on its flow rate, (Eq. (6)), and one value of cold water heat transfer coefficient according to formula

$$\alpha_C = \frac{1}{C - \frac{\delta}{\lambda}}. \quad (9)$$

The analysis undertaken in the second stage of measurements was analogical with the first one and helped to calculate series of cold water heat transfer coefficient depending on its flow rate and one hot water heat transfer coefficient.

The heat transfer coefficient calculations by Wilson plot method were conducted for the wall tube thickness of 1 mm. The wall material (cooper) has the thermal conductivity,  $\lambda$ , equal to 385 W/(mK). For example, for the cold water the straight line described by formula (8) was plotted in Fig. 4, where  $C=2.84 \times 10^{-4}$  and  $1/C_H=2.25 \times 10^{-4}$ .

The exemplary calculation results of the heat transfer coefficient in hot and cold passes of microjet heat exchanger are shown below. Their values versus Reynolds number are presented in Fig. 5. It was done for series with hot water temperature equal to 90°C. The Reynolds number was defined as

$$\text{Re} = \frac{uD}{\nu}, \quad (10)$$

where  $D$  indicates the diameter of water inlet, and  $\nu$  represents the kinematic viscosity.

The thermal analysis was done from the heat removal point of view (for example cooling of water vapor), when the source of constant temperature cold water of various heat flux density is available. The thermal characteristics (overall heat transfer coefficient versus the Reynolds number) of



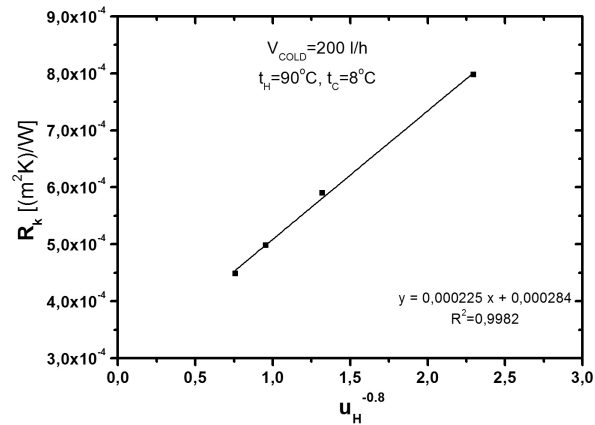

Figure 4: Experimental points and the corresponding linear regression.

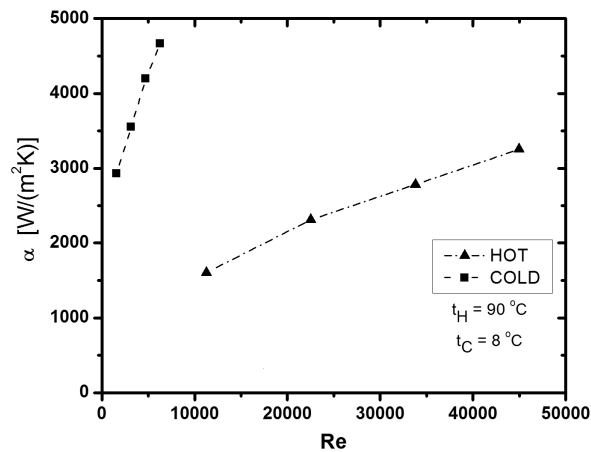

Figure 5: Heat transfer coefficient versus Reynolds number – hot water temperature of 90 °C and cold water of 8 °C.

microjet heat exchanger for three analyzed temperatures of hot water and various values of cold water flow rate are shown in Figs. 6–9.

The overall heat transfer coefficient is increasing together with an increase in the hot water Reynolds number and also mass flow rate of cold fluid. These results are obvious. The interesting point is that the increase of overall heat transfer coefficient is the highest at the lowest tempera-

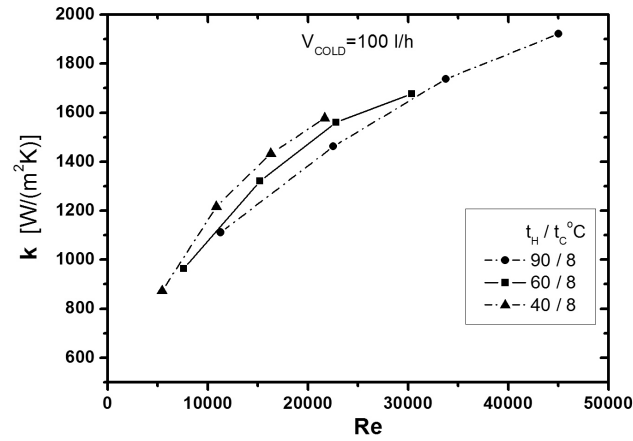

Figure 6: Heat transfer coefficient versus the hot water Reynolds number at 100 l/h of cold water.

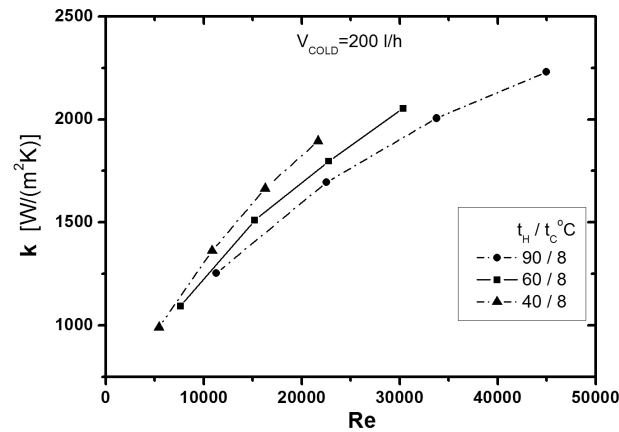

Figure 7: Heat transfer coefficient versus the hot water Reynolds number at 200 l/h of cold water.

ture (40 °C) of hot water. It means that the conditions in this case were highly improved due to the generation of microstreams hitting the partition. Therefore the statement written in Section 1 that the microjet heat exchanger is especially useful for small temperature differences is proved. The real performance of analyzed prototype will be shown in Section 4.3.

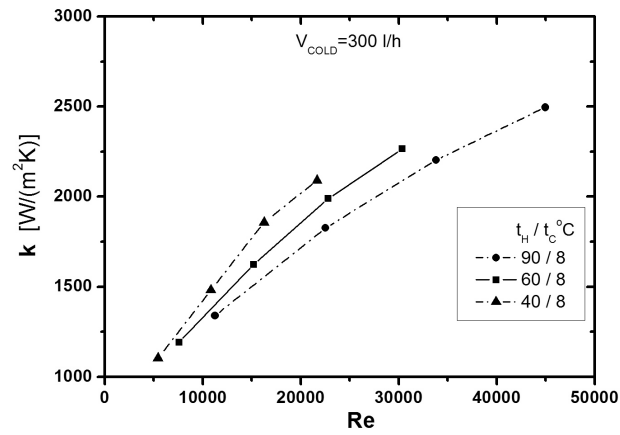

Figure 8: Heat transfer coefficient versus the hot water Reynolds number at 300 l/h of cold water.

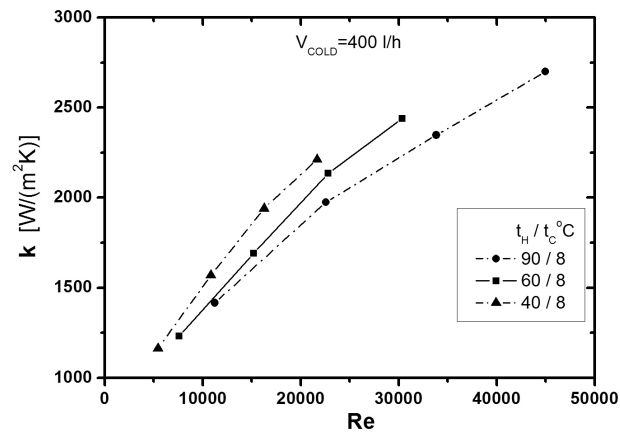

Figure 9: Heat transfer coefficient versus the hot water Reynolds number at 400 l/h of cold water.

## 4.2 Flow characteristics

The analysis of flow resistance was done at constant temperature of heat exchanger both sides equal to  $10 \pm 1^\circ\text{C}$ . The heat exchanger was placed in horizontal position to omit the gravitational part of pressure loss. The results are presented in Fig. 10. It can be observed that the pressure loss

at cold side was about two times higher than at the hot side. In Authors opinion it was directly connected with the geometry of cold water inlet and outlet. They were perpendicular to the flow direction. It can be concluded that the pressure loss generated at the media inlets and outlets are dominating in such construction.

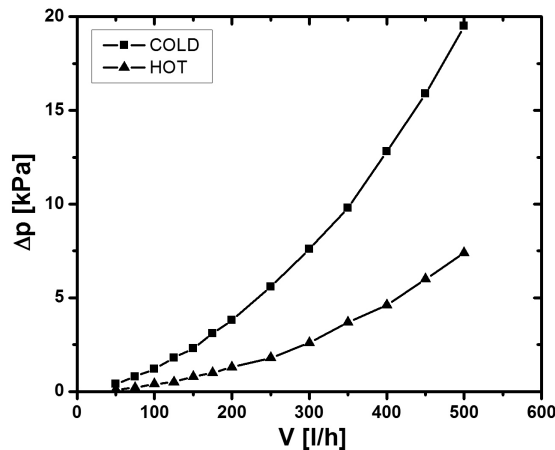

Figure 10: Flow characteristics of microjet heat exchanger.

### 4.3 Comparison with compact plate heat exchanger (MJHE)

The best way to get the real information of microjet heat exchanger efficiency is to compare it with another heat exchanger. In this section MJHE results were compared with the results obtained for commercial compact plate heat exchanger. It should be emphasized that plate heat exchanger (PHE) was analyzed on the same test stand [8].

The commercial plate heat exchanger (S4A-IG16-12-TLA-LIQUID) in a single pass, U-arrangement, is shown in Fig. 11. It consisted of 12 stainless steel plates (AISI 316) of  $5 \times 10^{-4}$  m thickness. The total heat transfer area was equal to  $0.468 \text{ m}^2$ . Its geometrical details are described in Tab. 2.

The plate heat exchanger was analyzed in similar to microjet heat exchanger thermal conditions. This means that temperature of hot water was in the range  $85\text{--}91 \text{ }^\circ\text{C}$ , while temperature of cold water was equal to  $10 \text{ }^\circ\text{C}$ . The results of heat transfer analyses of both heat exchangers are presented in the form of heat flux not to take into consideration the heat transfer area,

Table 2: Geometrical characteristics of PHE.

Dimension	Size
inlet diameter $D_p$	0.280 m
chevron angle $\beta$	$60^\circ$
total length of heat exchanger, $L_v$	0.385 m
working length of heat exchanger, $L_p$	0.358 m
width of heat exchanger, $L_w$	0.110 m
distance between inlets and outlets, $L_h$	0.070 m
height of the channel, $b$	0.003 m
thickness of heat conducting wall, $t$	$5 \times 10^{-4}$ m
distance between the channels, $P_c$	0.008 m
overall heat transfer area	0.468 m <sup>2</sup>

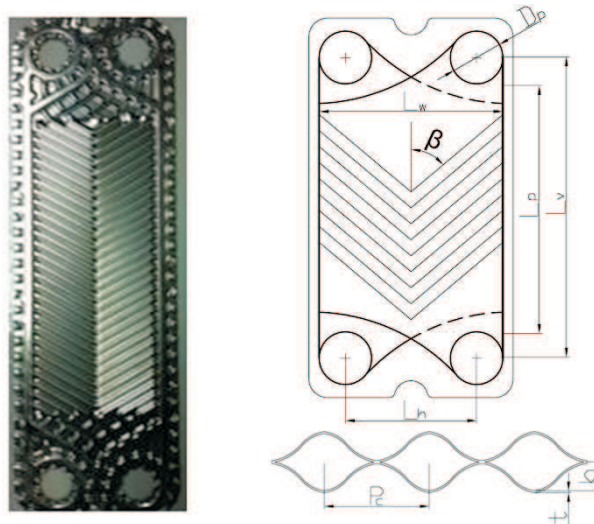

Figure 11: Compact plate heat exchanger.

which was different. The comparison of results is presented in Figs. 12–14. It could be observed that microjet heat exchanger was able to transfer about 5 times higher heat flux density than the plate one for each hot water flow rate.

In Fig. 15 the comparison of both heat exchangers flow characteristics is shown. The pressure loss analysis of plate heat exchanger was conducted on

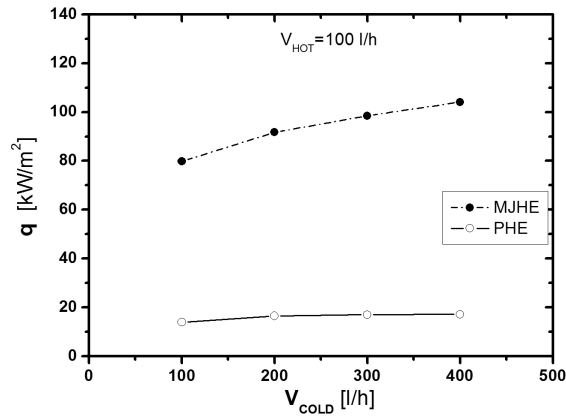

Figure 12: Heat flux versus the cold water flow rate at 100 l/h of hot water.

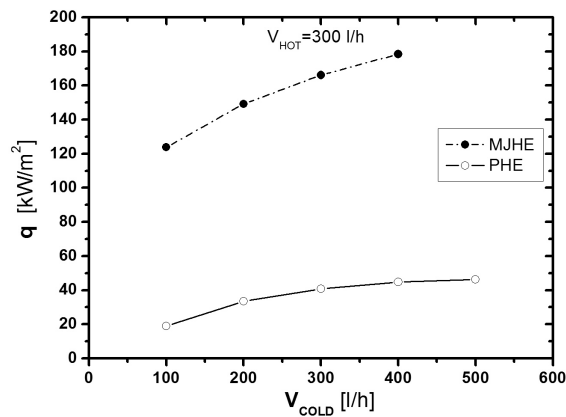

Figure 13: Heat flux versus the cold water flow rate at 300 l/h of hot water.

three plates unit at constant temperature of 10 °C in the horizontal position. The results represented the pressure loss in hot/cold fluid passage, because the geometry of both ways was the same, so the flow resistance was also the same.

The results of microjet heat exchanger took much lower values than in the case of plate one. The flow resistances were two times higher (cold side) and four time higher (hot side) for commercially available plate heat exchanger.

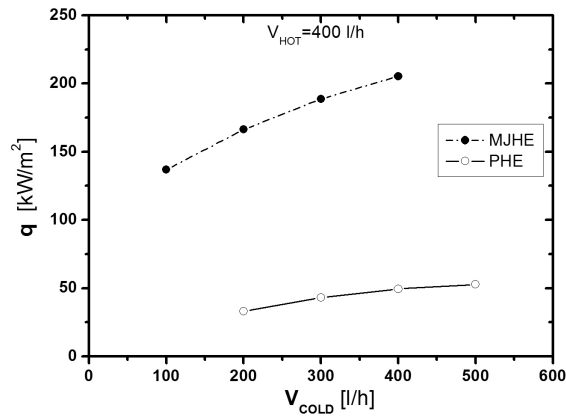

Figure 14: Heat flux versus the cold water flow rate at 400 l/h of hot water.

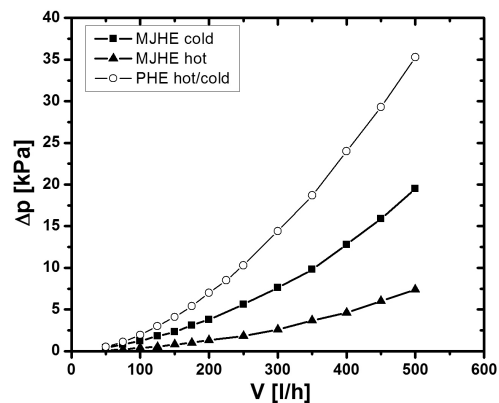

Figure 15: Flow characteristics comparison.

## 5 Conclusions

The innovative construction of microjet heat exchanger was introduced. The heat transfer and flow systematical analyses were performed and the results presented in this paper. Comparison with the commercial plate heat exchanger was done. The results showed about five times higher values of heat flux density transferred by the microjet unit than the plate one and about two-times smaller pressure loss.

The results are very promising especially in the area of ORC, however

the microjet heat exchanger construction has an universal character and it can be applied in any other applications.

**Acknowledgements** The results presented in this paper were partially obtained from research work cofinanced by the National Centre of Research and Development in the framework of Contract SP/E/4/65786/10 – Strategic Research Programme ‘Developing integrated technologies of fuel and energy production from biomass, agricultural wastes and other resources’ and partially from statute activity of Faculty of Mechanical Engineering of Gdansk University of Technology.

*Received 10 August 2015*

## References

- [1] KREITH F. *et. al.*: *Heat and Mass Transfer. Mechanical engineering handbook*. CRC Press LLC, 1999.
- [2] WAJS J., MIKIELEWICZ D., FORNALIK-WAJS E.: *Microjet heat exchanger of cylindrical geometry, dedicated both to the general applications and heat recovery from low temperature waste energy sources*. Patent application P.404601, 2013 (in Polish).
- [3] WAJS J., MIKIELEWICZ D., BAJOR M.: *Design and construction details of analyzed microjet heat exchanger*. Rep. IFFM PASci 1059/13, Gdańsk 2013 (in Polish).
- [4] WAJS J., MIKIELEWICZ D., BAJOR M.: *Preliminary flow characteristics analysis of microjet heat exchanger*. Rep. IFFM PASci 216/2014, Gdańsk 2014 (in Polish).
- [5] WILSON E.E.: *A basis for rational design of heat transfer apparatus*. Trans. ASME **37**(1915), 47–82.
- [6] MIKIELEWICZ J.: *Application of Wilson metod for calculation of heat transfer coefficient*. Technika Chłodnicza i Klimatyzacja **6**(1995), 215–216 (in Polish).
- [7] FERNÁNDEZ-SEARA J., UHÍA F., SIERES J., CAMPO A.: *A general review of the Wilson plot method and its modifications to determine convection coefficients in heat exchange devices*. Appl. Therm. Eng. **27**(2007), 2745–2757.
- [8] WAJS J., MIKIELEWICZ D.: *Effect of surface finish on heat transfer performance of plate heat exchanger*. In: Proc. 9th Int. Conf. Heat Transfer, Fluid Mechanics and Thermodynamics (HEFAT 2012), Malta 2012.
- [9] WAJS J., MIKIELEWICZ D.: *Influence of metallic porous microlayer on pressure drop and heat transfer of stainless steel plate heat exchanger*. Appl. Therm. Eng. **93**(2016), 1337–1346, <http://dx.doi.org/10.1016/j.applthermaleng.2015.08.101>.